





ABOUT US

Our founder Mustafa SIMSEK, started the production of cutting insert holders equipment for CNC lathes and milling cutter in an area of 50 m², in 2004. Since our establishment, we have been making continuous R&D and technological investments and continues our production in an area of 15.000 m² with its engineers and 120 experienced personnel and more than 6000 product types. SMOXH Cutting Tools, which has made an indelible impression in Turkey and in the world, has become the brand preferred by end users all over the world.

SMOXH cutting tools have gained serious demand in the Turkish market by taking a great majority of the tool sector share.

We deliver 60% of our production to our users all over the world, especially in the European market.

The fact that SMOXH is the preferred brand today is due to the fact that it has reached the highest levels at the point of both cost and quality. SMOXH has made a name for itself in Turkey and around the world as a result of our investments.

We, as SMOXH, have participated in social responsibility projects with the investments we have made in education and has opened the door to raising qualified generations in the future by establishing SMOXH Academy.

SMOXH Cutting Tools are sure that the key to success is "WE", not me. For this reason, we would like to thank all our dealers, our users and most importantly, our colleagues, who contributed to this success.

MUSTAFA SIMSEK

The founder of SMOXH Cutting Tools

HAKKIMIZDA

2004 Yılında kurucumuz Mustafa ŞİMŞEK tarafından 50m² alanda CNC torna ve frezeler için kesici uç bağlama ekipmanları üretimine başlamıştır, kurulduğu günden bu zamana kadar sürekli AR-GE ve teknolojik yatırımlar yaparak 15.000 m² alanda mühendisleri ve alanında tecrübeli 120 personeli ve 6000 i aşkın ürün çeşidi ile üretimine devam etmektedir.

Türkiye'de ve Dünyada adından söz ettiren SMOXH Kesici Takımlar tüm dünya çapında son kullanıcılar tarafından tercih edilen marka haline gelmiştir.

SMOXH kesici takımlar Türkiye pazarında takım sektörünün büyük çoğunluğunu alarak ciddi talep toplamıştır.

Üretiminin %60 lık kısmını başta Avrupa pazarı olmak üzere tüm Dünya'da kullanıcılarına ulaştırmaktadır.

SMOXH'un bugün tercih edilen marka olması hem maliyet hem de kalite noktasında en üst seviyelere ulaşmış olmasından kaynaklanmaktadır. SMOXH yapmış olduğu yatırımlar ile Türkiye ve Dünyanın göz bebeği haline gelmiştir.

Eğitime Yapmış olduğu yatırımlar ile sosyal sorumluluk projelerinde iştirak etmiş ve SMOXH Akademiyi kurarak gelecekte nitelikli nesiller yetişmesine kapı aralamıştır.

SMOXH Kesici Takımlar başarının anahtarının ben değil BİZ ilkesinden geçtiğinden emindir bu sebeple bu başarıda emeği geçen tüm bayilerine, kullanıcılarına ve en önemlisi birlikte yürüdüğü mesai arkadaşlarına yüreктen teşekkür eder.

Mustafa ŞİMŞEK

SMOXH Kesici Takımlar Kurucusu



the best
value of
process





| | |
|-----|---------------------------|
| 14 | T Systems External Tools |
| 22 | P Systems External Tools |
| 26 | M Systems External Tools |
| 28 | C Systems External Tools |
| 31 | S Systems External Tools |
| 52 | T Systems Internal Tools |
| 55 | P Systems Internal Tools |
| 58 | M Systems Internal Tools |
| 59 | C Systems Internal Tools |
| 60 | S Systems Internal Tools |
| 83 | BladeTools |
| 85 | External Grooving Tools |
| 94 | Swiss Type Grooving Tools |
| 96 | Face Grooving Tools |
| 103 | Internal Grooving Tools |
| 109 | Extrenal Threading Tools |
| 110 | Intrenal Threading Tools |
| 144 | 90 Milling Tools |
| 195 | 45 Milling Tools |
| 210 | Copy Milling Tools |
| 218 | Ball Nose End Mills |
| 227 | High Feed Milling Tools |
| 249 | Moduler Mill Holders |
| 250 | T Slot Mills |
| 252 | Dove Mills |
| 253 | Disc Mills |
| 254 | Chamfering Tools |
| 255 | Adjustable Boring Bars |
| 262 | U-Drills |
| 291 | MultiCut |

A

B

C

D

E

F

G

H

I

J

External Turning Tools

Internal Turning Tools

External Parting and Grooving Tools

Internal Grooving Tools

Threading Tools

Milling Tools

Copy Milling Tools

High Feed Milling Tools

Slot and Chamfering Mills

U-Drills

Dışçap Tornalama Takım Tutucu kodlamaları / External tool Holder Code System(ISO)

| | | | | | | | | |
|---|--------------------------------|-----------------------------|--|----------------------------|------------------------------------|----------------------------------|------------------------------|---|
| 1 | 2 | 3 | 4 | 5 | 6 | 7 | 8 | 9 |
| T | D | J | N | R | 25 | 25 | M | 15 |
| Elmas Sıkma sistemi Clamping system of insert | Elmas şekli Shape of insert | Tutucu Tipi Holder Style | Elmas boşaltma açısı Clearance Angle of insert | Takım Yönü Hand of Tool | Şaft Yüksekliği Height of Shank | Şaft Geniřliđi Width of Shank | Takım Boyu Length of tool | Elmas kesme uzunluđu Length of Insert Cutting Edge |

1 Elmas Sıkma Sistemleri / Clamping Method of Insert
T D J N R 25 25 M15

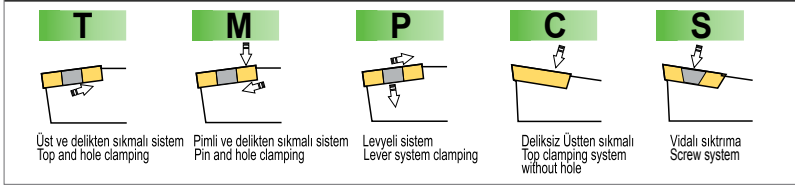

2 Elmas Şekli / Insert Shape
T D J N R 25 25 M15

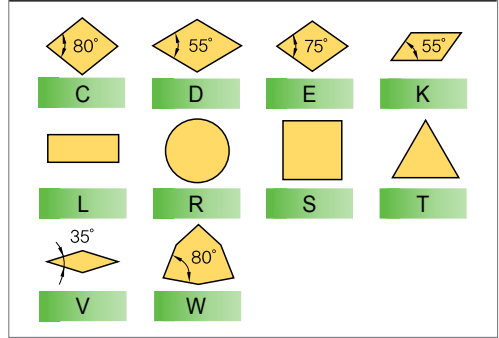

3 Tutucu Tipi / Holder Style
T D J N R 25 25 M15

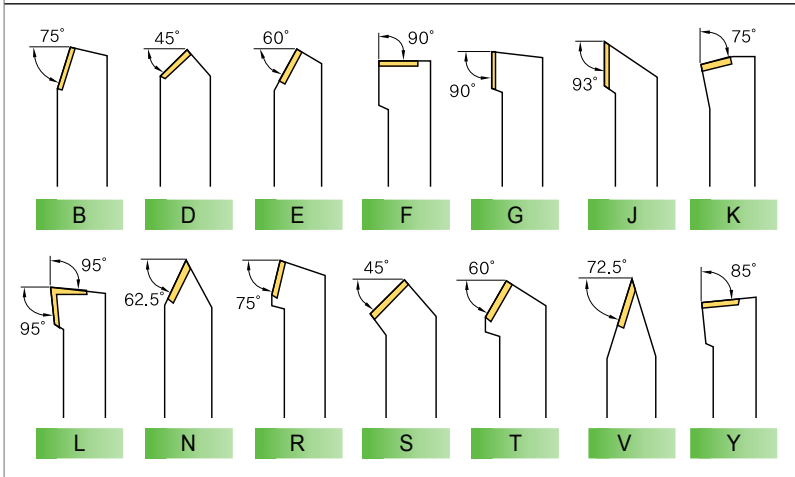

4 Clearance Angle of Insert
T D J N R 25 25 M15

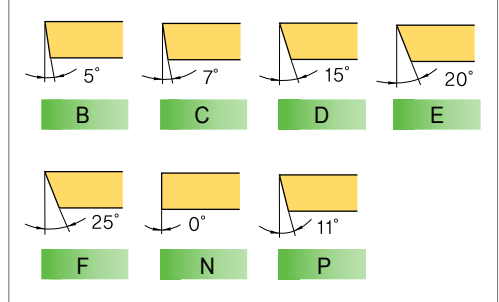

5 Takım Yönü / Hand of Tool
T D J N R 25 25 M15

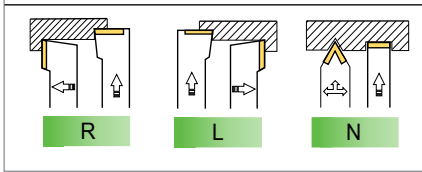

6 Şaft Yüksekliği / Height of Shank
T D J N R 25 25 M15

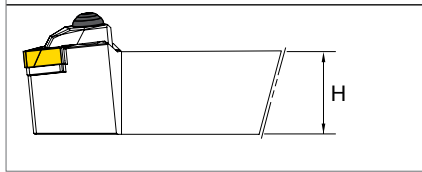

7 Şaft Geniřliđi / Width of Shank
T D J N R 25 25 M15

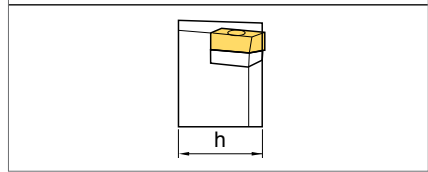

8 Takım Boyu / Length of Holder
T D J N R 25 25 M15





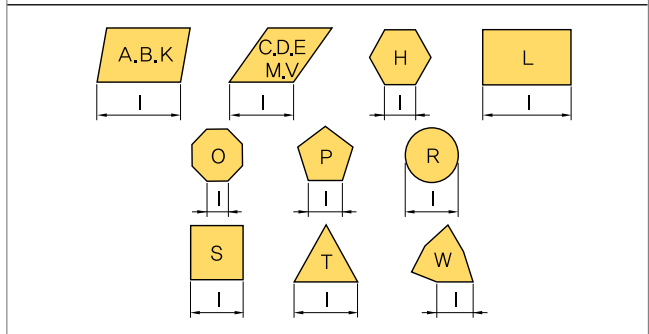



| | | |
|--------|---------|---------|
| A - 32 | H - 100 | Q - 180 |
| B - 40 | J - 110 | R - 200 |
| C - 50 | K - 125 | S - 250 |
| D - 60 | L - 140 | T - 300 |
| E - 70 | M - 150 | U - 350 |
| F - 80 | N - 160 | V - 400 |
| G - 90 | P - 170 | W - 450 |







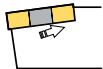
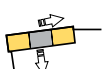
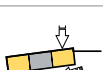

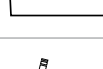
9 Elmas Kesme Uzunluđu / Length of Insert Cutting Edge
T D J N R 25 25 M15







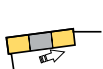
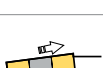
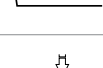
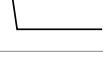









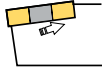
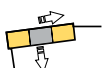
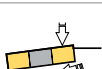

| Insert | | DNM. 1104.. ISO | DNM. 1504.. ISO | DNM. 1506.. ISO | DNM. 1504.. ISO | DNM. 1506.. ISO | DNM. 1104.. ISO | |
|-----------------|-----------------|--------------------|--------------------------------------|-------------------------------------|-------------------------------------|-------------------------------------|-------------------------------------|-------------------------------------|
| | | | | | | | | |
| Size (mm) | | #1616 - 2525 | #2020 - 3232 | #2020 - 4040 | #2525 - 3232 | #2020 - 3232 | #1616 - 2525 | |
| ISO Code | | TDJN R/L | TDJN R/L | TDJN R/L PDJN R/L | TDHN R/L | TDHN R/L | TDNNN | |
| Cutting Angle | | 93° | 93° | 93° | 107.5° | 107.5° | 62.5mm | |
| Clamping Type | T System | | ✓ Size Range (mm) #1616 - 2525 | ✓ Dia Range (mm) #2020 - 3232 | ✓ Dia Range (mm) #2020 - 4040 | ✓ Dia Range (mm) #2525 - 3232 | ✓ Dia Range (mm) #2020 - 3232 | ✓ Dia Range (mm) #1616 - 2525 |
| | Page | | A14 | A14 | A14 | A14 | A14 | A14-15 |
| | P System | | - | - | ✓ Dia Range (mm) #2020 - 4040 | - | - | - |
| | Page | | | | A21 | | | |
| | M System | | - | - | - | - | - | - |
| | Page | | | | | | | |
| | C System | | - | - | - | - | - | - |
| | Page | | | | | | | |
| S System | | - | - | - | - | - | - | |
| Page | | | | | | | | |





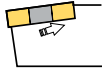
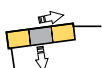
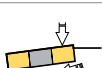

| Insert | | DNM. 1504.. ISO | DNM. 1506.. ISO | CNM. 0903.. ISO | CNM. 1204.. ISO | CNM. 1606.. ISO | CNM. 1909.. ISO | |
|-----------------|-----------------|--------------------|--------------------------------------|-------------------------------------|------------------------------|-------------------------------------|-------------------------------------|-------------------------------------|
| | | | | | | | | |
| Size (mm) | | #2020 - 3232 | #2020 - 4040 | #2525 | #2020 - 4040 | #2525 - 4040 | #3232 - 4040 | |
| ISO Code | | TDNNN | TDNNN PDNNN | TCLN R/L | TCLN R/L PCLN R/L | TCLN R/L PCLN R/L | TCLN R/L PCLN R/L | |
| Cutting Angle | | 62.5° | 62.5° | 95° | 95° | 95° | 95° | |
| Clamping Type | T System | | ✓ Size Range (mm) #1616 - 2525 | ✓ Dia Range (mm) #2020 - 4040 | ✓ Dia Range (mm) #2525 | ✓ Dia Range (mm) #2020 - 4040 | ✓ Dia Range (mm) #2525 - 4040 | ✓ Dia Range (mm) #3232 - 4040 |
| | Page | | A14-15 | A14-15 | A15 | A15 | A15 | A15 |
| | P System | | - | ✓ Dia Range (mm) #2020 - 4040 | - | ✓ Dia Range (mm) #2020 - 3232 | ✓ Dia Range (mm) #2525 - 3232 | ✓ Dia Range (mm) #3232 - 4040 |
| | Page | | | A21 | | A22 | A22 | A22 |
| | M System | | - | - | - | - | - | - |
| | Page | | | | | | | |
| | C System | | - | - | - | - | - | - |
| | Page | | | | | | | |
| S System | | - | - | - | - | - | - | |
| Page | | | | | | | | |







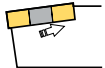
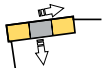
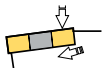
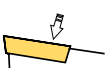
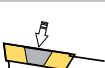

| Insert | | CNM. 1204.. ISO | CNM. 1606.. ISO | CNM. 1204.. ISO | CNM. 1606.. ISO | CNM. 1204.. ISO | CNM. 1606.. ISO | |
|-----------------|--|---|---|---|---|---|---|-------------------------------------|
| | |  |  |  |  |  |  | |
| Size (mm) | | #2020 - 2525 | #2525 - 3232 | #2020 - 2525 | #2525 - 3232 | #2020 - 3232 | #2525 - 3232 | |
| ISO Code | | TCRN R/L | TCRN R/L | TCKN R/L | TCKN R/L | TCBN R/L PCBN R/L | TCBN R/L PCBN R/L | |
| Cutting Angle | | 75° | 75° | 75° | 75° | 75° | 75° | |
| Clamping Type | T System |  | ✓ Size Range (mm) #2020 - 2525 | ✓ Dia Range (mm) #2525 - 3232 | ✓ Size Range (mm) #2020 - 2525 | ✓ Dia Range (mm) #2525 - 3232 | ✓ Size Range (mm) #2525 | ✓ Dia Range (mm) #2525 |
| | Page | | A15 | A15 | A16 | A16 | A16 | A16 |
| | P System |  | - | - | | | ✓ Dia Range (mm) #2020 - 3232 | ✓ Dia Range (mm) #2525 - 3232 |
| | Page | | | | | | A22 | A22 |
| | M System |  | - | - | - | - | - | - |
| | Page | | | | | | | |
| | C System |  | - | - | - | - | - | - |
| | Page | | | | | | | |
| S System |  | | | | | | | |
| Page | | | | | | | | |







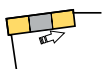
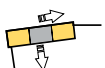
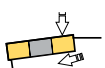

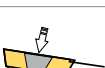
| Insert | | CNM. 1909.. ISO | CNM. 1204.. ISO | CNM. 1606.. ISO | CNM. 1909.. ISO | CNM. 1204.. ISO | CNM. 1606.. ISO | CNM. 1909.. ISO | |
|-----------------|---|---|---|---|---|---|---|---|--------------------------------------|
| | |  |  |  |  |  |  |  | |
| Size (mm) | | #3232 - 4040 | #1616 - 3232 | #2525 - 4040 | #3232 - 4040 | #2020 - 3232 | #2525 - 4040 | #3232 - 4040 | |
| ISO Code | | TCBN R/L PCBN R/L | TCMNN PCMNN | TCMNN PCMNN | TCMNN PCMNN | TCZNN | TCZNN | TCZNN | |
| Cutting Angle | | 75° | 50° | 50° | 50° | 40° | 40° | 40° | |
| Clamping Type | T System |  | ✓ Size Range (mm) #3232 | ✓ Size Range (mm) #1616 - 3232 | ✓ Size Range (mm) #2525 - 4040 | ✓ Size Range (mm) #3232 - 4040 | ✓ Size Range (mm) #2020 - 3232 | ✓ Size Range (mm) #2525 - 4040 | ✓ Size Range (mm) #3232 - 4040 |
| | Page | | A16 | A16 | A16 | A16 | A16 | A16 | |
| | P System |  | ✓ Size Range (mm) #3232 - 4040 | ✓ Size Range (mm) #2020 - 3232 | ✓ Size Range (mm) #2525 - 3232 | ✓ Size Range (mm) #3232 - 4040 | | | - |
| | Page | | A22 | A23 | A23 | A23 | | | |
| | M System |  | - | - | - | - | - | - | - |
| | Page | | | | | | | | |
| | C System |  | - | - | - | - | - | - | - |
| | Page | | | | | | | | |
| S System |  | | | | | | | - | |
| Page | | | | | | | | | |



| Insert | | SNM. 1204.. ISO | SNM. 1506.. ISO | SNM. 1906.. ISO | SNM. 1204.. ISO | SNM. 1506.. ISO | SNM. 1906.. ISO | |
|-----------------|--|---|---|---|---|---|---|--------------------------------------|
| | |  |  |  |  |  |  | |
| Size (mm) | | #2020 - 3232 | #2525 - 4040 | #3232 - 4040 | #2020 - 3232 | #2525 - 3232 | #3232 - 4040 | |
| ISO Code | | TSSN R/L PSSN R/L | TSSN R/L PSSN R/L | TSSN R/L PSSN R/L | TSKN R/L PSKN R/L | TSKN R/L PSKN R/L | PSKNR | |
| Cutting Angle | | 45° | 45° | 45° | 75° | 75° | 75° | |
| Clamping Type | T System |  | ✓ Size Range (mm) #2020 - 3232 | ✓ Size Range (mm) #2525 - 4040 | ✓ Size Range (mm) #3232 - 4040 | ✓ Size Range (mm) #2020 - 3232 | ✓ Size Range (mm) #2525 - 3232 | - |
| | Page | | A17 | A17 | A17 | A17 | A17 | |
| | P System |  | ✓ Size Range (mm) #2020 - 3232 | ✓ Size Range (mm) #2525 - 3232 | ✓ Size Range (mm) #3232 - 4040 | ✓ Size Range (mm) #2020 - 3232 | ✓ Size Range (mm) #2525 - 3232 | ✓ Size Range (mm) #3232 - 4040 |
| | Page | | A25 | A25 | A25 | A25 | A25 | A25 |
| | M System |  | - | - | - | - | - | - |
| | Page | | | | | | | |
| | C System |  | - | - | - | - | - | - |
| | Page | | | | | | | |
| S System |  | - | - | - | - | - | - | |
| Page | | | | | | | | |



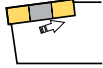
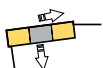
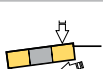



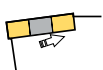
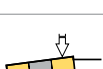

| Insert | | SNM. 1204.. ISO | SNM. 1506.. ISO | SNM. 1906.. ISO | VNM. 1604.. ISO | VNM. 1604.. ISO | VNM. 1604.. ISO | |
|-----------------|---|---|---|---|---|---|---|--------------------------------------|
| | |  |  |  |  |  |  | |
| Size (mm) | | #2020 - 3232 | #2525 - 4040 | #3232 - 4040 | #2020 - 4040 | #2020 - 3232 | #2020 - 4040 | |
| ISO Code | | TSDNN PSDNN | TSDNN PSDNN | PSDNN | TVJN R/L | TVHN R/L | TVVNN | |
| Cutting Angle | | 45° | 45° | 45° | 93° | 107.5° | 72.5° | |
| Clamping Type | T System |  | ✓ Size Range (mm) #2020 - 3232 | ✓ Size Range (mm) #2525 - 4040 | - | ✓ Size Range (mm) #2020 - 4040 | ✓ Size Range (mm) #2020 - 3232 | ✓ Size Range (mm) #2020 - 4040 |
| | Page | | A17 | A17 | | A18 | A18 | A18 |
| | P System |  | ✓ Size Range (mm) #2020 - 3232 | ✓ Size Range (mm) #2525 - 3232 | ✓ Size Range (mm) #3232 - 4040 | - | - | - |
| | Page | | A25 | A25 | 25 | | | |
| | M System |  | - | - | - | - | - | - |
| | Page | | | | | | | |
| | C System |  | - | - | - | - | - | - |
| | Page | | | | | | | |
| S System |  | - | - | - | - | - | - | |
| Page | | | | | | | | |







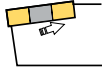
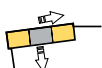
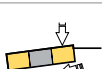

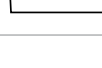
| Insert | | WNM. 0604.. ISO | WNM. 0804.. ISO | WNM. 0604.. ISO | WNM. 0804.. ISO | TNM. 1604.. ISO | TNM. 1604.. ISO | |
|-----------------|---|---|---|---|---|---|---|---------------------------------|
| | |  |  |  |  |  |  | |
| Size (mm) | | #1616 - 2525 | #2020 - 4040 | #1616 - 2525 | #2020 - 4040 | #2020 - 3232 | #2020 - 3232 | |
| ISO Code | | TWLN R/L MWLN R/L | TWLN R/L PWLN R/L MWLN R/L | MWDNN | MWDNN | TTJN R/L MTJN R/L | TTGN R/L | |
| Cutting Angle | | 95° | 95° | 50° | 50° | 93° | 90° | |
| Clamping Type | T System |  | Size Range (mm) #1616 - 2525 | Size Range (mm) #2020 - 4040 | - | - | Size Range (mm) #2020 - 3232 | Size Range (mm) #2020 - 3232 |
| | Page | | A19 | A19 | | | A20 | A20 |
| | P System |  | - | Size Range (mm) #2020 - 4040 | - | - | - | - |
| | Page | | | 24 | | | | |
| | M System |  | Size Range (mm) #1616 - 2525 | Size Range (mm) #2020 - 4040 | Size Range (mm) #1616 - 2525 | Size Range (mm) #2020 - 4040 | Size Range (mm) #2020 - 3232 | - |
| | Page | | A27 | A27 | A27 | A27 | A26 | A26 |
| | C System |  | - | - | - | - | - | - |
| | Page | | | | | | | |
| S System |  | - | - | - | - | - | - | |
| Page | | | | | | | | |







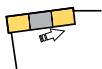
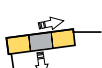
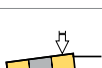

| Insert | | TNM. 1604.. ISO | TNM. 1604.. ISO | TNM. 2204.. ISO | TNM. 2204.. ISO | TNM. 2204.. ISO | TNM. 2204.. ISO | |
|-----------------|---|---|---|---|---|---|---|---------------------------------|
| | |  |  |  |  |  |  | |
| Size (mm) | | #2020 - 3232 | #2020 - 3232 | #2525 - 4040 | #2525 - 4040 | #2525 - 4040 | #2525 - 4040 | |
| ISO Code | | TTFN R/L | TTENN MTENN | TTJN R/L MTJN R/L | TTGN R/L | TTFN R/L | TTENN MTENN | |
| Cutting Angle | | 95° | 60° | 93° | 90° | 90° | 60° | |
| Clamping Type | T System |  | Size Range (mm) #2020 - 3232 | Size Range (mm) #2020 - 3232 | Size Range (mm) #2525 - 4040 | Size Range (mm) #2525 - 4040 | Size Range (mm) #2525 - 4040 | Size Range (mm) #2525 - 4040 |
| | Page | | A20 | A20 | A20 | A20 | A20 | A20 |
| | P System |  | - | - | - | - | - | - |
| | Page | | | | | | | |
| | M System |  | - | Size Range (mm) #2020 - 3232 | Size Range (mm) #2020 - 4040 | - | - | - |
| | Page | | | A26 | A26 | | | |
| | C System |  | - | - | - | - | - | Size Range (mm) #2525 - 4040 |
| | Page | | | | | | | A26 |
| S System |  | - | - | - | - | - | - | |
| Page | | | | | | | | |





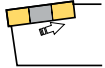
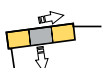
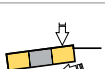

| Insert | | DN.N. 1507.. ISO | CN.N 1207.. ISO | SN.N 1207.. ISO | SN.N 1207.. ISO | SN.N 1207.. ISO | TN.N 1607.. ISO | |
|---------------|--|---|---|---|---|---|---|--------------------------------------|
| | |  |  |  |  |  |  | |
| Size (mm) | | #2525 - 3232 | #2525 - 3232 | #2525 - 3232 | #2525 - 3232 | #2525 - 3232 | #2525 - 3232 | |
| ISO Code | | CDJN R/L | CCLN R/L | CSSN R/L | CSKN R/L | CSDNN | CTJN R/L | |
| Cutting Angle | | 93° | 50° | 45° | 75° | 45° | 93° | |
| Clamping Type | T System |  | - | - | - | - | - | |
| | Page | | | | | | | |
| | P System |  | - | - | - | - | - | |
| | Page | | | | | | | |
| | M System |  | - | - | - | - | - | |
| | Page | | | | | | | |
| | C System |  | ✓ Size Range (mm) #2525 - 3232 | ✓ Size Range (mm) #2525 - 3232 | ✓ Size Range (mm) #2525 - 3232 | ✓ Size Range (mm) #2525 - 3232 | ✓ Size Range (mm) #2525 - 3232 | ✓ Size Range (mm) #2525 - 3232 |
| | Page | | A28 | A28 | A29 | A29 | A29 | A30 |
| S System |  | - | - | - | - | - | - | |
| Page | | | | | | | | |





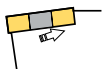
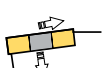
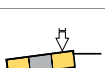

| Insert | | KNUX R/L ISO | | | | | | |
|---------------|---|---|--------------------------------------|--|--|--|--|--|
| | |  | | | | | | |
| Size (mm) | | #2020 - 4040 | | | | | | |
| ISO Code | | CKJN R/L | | | | | | |
| Cutting Angle | | 93° | | | | | | |
| Clamping Type | T System |  | - | | | | | |
| | Page | | | | | | | |
| | P System |  | - | | | | | |
| | Page | | | | | | | |
| | M System |  | - | | | | | |
| | Page | | | | | | | |
| | C System |  | ✓ Size Range (mm) #2020 - 4040 | | | | | |
| | Page | | A30 | | | | | |
| S System |  | - | | | | | | |
| Page | | | | | | | | |

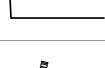



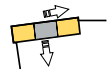
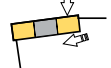
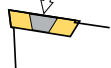
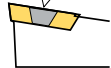

| Insert | | DCM. 0702.. ISO | DCM. 11T3.. ISO | DCM. 0702.. ISO | DCM. 11T3.. ISO | DCM. 0702.. ISO | DCM. 11T3.. ISO |
|---|--|---|---|---|---|---|---|
| | |  |  |  |  |  |  |
| Size (mm) | | #0808 - 1616 | #1212 - 3232 | #0808 - 1616 | #1616 - 3232 | #1010 - 1616 | #1212 - 1616 |
| ISO Code | | SDJC R/L | SDJC R/L | SDHC R/L | SDHC R/L | SDAC R/L | SDHC R/L |
| Cutting Angle | | 93° | 93° | 107.5° | 107.5° | 91° | 91° |
| Clamping Type | T System  | - | - | - | - | - | - |
| | Page | | | | | | |
| | P System  | - | - | - | - | - | - |
| | Page | | | | | | |
| | M System  | - | - | - | - | - | - |
| | Page | | | | | | |
| | S System  | ✓ Size Range (mm) #0808 - 1616 | ✓ Size Range (mm) #1212 - 3232 | ✓ Size Range (mm) #0808 - 1616 | ✓ Size Range (mm) #1616 - 3232 | - | - |
| | Page | A31 | A31 | A32 | A32 | | |
| S System Swiss (K.O)  | ✓ Size Range (mm) #1010 - 2020 | ✓ Size Range (mm) #1212 - 2020 | - | - | ✓ Size Range (mm) #1010 - 1616 | ✓ Size Range (mm) #1212 - 1616 | |
| Page | A41 | A41 | | | A41 | A41 | |

| Insert | | DCM. 0702.. ISO | DCM. 11T3.. ISO | VBM. 1103.. ISO | VBM. 1604.. ISO | VBM. 1103.. ISO | VBM. 1604.. ISO |
|--|--|---|---|---|---|---|---|
| | |  |  |  |  |  |  |
| Size (mm) | | #0808 - 1616 | #1212 - 3232 | #1212 - 2525 | #1616 - 3232 | #1616 - 2525 | #1616 - 3232 |
| ISO Code | | SDNCN | SDNCN | SVJB R/L | SVJB R/L | SVHB R/L | SVHB R/L |
| Cutting Angle | | 62.5° | 62.5° | 93° | 93° | 107.5° | 107.5° |
| Clamping Type | T System  | - | - | - | - | - | - |
| | Page | | | | | | |
| | P System  | - | - | - | - | - | - |
| | Page | | | | | | |
| | M System  | - | - | - | - | - | - |
| | Page | | | | | | |
| | S System  | ✓ Size Range (mm) #0808 - 1616 | ✓ Size Range (mm) #1212 - 3232 | ✓ Size Range (mm) #1212 - 2525 | ✓ Size Range (mm) #1616 - 3232 | ✓ Size Range (mm) #1616 - 2525 | ✓ Size Range (mm) #1616 - 3232 |
| | Page | A31 | A31 | A32 | A32 | A33 | A33 |
| S System Swiss (K.O)  | - | - | Size Range (mm) #1010 - 2020 | - | - | - | |
| Page | | | A43 | | | | |

| Insert | | VBM. 1103.. ISO | VBM. 1604.. ISO | VBM. 1103.. ISO | VBM. 1604.. ISO | VCM. 1103.. ISO | VCM. 1604.. ISO |
|-----------------|--|---|---|---|---|---|---|
| | |  |  |  |  |  |  |
| Size (mm) | | #1616 - 2525 | #1616 - 3232 | #1616 - 2525 | #1616 - 3232 | #1616 - 2020 | #2020 - 3232 |
| ISO Code | | SVZB R/L | SVZB R/L | SVVBN | SVVBN | SVJC R/L | SVJC R/L |
| Cutting Angle | | 100° | 100° | 72.5° | 72.5° | 93° | 93° |
| Clamping Type | T System |  | - | - | - | - | - |
| | Page | | | | | | |
| | P System |  | - | - | - | - | - |
| | Page | | | | | | |
| | M System |  | - | - | - | - | - |
| | Page | | | | | | |
| | C System |  | - | - | - | - | - |
| | Page | | | | | | |
| S System |  | ✓ Size Range (mm) #1616 - 2525 | ✓ Size Range (mm) #1616 - 3232 | ✓ Size Range (mm) #1616 - 2525 | ✓ Size Range (mm) #1616 - 3232 | ✓ Size Range (mm) #1616 - 2020 | ✓ Size Range (mm) #2020 - 3232 |
| Page | | A33 | A33 | A33 | A33 | A34 | A34 |





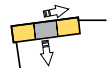
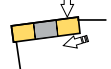
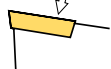
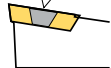



| Insert | | VCM. 1103.. ISO | VCM. 1604.. ISO | VCM. 1103.. ISO | VCM. 1604.. ISO | VCM. 1103.. ISO | VCM. 1604.. ISO | |
|-----------------------------|---|---|---|---|---|---|---|--------------------------------------|
| | |  |  |  |  |  |  | |
| Size (mm) | | #1616 - 2020 | #2020 - 3232 | #1616 - 2020 | #2020 - 3232 | #1616 - 2020 | #2020 - 3232 | |
| ISO Code | | SVHC R/L | SVHC R/L | SVVCN | SVVCN | SVAC R/L | SVAC R/L | |
| Cutting Angle | | 107.5° | 107.5° | 72.5° | 72.5° | 90° | 90° | |
| Clamping Type | T System |  | - | - | - | - | - | |
| | Page | | | | | | | |
| | P System |  | - | - | - | - | - | |
| | Page | | | | | | | |
| | M System |  | - | - | - | - | - | |
| | Page | | | | | | | |
| | S System |  | ✓ Size Range (mm) #1616 - 2020 | ✓ Size Range (mm) #2020 - 3232 | ✓ Size Range (mm) #1616 - 2020 | ✓ Size Range (mm) #2020 - 3232 | ✓ Size Range (mm) #1616 - 2020 | ✓ Size Range (mm) #2020 - 3232 |
| | Page | | A34 | A34 | A34 | A34 | | |
| S System Swiss (K.O) |  | - | - | - | - | ✓ Size Range (mm) #1616 - 2020 | ✓ Size Range (mm) #1616 - 2020 | |
| Page | | | | | | A43 | A43 | |







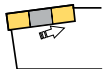
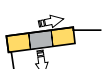
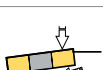

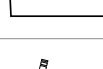
| Insert | | CCM.0602.. ISO | CCM.09T3.. ISO | CCM.1204.. ISO | CCM.0602.. ISO | CCM.09T3.. ISO | CCM.1204.. ISO | |
|-----------------------------|---|---|---|---|---|---|---|--------------------------------------|
| | |  |  |  |  |  |  | |
| Size (mm) | | #0808 - 1212 | #1212 - 2525 | #1616 - 2525 | #0808 - 1010 | #1212 - 2525 | #2020 - 2525 | |
| ISO Code | | SCLC R/L | SCLC R/L | SCLC R/L | SCAC R/L | SCAC R/L | SCAC R/L | |
| Cutting Angle | | 95° | 95° | 95° | 90° | 90° | 90° | |
| Clamping Type | T System |  | - | - | - | - | - | |
| | Page | | | | | | | |
| | P System |  | - | - | - | - | - | |
| | Page | | | | | | | |
| | M System |  | - | - | - | - | - | |
| | Page | | | | | | | |
| | S System |  | ✓ Size Range (mm) #0808 - 1212 | ✓ Size Range (mm) #1212 - 2525 | ✓ Size Range (mm) #1616 - 2525 | ✓ Size Range (mm) #0808 - 1010 | ✓ Size Range (mm) #1212 - 2525 | ✓ Size Range (mm) #2020 - 2525 |
| | Page | | A35 | A35 | A35 | A36 | A36 | A36 |
| S System Swiss (K.O) |  | ✓ Size Range (mm) #1010 - 1616 | ✓ Size Range (mm) #1212 - 2020 | - | ✓ Size Range (mm) #1010 - 1616 | ✓ Size Range (mm) #1212 - 1616 | - | |
| Page | | A42 | A42 | | A42 | A42 | | |





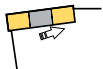
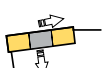
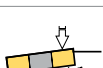

| Insert | | CCM.0602.. ISO | CCM.09T3.. ISO | CCM.1204.. ISO | SCM.09T3.. ISO | SCM.1204.. ISO | SCM.09T3.. ISO |
|-----------------|---|---|---|---|---|---|---|
| | |  |  |  |  |  |  |
| Size (mm) | | #0808 - 1010 | #1212 - 2525 | #2020 - 2525 | #1212 - 2525 | #1616 - 2525 | #1212 - 2525 |
| ISO Code | | SCMCN | SCMCN | SCMCN | SSSC R/L | SSSC R/L | SSDCN |
| Cutting Angle | | 50° | 50° | 50° | 45° | 45° | 45° |
| Clamping Type | T System |  | - | - | - | - | - |
| | Page | | | | | | |
| | P System |  | - | - | - | - | - |
| | Page | | | | | | |
| | M System |  | - | - | - | - | - |
| | Page | | | | | | |
| | C System |  | - | - | - | - | - |
| | Page | | | | | | |
| S System |  | ✓ Size Range (mm) #0808 - 1010 | ✓ Size Range (mm) #1212 - 2525 | ✓ Size Range (mm) #2020 - 2525 | ✓ Size Range (mm) #1212 - 2525 | ✓ Size Range (mm) #1616 - 2525 | ✓ Size Range (mm) #1212 - 2525 |
| Page | | A36 | A36 | A36 | A37 | A37 | A37 |

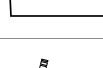
| Insert | | SCM. 1204.. ISO | TCM. 0902.. ISO | TCM. 1102.. ISO | TCM. 16T3.. ISO | TCM. 0902.. ISO | TCM. 1102.. ISO | |
|-----------------------------|-----------------|--------------------|--------------------------------------|--------------------------------------|--------------------------------------|--------------------------------------|--------------------------------------|--------------------------------------|
| | | | | | | | | |
| Size (mm) | | #1616 - 2525 | #0808 - 1010 | #1212 - 1616 | #1616 - 3232 | #0808 - 1010 | #1212 - 1616 | |
| ISO Code | | SSDCN | STJC R/L | STJC R/L | STJC R/L | STGC R/L | STGC R/L | |
| Cutting Angle | | 45° | 93° | 93° | 93° | 90° | 90° | |
| Clamping Type | T System | | - | - | - | - | - | |
| | Page | | | | | | | |
| | P System | | - | - | - | - | - | |
| | Page | | | | | | | |
| | M System | | - | - | - | - | - | |
| | Page | | | | | | | |
| | S System | | ✓ Size Range (mm) #1616 - 2525 | ✓ Size Range (mm) #0808 - 1010 | ✓ Size Range (mm) #1212 - 1616 | ✓ Size Range (mm) #1616 - 3232 | ✓ Size Range (mm) #0808 - 1010 | ✓ Size Range (mm) #1212 - 1616 |
| | Page | | A37 | A38 | A38 | A38 | A38 | |
| S System Swiss (K.O) | | - | - | - | - | - | ✓ Size Range (mm) #1212 - 1616 | |
| Page | | | | | | | A43 | |

| Insert | | TCM. 16T3.. ISO | TCM. 0902.. ISO | TCM. 1102.. ISO | TCM. 16T3.. ISO | TCM. 1102.. ISO | TCM. 16T3.. ISO | |
|-----------------------------|-----------------|--------------------------------------|--------------------------------------|--------------------------------------|--------------------------------------|--------------------------------------|-------------------------------|--------------------------------------|
| | | | | | | | | |
| Size (mm) | | #1616 - 3232 | #0808 - 1010 | #1212 - 1616 | #1616 - 3232 | #2020 | #2020 - 3232 | |
| ISO Code | | STGC R/L | STFC R/L | STFC R/L | STFC R/L | STNCN | STNCN | |
| Cutting Angle | | 90° | 90° | 90° | 90° | 90° | 90° | |
| Clamping Type | T System | | - | - | - | - | - | |
| | Page | | | | | | | |
| | P System | | - | - | - | - | - | |
| | Page | | | | | | | |
| | M System | | - | - | - | - | - | |
| | Page | | | | | | | |
| | S System | | ✓ Size Range (mm) #1616 - 3232 | ✓ Size Range (mm) #0808 - 1010 | ✓ Size Range (mm) #1212 - 1616 | ✓ Size Range (mm) #1616 - 3232 | ✓ Size Range (mm) #2020 | ✓ Size Range (mm) #2020 - 3232 |
| | Page | | A38 | A38 | A38 | A38 | A38 | |
| S System Swiss (K.O) | | ✓ Size Range (mm) #1616 - 2020 | | | | | | |
| Page | | A43 | | | | | | |

| Insert | | RC.T 0602.. ISO | RC.T 0803.. ISO | RC.T 10T3.. ISO | RC.T 1204.. ISO | RC.T 1605.. ISO | RC.T 2006.. ISO |
|---------------|--|---|---|---|---|---|---|
| | |  |  |  |  |  |  |
| Size (mm) | | #1616 - 2525 | #1616 - 3232 | #1616 - 3232 | #2020 - 3232 | #2525 - 3232 | #2525 - 3232 |
| ISO Code | | SRGC R/L | SRGC R/L | SRGC R/L | SRGC R/L | SRGC R/L | SRGC R/L |
| Cutting Angle | | -° | -° | -° | -° | -° | -° |
| Clamping Type | T System |  | - | - | - | - | - |
| | Page | | | | | | |
| | P System |  | - | - | - | - | - |
| | Page | | | | | | |
| | M System |  | - | - | - | - | - |
| | Page | | | | | | |
| | C System |  | - | - | - | - | - |
| | Page | | | | | | |
| S System |  | ✓ Size Range (mm) #1616 - 2525 | ✓ Size Range (mm) #1616 - 3232 | ✓ Size Range (mm) #1616 - 3232 | ✓ Size Range (mm) #2020 - 3232 | ✓ Size Range (mm) #2525 - 3232 | ✓ Size Range (mm) #2525 - 3232 |
| Page | | A39 | A39 | A39 | A39 | A39 | A39 |

| Insert | | RC.T 10T3.. ISO | RC.T 1204.. ISO | RC.T 1605.. ISO | RC.T 0803.. ISO | RC.T 10T3.. ISO | RC.T 1204.. ISO |
|---------------|---|---|---|---|---|---|---|
| | |  |  |  |  |  |  |
| Size (mm) | | #2020 - 2525 | #2020 - 2525 | #2020 - 2525 | #2525 | #2525 | #2525 |
| ISO Code | | SRHC R/L | SRGC R/L | SRHC R/L | SRXC R/L | SRXC R/L | SRXC R/L |
| Cutting Angle | | -° | -° | -° | -° | -° | -° |
| Clamping Type | T System |  | - | - | - | - | - |
| | Page | | | | | | |
| | P System |  | - | - | - | - | - |
| | Page | | | | | | |
| | M System |  | - | - | - | - | - |
| | Page | | | | | | |
| | C System |  | - | - | - | - | - |
| | Page | | | | | | |
| S System |  | ✓ Size Range (mm) #2020 - 2525 | ✓ Size Range (mm) #2020 - 2525 | ✓ Size Range (mm) #2020 - 2525 | ✓ Size Range (mm) #2525 | ✓ Size Range (mm) #2525 | ✓ Size Range (mm) #2525 |
| Page | | A39 | A39 | A39 | A40 | A40 | A40 |

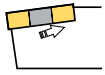
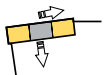
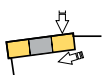
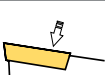
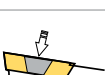
| Insert | | RC.T 0602.. ISO | RC.T 0803.. ISO | RC.T 10T3.. ISO | RC.T 1204.. ISO | RC.T 1605.. ISO | RC.T 2006.. ISO |
|-----------------|---|---|---|---|---|---|---|
| | |  |  |  |  |  |  |
| Size (mm) | | #1616 - 2525 | #1616 - 3232 | #1616 - 3232 | #2020 - 3232 | #2525 - 3232 | #2525 - 4040 |
| ISO Code | | SRDCN | SRDCN | SRDCN | SRDCN | SRDCN | SRDCN |
| Cutting Angle | | -° | -° | -° | -° | -° | -° |
| Clamping Type | T System |  | - | - | - | - | - |
| | Page | | | | | | |
| | P System |  | - | - | - | - | - |
| | Page | | | | | | |
| | M System |  | - | - | - | - | - |
| | Page | | | | | | |
| | C System |  | - | - | - | - | - |
| | Page | | | | | | |
| S System |  | ✓ Size Range (mm) #1616 - 2525 | ✓ Size Range (mm) #1616 - 3232 | ✓ Size Range (mm) #1616 - 3232 | ✓ Size Range (mm) #2020 - 3232 | ✓ Size Range (mm) #2525 - 3232 | ✓ Size Range (mm) #2525 - 4040 |
| Page | | A40 | A40 | A40 | A40 | A40 | A40 |



| Ordering Code | | Item Designation | Price | Master Insert* |
|------------------|-------------|-------------------------|-------------|----------------|
| <i>Direction</i> | | TDJN R/L-JT (93) | EURO | |
| <i>Right</i> | <i>Left</i> | | | |
| SM56022 | SM56039 | TDJN R/L 2525 M15-JT | 103 € | DNM.1506.. |
| | | | | |

Cooling accessories are optional / See Page 297 for cooling accessory.
Soğutma ekipmanları opsiyoneldir / Bkz. Sayfa 297 Soğutma aksesuarları için



| Ordering Code | | Item Designation | Price | Master Insert* |
|------------------|-------------|----------------------|-------------|----------------|
| <i>Direction</i> | | TDJN R/L (93) | EURO | |
| <i>Right</i> | <i>Left</i> | | | |
| SM26766 | SM00407 | TDJN R/L 1616 H11 | 50 € | DNM.1104.. |
| SM00353 | SM00360 | TDJN R/L 2020 K11 | 56 € | |
| SM00346 | SM00377 | TDJN R/L 2525 M11 | 59 € | DNM.1504.. |
| SM29675 | SM34006 | TDJN R/L 2020 K1504 | 56 € | |
| SM29682 | SM33993 | TDJN R/L 2525 M1504 | 59 € | DNM.1506.. |
| SM33948 | SM33986 | TDJN R/L 3232 P1504 | 69 € | |
| SM00421 | SM00469 | TDJN R/L 2020 K15 | 56 € | DNM.1506.. |
| SM00438 | SM00483 | TDJN R/L 2525 M15 | 59 € | |
| SM00506 | SM00490 | TDJN R/L 3232 P15 | 69 € | |
| SM00520 | SM00513 | TDJN R/L 4040 S15 | 108 € | |



| Ordering Code | | Item Designation | Price | Master Insert* |
|------------------|-------------|-------------------------|-------------|----------------|
| <i>Direction</i> | | TDHN R/L (107.5) | EURO | |
| <i>Right</i> | <i>Left</i> | | | |
| SM34044 | SM34075 | TDHN R/L 2525 M1504 | 59 € | DNM.1504.. |
| SM34051 | SM34068 | TDHN R/L 3232 P1504 | 69 € | |
| SM38783 | SM38776 | TDHN R/L 2020 K15 | 56 € | DNM.1506.. |
| SM26544 | SM26926 | TDHN R/L 2525 M15 | 59 € | |
| SM26919 | SM26933 | TDHN R/L 3232 P15 | 69 € | |



| Ordering Code | | Item Designation | Price | Master Insert* |
|------------------|--|------------------------|-------------|----------------|
| <i>Direction</i> | | TDNNN-JT (62.5) | EURO | |
| <i>Neutral</i> | | | | |
| SM56091 | | TDNNN 2525 M15-JT | 103 € | DNM.1506.. |
| | | | | |

Cooling accessories are optional / See Page 297 for cooling accessory.
Soğutma ekipmanları opsiyoneldir / Bkz. Sayfa 297 Soğutma aksesuarları için

| Size Designation | Master Insert* | Spare Parts | | | | | |
|------------------|----------------|--------------|-----------------------|---------------------|-----------------------|-----------------------|------------------|
| | | Clamp | Screw | Shim | Shim Screw | Stamp | Allen Key |
| 1616 - 2525 | DNM.1104.. | | | | | | |
| | | TSK2 9102 | TSBV M5x24-9202 | BAX DN11-9601 | TSAV M4x10x6-9402 | - | |
| 2020 - 3232 | DNM.1504.. | | | | | | |
| | | TSK1 9101 | TSBV M6x30 9205 | BAX DN15 9602 | TSAV M4x10 9403 | TSP 6.5X12 9705 | SAK- AA3-9902 |
| 2020 - 4040 | DNM.1506.. | | | | | | |



| Ordering Code | | Item Designation | Price | Master Insert* |
|------------------|--|---------------------|-------------|---|
| <i>Direction</i> | | TDNNN (62.5) | EURO |  |
| <i>Neutral</i> | | | | |
| SM00414 | | TDNNN 1616 H11 | 50 € | DNM.1104.. |
| SM00384 | | TDNNN 2020 K11 | 56 € | |
| SM00391 | | TDNNN 2525 M11 | 59 € | DNM.1504.. |
| SM34013 | | TDNNN 2020 K1504 | 56 € | |
| SM34020 | | TDNNN 2525 M1504 | 59 € | DNM.1506.. |
| SM34037 | | TDNNN 3232 P1504 | 69 € | |
| SM00452 | | TDNNN 2020 K15 | 56 € | DNM.1506.. |
| SM00476 | | TDNNN 2525 M15 | 59 € | |
| SM00445 | | TDNNN 3232 P15 | 69 € | |
| SM00537 | | TDNNN 4040 S15 | 108 € | |



| Ordering Code | | Item Designation | Price | Master Insert* |
|------------------|-------------|-------------------------|-------------|---|
| <i>Direction</i> | | TCLN R/L-JT (95) | EURO |  |
| <i>Right</i> | <i>Left</i> | | | |
| SM56060 | SM56077 | TCLN R/L 2525 M12-JT | 103 € | CNM.1204.. |
| | | | | |

Cooling accessories are optional / See Page 297 for cooling accessory.
Soğutma ekipmanları opsiyoneldir / Bkz. Sayfa 297 Soğutma aksesuarları için



| Ordering Code | | Item Designation | Price | Master Insert* |
|------------------|-------------|----------------------|-------------|---|
| <i>Direction</i> | | TCLN R/L (95) | EURO |  |
| <i>Right</i> | <i>Left</i> | | | |
| SM00210 | SM55377 | TCLN R/L 2525 M09 | 59 € | CNM.0903.. |
| SM00025 | SM00032 | TCLN R/L 2020 K12 | 56 € | CNM.1204.. |
| SM00056 | SM00063 | TCLN R/L 2525 M12 | 59 € | |
| SM00087 | SM00094 | TCLN R/L 3232 P12 | 69 € | CNM.1606.. |
| SM27091 | SM27107 | TCLN R/L 4040 S12 | 111 € | |
| SM00148 | SM00155 | TCLN R/L 2525 M16 | 69 € | CNM.1909.. |
| SM00179 | SM00186 | TCLN R/L 3232 P16 | 77 € | |
| SM00209 | SM00193 | TCLN R/L 4040 S16 | 117 € | CNM.1909.. |
| SM00261 | SM00278 | TCLN R/L 3232 P19 | 91 € | |
| SM00285 | SM00292 | TCLN R/L 4040 S19 | 121 € | |



| Ordering Code | | Item Designation | Price | Master Insert* |
|------------------|-------------|----------------------|-------------|---|
| <i>Direction</i> | | TCRN R/L (75) | EURO |  |
| <i>Right</i> | <i>Left</i> | | | |
| SM00388 | SM00395 | TCRN R/L 2020 K12 | 56 € | CNM.1204.. |
| SM00401 | SM00418 | TCRN R/L 2525 M12 | 59 € | |
| SM00432 | SM00449 | TCRN R/L 2525 M16 | 69 € | CNM.1606.. |
| SM00456 | SM00463 | TCRN R/L 3232 P16 | 77 € | |

*Suitable Insert is ISO

**Spare Parts Ordering Codes

T System External Lathe Tool Holders



| Ordering Code | | Item Designation | Price | Master Insert* |
|------------------|-------------|----------------------|-------------|---|
| <i>Direction</i> | | TCBN R/L (75) | EURO |  |
| <i>Right</i> | <i>Left</i> | | | |
| SM34082 | SM34099 | TCBN R/L 2525 M12 | 59 € | CNM.1204.. |
| SM34112 | SM34105 | TCBN R/L 2525 M16 | 69 € | CNM.1606.. |
| SM49055 | SM49062 | TCBN R/L 3232 P19 | 91 € | CNM.1909.. |







| Ordering Code | | Item Designation | Price | Master Insert* |
|------------------|-------------|----------------------|-------------|---|
| <i>Direction</i> | | TCKN R/L (75) | EURO |  |
| <i>Right</i> | <i>Left</i> | | | |
| SM44609 | SM44616 | TCKN R/L 2020 K12 | 56 € | CNM.1204.. |
| SM44623 | SM44630 | TCKN R/L 2525 M12 | 59 € | CNM.1606.. |
| SM44647 | SM44654 | TCKN R/L 2525 M16 | 69 € | |
| SM44661 | SM44678 | TCKN R/L 3232 P16 | 77 € | |



| Ordering Code | | Item Designation | Price | Master Insert* |
|------------------|--|-------------------|-------------|---|
| <i>Direction</i> | | TCMNN (50) | EURO |  |
| <i>Neutral</i> | | | | |
| SM00131 | | TCMNN 1616 H12 | 50 € | CNM.1204.. |
| SM00117 | | TCMNN 2020 K12 | 54 € | |
| SM00124 | | TCMNN 2525 M12 | 59 € | |
| SM00018 | | TCMNN 3232 P12 | 69 € | CNM.1606.. |
| SM00230 | | TCMNN 2525 M16 | 69 € | |
| SM00247 | | TCMNN 3232 P16 | 77 € | |
| SM00216 | | TCMNN 4040 S16 | 117 € | CNM.1909.. |
| SM00339 | | TCMNN 3232 P19 | 91 € | |
| SM00308 | | TCMNN 4040 S19 | 121 € | |



| Ordering Code | | Item Designation | Price | Master Insert* |
|------------------|--|-------------------|-------------|---|
| <i>Direction</i> | | TCZNN (40) | EURO |  |
| <i>Neutral</i> | | | | |
| SM00049 | | TCZNN 2020 K12 | 56 € | CNM.1204.. |
| SM00070 | | TCZNN 2525 M12 | 59 € | |
| SM00100 | | TCZNN 3232 P12 | 69 € | |
| SM00162 | | TCZNN 2525 M16 | 69 € | CNM.1606.. |
| SM00254 | | TCZNN 3232 P16 | 77 € | |
| SM00223 | | TCZNN 4040 S16 | 117 € | |
| SM00322 | | TCZNN 3232 P19 | 91 € | CNM.1909.. |
| SM00315 | | TCZNN 4040 S19 | 121 € | |

| Size Designation | Master Insert* | Spare Parts | | | | | |
|------------------|----------------|---|---|--|---|-----------------|--------------|
| | | Clamp | Screw | Shim | Shim Screw | Stamp | Allen Key |
| 2525 | CNM.0903.. |  |  |  |  | - | SAK-AA3-9902 |
| 2020 - 4040 | CNM.1204.. | TSK2-9102 | TSBV M5x24-9202 | BAX CC09-9616 | TSAV M4x10x6-9402 | TSP 6.5x12-9705 | |
| 2525 - 4040 | CNM.1606.. | TSK1-9101 | TSBV M6x30-9205 | BAX CN12-9603 | TSAV M4x10-9403 | - | SAK-AA4-9903 |
| 3232 - 4040 | CNM.1909.. | TSK3-9103 | TSBV M6x30x7-9206 | BAX CN16-9604 | TSAV M6x16x9-9404 | - | |
| | | TSK4-9104 | TSBV M8x30-9207 | BAX CN19-9605 | TSAV M6x16x11-9406 | - | |











| Ordering Code | | Item Designation | Price | Master Insert* |
|------------------|-------------|----------------------|-------------|---|
| <i>Direction</i> | | TSSN R/L (45) | <i>EURO</i> |  |
| <i>Right</i> | <i>Left</i> | | | |
| SM00544 | SM00551 | TSSN R/L 2020 K12 | 56 € | SNM.1204.. |
| SM00575 | SM00582 | TSSN R/L 2525 M12 | 59 € | |
| SM00605 | SM00612 | TSSN R/L 3232 P12 | 69 € | SNM.1506.. |
| SM00735 | SM00759 | TSSN R/L 2525 M15 | 69 € | |
| SM00766 | SM00797 | TSSN R/L 3232 P15 | 77 € | SNM.1906.. |
| SM00704 | SM00711 | TSSN R/L 4040 S15 | 117 € | |
| SM49079 | SM49086 | TSSN R/L 3232 P19 | 91 € | SNM.1906.. |
| SM49093 | SM49109 | TSSN R/L 4040 S19 | 121 € | |



| Ordering Code | | Item Designation | Price | Master Insert* |
|------------------|-------------|----------------------|-------------|---|
| <i>Direction</i> | | TSKN R/L (75) | <i>EURO</i> |  |
| <i>Right</i> | <i>Left</i> | | | |
| SM00636 | SM00643 | TSKN R/L 2020 K12 | 56 € | SNM.1204.. |
| SM00650 | SM00667 | TSKN R/L 2525 M12 | 59 € | |
| SM00674 | SM00681 | TSKN R/L 3232 P12 | 69 € | SNM.1506.. |
| SM00803 | SM00810 | TSKN R/L 2525 M15 | 69 € | |
| SM00780 | SM00698 | TSKN R/L 3232 P15 | 77 € | |



| Ordering Code | | Item Designation | Price | Master Insert* |
|------------------|--|-------------------|-------------|---|
| <i>Direction</i> | | TSDNN (45) | <i>EURO</i> |  |
| <i>Neutral</i> | | | | |
| SM00568 | | TSDNN 2020 K12 | 56 € | SNM.1204.. |
| SM00599 | | TSDNN 2525 M12 | 59 € | |
| SM00629 | | TSDNN 3232 P12 | 69 € | SNM.1506.. |
| SM00742 | | TSDNN 2525 M15 | 69 € | |
| SM00773 | | TSDNN 3232 P15 | 77 € | SNM.1506.. |
| SM00728 | | TSDNN 4040 S15 | 117 € | |

| Size Designation | Master Insert* | Spare Parts | | | | | |
|------------------|---|---|---|---|---|---|---|
| | | Clamp | Screw | Shim | Shim Screw | Stamp | Allen Key |
| 2020 - 3232 |  |  |  |  |  |  |  |
| 2020 - 3232 | SNM.1204.. | TSK1-9101 | TSBV M6x30-9205 | BAX SN12-9608 | TSAV M4x10-9403 | TSP 6.5x12-9705 | SAK- AA3-9902 |
| 2525 - 4040 | SNM.1506.. | TSK3-9103 | TSBV M6x30x7-9206 | BAX SN15-9609 | TSAV M6x16x9-9404 | - | SAK- AA4-9903 |
| 3232 - 4040 | SNM.1906.. | TSK4-9104 | TSBV M8x30-9207 | BAX SN19-9629 | TSAV M6x16x11-9406 | - | SAK- AA4-9903 |

*Suitable Insert is ISO

**Spare Parts Ordering Codes



| Ordering Code | | Item Designation | Price | Master Insert* |
|------------------|-------------|----------------------|-------------|----------------|
| <i>Direction</i> | | TVJN R/L (93) | <i>EURO</i> | |
| <i>Right</i> | <i>Left</i> | | | |
| SM01015 | SM01084 | TVJN R/L 2020 K16 | 56 € | VNM.1604.. |
| SM01039 | SM01046 | TVJN R/L 2525 M16 | 59 € | |
| SM01060 | SM01077 | TVJN R/L 3232 P16 | 69 € | |
| SM32514 | SM32521 | TVJN R/L 4040 S16 | 108 € | |



| Ordering Code | | Item Designation | Price | Master Insert* |
|------------------|-------------|-------------------------|-------------|----------------|
| <i>Direction</i> | | TVHN R/L (107.5) | <i>EURO</i> | |
| <i>Right</i> | <i>Left</i> | | | |
| SM23796 | SM23802 | TVHN R/L 2020 K16 | 56 € | VNM.1604.. |
| SM23819 | SM23826 | TVHN R/L 2525 M16 | 59 € | |
| SM27114 | SM27121 | TVHN R/L 3232 P16 | 69 € | |



| Ordering Code | | Item Designation | Price | Master Insert* |
|------------------|--|---------------------|-------------|----------------|
| <i>Direction</i> | | TVVNN (72.5) | <i>EURO</i> | |
| <i>Neutral</i> | | | | |
| SM01022 | | TVVNN 2020 K16 | 56 € | VNM.1604.. |
| SM01053 | | TVVNN 2525 M16 | 59 € | |
| SM01091 | | TVVNN 3232 P16 | 69 € | |
| SM32538 | | TVVNN 4040 S16 | 108 € | |

| Size Designation | Master Insert* | Spare Parts | | | | | |
|------------------|----------------|--------------|--------------------|------------------|-------------------------|--------------------|------------------|
| | | <i>Clamp</i> | <i>Screw</i> | <i>Shim</i> | <i>Shim Screw</i> | <i>Stamp</i> | <i>Allen Key</i> |
| 2020 | | | | | | | |
| 2525 - 4040 | VNM.1604.. | TSK5-9105 | TSBV M6x30-9205 | BAX VN16-9612 | TSAV M4x10x6 9402 | TSP 6.5x12-9705 | SAK- AA3-9902 |









| Ordering Code | | Item Designation | Price | Master Insert* |
|------------------|-------------|-------------------------|-------------|---|
| <i>Direction</i> | | <i>TWLN R/L-JT (95)</i> | <i>EURO</i> |  |
| <i>Right</i> | <i>Left</i> | | | |
| SM56046 | SM56053 | TWLN R/L 2525 M08-JT | 103 € | WNM.0804.. |

Cooling accessories are optional / See Page 297 for cooling accessory.
Soğutma ekipmanları opsiyoneldir / Bkz. Sayfa 297 Soğutma aksesuarları için



| Ordering Code | | Item Designation | Price | Master Insert* |
|------------------|-------------|----------------------|-------------|---|
| <i>Direction</i> | | <i>TWLN R/L (95)</i> | <i>EURO</i> |  |
| <i>Right</i> | <i>Left</i> | | | |
| SM01107 | SM01114 | TWLN R/L 1616 H06 | 50 € | WNM.0604.. |
| SM01121 | SM01138 | TWLN R/L 2020 K06 | 56 € | |
| SM01145 | SM01152 | TWLN R/L 2525 M06 | 59 € | |
| SM01176 | SM01169 | TWLN R/L 2020 K08 | 56 € | WNM.0804.. |
| SM01206 | SM01183 | TWLN R/L 2525 M08 | 59 € | |
| SM01213 | SM01190 | TWLN R/L 3232 P08 | 69 € | |
| SM01220 | SM01237 | TWLN R/L 4040 S08 | 108 € | |

| Size Designation | Master Insert* | Spare Parts | | | | | |
|------------------|---|--|---|---|--|--|---|
| | | Clamp | Screw | Shim | Shim Screw | Stamp | Allen Key |
| 1616 - 2525 |  WNM.0604.. |  TSK2-9102 |  TSBV M5x24-9202 |  BAX WN06-9606 |  CSAV M3x8-9401 |  - |  SAK- AA3-9902 |
| 2020 - 4040 | WNM.0804.. | TSK1-9101 | TSBV M6x30-9205 | BAX WN08-9607 | TSAV M4x10-9403 | TSP 6.5x12-9705 | |

T System External Lathe Tool Holders



| Ordering Code | | Item Designation | Price | Master Insert* |
|------------------|-------------|---------------------|-------------|----------------|
| <i>Direction</i> | | TTJN R/L(93) | EURO | |
| <i>Right</i> | <i>Left</i> | | | |
| SM00827 | SM00834 | TTJN R/L 2020 K16 | 56 € | TNM.1604.. |
| SM00858 | SM00865 | TTJN R/L 2525 M16 | 59 € | |
| SM00889 | SM00896 | TTJN R/L 3232 P16 | 69 € | |
| SM00919 | SM00926 | TTJN R/L 2525 M22 | 66 € | TNM.2204.. |
| SM00940 | SM00957 | TTJN R/L 3232 P22 | 72 € | |
| SM00971 | SM00988 | TTJN R/L 4040 S22 | 121 € | |



| Ordering Code | | Item Designation | Price | Master Insert* |
|------------------|-------------|----------------------|-------------|----------------|
| <i>Direction</i> | | TTGN R/L (90) | EURO | |
| <i>Right</i> | <i>Left</i> | | | |
| SM44449 | SM44456 | TTGN R/L 2020 K16 | 56 € | TNM.1604.. |
| SM44463 | SM44470 | TTGN R/L 2525 M16 | 59 € | |
| SM49116 | SM49123 | TTGN R/L 3232 P16 | 69 € | |
| SM44487 | SM44494 | TTGN R/L 2525 M22 | 66 € | TNM.2204.. |
| SM44500 | SM44517 | TTGN R/L 3232 P22 | 72 € | |
| SM49130 | SM51409 | TTGN R/L 4040 S22 | 121 € | |



| Ordering Code | | Item Designation | Price | Master Insert* |
|------------------|-------------|----------------------|-------------|----------------|
| <i>Direction</i> | | TTFN R/L (90) | EURO | |
| <i>Right</i> | <i>Left</i> | | | |
| SM44524 | SM44531 | TTFN R/L 2020 K16 | 56 € | TNM.1604.. |
| SM44548 | SM44555 | TTFN R/L 2525 M16 | 59 € | |
| SM49154 | SM49161 | TTFN R/L 3232 P16 | 69 € | |
| SM44562 | SM44579 | TTFN R/L 2525 M22 | 66 € | TNM.2204.. |
| SM44586 | SM44593 | TTFN R/L 3232 P22 | 72 € | |
| SM49178 | SM49185 | TTFN R/L 4040 S22 | 121 € | |



| Ordering Code | | Item Designation | Price | Master Insert* |
|------------------|--|-------------------|-------------|----------------|
| <i>Direction</i> | | TTENN (60) | EURO | |
| <i>Neutral</i> | | | | |
| SM00841 | | TTENN 2020 K16 | 56 € | TNM.1604.. |
| SM00872 | | TTENN 2525 M16 | 59 € | |
| SM00902 | | TTENN 3232 P16 | 69 € | |
| SM00933 | | TTENN 2525 M22 | 66 € | TNM.2204.. |
| SM00964 | | TTENN 3232 P22 | 72 € | |
| SM00995 | | TTENN 4040 S22 | 121 € | |

| Size Designation | Master Insert* | Spare Parts | | | | | |
|------------------|----------------|-------------|-----------------|---------------|-------------------|-----------------|--------------|
| | | Clamp | Screw | Shim | Shim Screw | Stamp | Allen Key |
| 2020 - 3232 | TNM.1604.. | TSK2-9102 | TSBV M5x24-9202 | BAX TN16-9610 | TSAV M4x10x7-9413 | - | SAK-AA3-9902 |
| 2525 - 4040 | TNM.2204.. | TSK1-9101 | TSBV M6x30-9205 | BAX TN22-9611 | TSAV M4x10-9403 | TSP 6.5x12-9705 | |

EXTERNAL TURNING TOOLS



| Ordering Code | | Item Designation | Price | Master Insert* |
|------------------|-------------|-------------------------|-------------|---|
| <i>Direction</i> | | PDJN R/L-JT (93) | EURO |  |
| <i>Right</i> | <i>Left</i> | | | |
| SM50747 | SM50754 | PDJN R/L 2525 M15-JT | 103 € | DNM.1506.. |

Cooling accessories are optional / See Page 297 for cooling accessory.
Soğutma ekipmanları opsiyoneldir / Bkz. Sayfa 297 Soğutma aksesuarları için



| Ordering Code | | Item Designation | Price | Master Insert* |
|------------------|-------------|----------------------|-------------|---|
| <i>Direction</i> | | PDJN R/L (93) | EURO |  |
| <i>Right</i> | <i>Left</i> | | | |
| SM01794 | SM01800 | PDJN R/L 2020 K15 | 56 € | DNM.1506.. |
| SM01817 | SM01824 | PDJN R/L 2525 M15 | 59 € | |
| SM01831 | SM01848 | PDJN R/L 3232 P15 | 69 € | |
| SM25967 | SM25950 | PDJN R/L 4040 S15 | 108 € | |







| Ordering Code | | Item Designation | Price | Master Insert* |
|------------------|--|-------------------------|-------------|---|
| <i>Direction</i> | | PDN NN-JT (62.5) | EURO |  |
| <i>Neutral</i> | | | | |
| SM50792 | | PDN NN 2525 M15-JT | 103 € | DNM.1506.. |

Cooling accessories are optional / See Page 297 for cooling accessory.
Soğutma ekipmanları opsiyoneldir / Bkz. Sayfa 297 Soğutma aksesuarları için



| Ordering Code | | Item Designation | Price | Master Insert* |
|------------------|--|----------------------|-------------|---|
| <i>Direction</i> | | PDN NN (62.5) | EURO |  |
| <i>Neutral</i> | | | | |
| SM25943 | | PDN NN 2020 K15 | 56 € | DNM.1506.. |
| SM22409 | | PDN NN 2525 M15 | 108 € | |
| SM25936 | | PDN NN 3232 P15 | 69 € | |
| SM34297 | | PDN NN 4040 S15 | 108 € | |

| Size Designation | Master Insert* | Spare Parts | | | | |
|------------------|----------------|---|---|---|--|---|
| | | <i>Lever</i> | <i>Lever Screw</i> | <i>Shim</i> | <i>Shim Spring</i> | <i>Allen Key</i> |
| 2020 - 4040 | DNM.1506.. |  SPL4 9123 |  SLV4 M8x21 9229 |  BAX DN15-9602 |  SLAY1 9701 |  SAK-AA3-9902 |

*Suitable Insert is ISO

**Spare Parts Ordering Codes



| Ordering Code | | Item Designation | Price | Master Insert* |
|------------------|-------------|-------------------------|-------------|---|
| <i>Direction</i> | | <i>PCLN R/L-JT (95)</i> | <i>EURO</i> |  |
| <i>Right</i> | <i>Left</i> | | | |
| SM50846 | SM50853 | PCLN R/L 2525 M12-JT | 103 € | CNM.1204.. |
| SM50884 | SM50891 | PCLN R/L 2525 M16-JT | 110 € | CNM.1606.. |
| | | | | |





Cooling accessories are optional / See Page 297 for cooling accessory.
Soğutma ekipmanları opsiyoneldir / Bkz. Sayfa 297 Soğutma aksesuarları için



| Ordering Code | | Item Designation | Price | Master Insert* |
|------------------|-------------|----------------------|-------------|---|
| <i>Direction</i> | | <i>PCLN R/L (95)</i> | <i>EURO</i> |  |
| <i>Right</i> | <i>Left</i> | | | |
| SM01619 | SM01626 | PCLN R/L 2020 K12 | 56 € | CNM.1204.. |
| SM01640 | SM01657 | PCLN R/L 2525 M12 | 59 € | |
| SM01671 | SM01688 | PCLN R/L 3232 P12 | 69 € | CNM.1606.. |
| SM01701 | SM01718 | PCLN R/L 2525 M16 | 58 € | |
| SM01732 | SM01749 | PCLN R/L 3232 P16 | 80 € | CNM.1906.. |
| SM01763 | SM01770 | PCLN R/L 3232 P19 | 91 € | |
| SM25905 | SM25899 | PCLN R/L 4040 S19 | 121 € | |



| Ordering Code | | Item Designation | Price | Master Insert* |
|------------------|-------------|----------------------|-------------|---|
| <i>Direction</i> | | <i>PCBN R/L (75)</i> | <i>EURO</i> |  |
| <i>Right</i> | <i>Left</i> | | | |
| SM34204 | SM34198 | PCBN R/L 2020 K12 | 56 € | CNM.1204.. |
| SM22447 | SM22454 | PCBN R/L 2525 M12 | 59 € | |
| SM25868 | SM25851 | PCBN R/L 3232 P12 | 69 € | CNM.1606.. |
| SM34211 | SM34228 | PCBN R/L 2525 M16 | 69 € | |
| SM34235 | SM34242 | PCBN R/L 3232 P16 | 80 € | CNM.1906.. |
| SM34266 | SM34259 | PCBN R/L 3232 P19 | 91 € | |
| SM34273 | SM34280 | PCBN R/L 4040 S19 | 121 € | |

| Size Designation | Master Insert* | Spare Parts | | | | |
|------------------|----------------|---|---|--|---|---|
| | | <i>Lever</i> | <i>Lever Screw</i> | <i>Shim</i> | <i>Shim Spring</i> | <i>Allen Key</i> |
| 2020 - 3232 | CNM.1204.. |  |  |  |  |  |
| 2525 - 3232 | CNM.1606.. | SPL1-9120 | SLV1 M8x20-9224 | BAX CN12-9603 | SLAY1-9701 | |
| 3232 - 4040 | CNM.1906.. | SPL2-9121 | SLV2 M8x24-9225 | BAX CN16-9604 | SLAY2-9702 | SAK-AA3-9902 |
| | | SPL3-9122 | SLV3 M10x29-9226 | BAX CN19-9605 | SLAY3-9703 | SAK-AA4-9903 |









| Ordering Code | Item Designation | Price | Master Insert* |
|------------------|----------------------|-------------|---|
| <i>Direction</i> | PCMNN-JT (50) | EURO |  |
| <i>Neutral</i> | | | |
| SM50969 | PCMNN 2525 M12-JT | 103 € | CNM.1204.. |
| SM50983 | PCMNN 2525 M16-JT | 110 € | CNM.1606.. |

Cooling accessories are optional / See Page 297 for cooling accessory.
Soğutma ekipmanları opsiyoneldir / Bkz. Sayfa 297 Soğutma aksesuarları için



| Ordering Code | Item Designation | Price | Master Insert* |
|------------------|-------------------|-------------|---|
| <i>Direction</i> | PCMNN (50) | EURO |  |
| <i>Neutral</i> | | | |
| SM01633 | PCMNN 2020 K12 | 56 € | CNM.1204.. |
| SM01664 | PCMNN 2525 M12 | 59 € | |
| SM01695 | PCMNN 3232 P12 | 69 € | CNM.1606.. |
| SM01725 | PCMNN 2525 M16 | 69 € | |
| SM01756 | PCMNN 3232 P16 | 80 € | CNM.1906.. |
| SM01787 | PCMNN 3232 P19 | 91 € | |
| SM34129 | PCMNN 4040 S19 | 110 € | |

| Size Designation | Master Insert* | Spare Parts | | | | |
|------------------|---|---|---|--|---|---|
| | | Lever | Lever Screw | Shim | Shim Spring | Allen Key |
| 2020 - 3232 |  |  |  |  |  |  |
| 2020 - 3232 | CNM.1204.. | SPL1-9120 | SLV1 M8x20-9224 | BAX CN12-9603 | SLAY1-9701 | SAK-AA3-9902 |
| 2525 - 3232 | CNM.1606.. | SPL2-9121 | SLV2 M8x24-9225 | BAX CN16-9604 | SLAY2-9702 | |
| 3232 - 4040 | CNM.1906.. | SPL3-9122 | SLV3 M10x29-9226 | BAX CN19-9605 | SLAY3-9703 | SAK-AA4-9903 |

*Suitable Insert is ISO

**Spare Parts Ordering Codes



| Ordering Code | | Item Designation | Price | Master Insert* |
|------------------|-------------|-------------------------|-------------|---|
| <i>Direction</i> | | PWLN R/L-JT (95) | EURO |  |
| <i>Right</i> | <i>Left</i> | | | |
| SM50525 | SM50518 | PWLN R/L 2525 M08-JT | 103 € | WNM.0804.. |
| | | | | |
| | | | | |

Cooling accessories are optional / See Page 297 for cooling accessory.
Soğutma ekipmanları opsiyoneldir / Bkz. Sayfa 297 Soğutma aksesuarları için



| Ordering Code | | Item Designation | Price | Master Insert* |
|------------------|-------------|----------------------|-------------|---|
| <i>Direction</i> | | PWLN R/L (95) | EURO |  |
| <i>Right</i> | <i>Left</i> | | | |
| SM01985 | SM01992 | PWLN R/L 2020 K08 | 56 € | WNM.0804.. |
| SM02005 | SM02012 | PWLN R/L 2525 M08 | 59 € | |
| SM02029 | SM02036 | PWLN R/L 3232 P08 | 69 € | |
| SM25929 | SM25912 | PWLN R/L 4040 S08 | 108 € | |

| Size Designation | Master Insert* | Spare Parts | | | | |
|------------------|---|---|---|--|---|---|
| |  | <i>Lever</i> | <i>Lever Screw</i> | <i>Shim</i> | <i>Shim Spring</i> | <i>Allen Key</i> |
| | |  |  |  |  |  |
| 2020 - 4040 | WNM.0804.. | SPL1-9120 | SLV1 M8x20-9224 | BAX WN08-9607 | SLAY1-9701 | SAK-AA3-9902 |



| Ordering Code | | Item Designation | Price | Master Insert* |
|------------------|-------------|----------------------|-------------|---|
| <i>Direction</i> | | <i>PSSN R/L (45)</i> | <i>EURO</i> |  |
| <i>Right</i> | <i>Left</i> | | | |
| SM01855 | SM01862 | PSSN R/L 2020 K12 | 56 € | SNM.1204.. |
| SM01886 | SM01893 | PSSN R/L 2525 M12 | 59 € | |
| SM01916 | SM01923 | PSSN R/L 3232 P12 | 69 € | SNM.1506.. |
| SM49215 | SM49222 | PSSN R/L 2525 M15 | 69 € | |
| SM01954 | SM01961 | PSSN R/L 3232 P15 | 80 € | SNM.1906 |
| SM34136 | SM34143 | PSSN R/L 3232 P19 | 91 € | |
| SM34150 | SM34167 | PSSN R/L 4040 S19 | 121 € | |







| Ordering Code | | Item Designation | Price | Master Insert* |
|------------------|-------------|----------------------|-------------|---|
| <i>Direction</i> | | <i>PSKN R/L (75)</i> | <i>EURO</i> |  |
| <i>Right</i> | <i>Left</i> | | | |
| SM26025 | SM26018 | PSKN R/L 2020 K12 | 56 € | SNM.1204.. |
| SM22386 | SM22393 | PSKN R/L 2525 M12 | 59 € | |
| SM26001 | SM25998 | PSKN R/L 3232 P12 | 69 € | SNM.1506.. |
| SM22461 | SM22478 | PSKN R/L 2525 M15 | 69 € | |
| SM25981 | SM25974 | PSKN R/L 3232 P15 | 80 € | SNM.1906 |
| SM37564 | SM37557 | PSKN R/L 3232 P19 | 91 € | |
| SM37571 | SM37540 | PSKN R/L 4040 S19 | 121 € | |



| Ordering Code | | Item Designation | Price | Master Insert* |
|------------------|-------------|----------------------|-------------|---|
| <i>Direction</i> | | <i>PSBN R/L (75)</i> | <i>EURO</i> |  |
| <i>Right</i> | <i>Left</i> | | | |
| SM34303 | SM34310 | PSBN R/L 2020 K12 | 56 € | SNM.1204.. |
| SM22423 | SM22430 | PSBN R/L 2525 M12 | 59 € | |
| SM25882 | SM25875 | PSBN R/L 3232 P12 | 69 € | SNM.1506.. |
| SM34327 | SM34334 | PSBN R/L 2525 M15 | 69 € | |
| SM34341 | SM34358 | PSBN R/L 3232 P15 | 80 € | SNM.1906 |
| SM34365 | SM34372 | PSBN R/L 3232 P19 | 91 € | |
| SM34396 | SM34389 | PSBN R/L 4040 S19 | 121 € | |



| Ordering Code | | Item Designation | Price | Master Insert* |
|------------------|--|-------------------|-------------|---|
| <i>Direction</i> | | <i>PSDNN (45)</i> | <i>EURO</i> |  |
| <i>Neutral</i> | | | | |
| SM01879 | | PSDNN 2020 K12 | 56 € | SNM.1204.. |
| SM01909 | | PSDNN 2525 M12 | 59 € | |
| SM01930 | | PSDNN 3232 P12 | 69 € | SNM.1506.. |
| SM01947 | | PSDNN 2525 M15 | 62 € | |
| SM01978 | | PSDNN 3232 P15 | 80 € | SNM.1906 |
| SM34174 | | PSDNN 3232 P19 | 91 € | |
| SM34181 | | PSDNN 4040 S19 | 121 € | |

| Size Designation | Master Insert* | Spare Parts | | | | |
|------------------|----------------|---|---|--|---|------------------|
| | | <i>Lever</i> | <i>Lever Screw</i> | <i>Shim</i> | <i>Shim Spring</i> | <i>Allen Key</i> |
| 2020 - 3232 | SNM.1204.. |  |  |  |  | SAK-AA3-9902 |
| 2525 - 3232 | SNM.1506.. | SPL2-9121 | SLV2 M8x24-9225 | BAX SN15-9609 | SLAY2-9702 | |
| 3232 - 4040 | SNM.1906 | SPL3-9122 | SLV3 M10x29-9226 | BAX SN19-9629 | SLAY3-9703 | SAK-AA4-9903 |

*Suitable Insert is ISO







**Spare Parts Ordering Codes



| Ordering Code | | Item Designation | Price | Master Insert* |
|------------------|-------------|----------------------|-------------|---|
| <i>Direction</i> | | MTJN R/L (93) | <i>EURO</i> |  |
| <i>Right</i> | <i>Left</i> | | | |
| SM01268 | SM01329 | MTJN R/L 2020 K16 | 56 € | TNM.1604.. |
| SM01275 | SM01282 | MTJN R/L 2525 M16 | 59 € | |
| SM01305 | SM01312 | MTJN R/L 3232 P16 | 67 € | |
| SM01398 | SM01374 | MTJN R/L 2525 M22 | 59 € | TNM.2204.. |
| SM01404 | SM01381 | MTJN R/L 3232 P22 | 69 € | |
| SM01336 | SM01350 | MTJN R/L 4040 S22 | 125 € | |



| Ordering Code | | Item Designation | Price | Master Insert* |
|------------------|--|-------------------|-------------|---|
| <i>Direction</i> | | MTENN (60) | <i>EURO</i> |  |
| <i>Neutral</i> | | | | |
| SM01251 | | MTENN 2020 K16 | 56 € | TNM.1604.. |
| SM01299 | | MTENN 2525 M16 | 59 € | |
| SM01244 | | MTENN 3232 P16 | 67 € | |
| SM01367 | | MTENN 2525 M22 | 59 € | TNM.2204.. |
| SM01411 | | MTENN 3232 P22 | 69 € | |
| SM01343 | | MTENN 4040 S22 | 125 € | |







| Size Designation | Master Insert* | Spare Parts | | | | | |
|------------------|---|---|---|---|---|---|---|
| | | Clamp | Screw | Shim | Pin | Spring | Allen Key |
| 2020 |  |  |  |  |  |  |  |
| 2525 - 3232 | | | | | | | |
| 2525 - 4040 | | | | | | | |
| | TNM.1604.. | MSK1-9107 | TSBV M6x27-9203 | BAX TN16-9610 | BMP1 3.70x5x17 9309 | TSP 6.5x12-9705 | SAK- AA3-9902 |
| | TNM.2204.. | | TSBV M6x30-9205 | BAX TN22-9611 | BMP2 5x6x16-9310 | | |



| Ordering Code | | Item Designation | Price | Master Insert* |
|------------------|-------------|----------------------|-------------|---|
| <i>Direction</i> | | <i>MWLN R/L (95)</i> | <i>EURO</i> |  |
| <i>Right</i> | <i>Left</i> | | | |
| SM01428 | SM01435 | MWLN R/L 1616 H06 | 50 € | WNM.0604.. |
| SM01459 | SM01466 | MWLN R/L 2020 K06 | 53 € | |
| SM01473 | SM01480 | MWLN R/L 2525 M06 | 58 € | |
| SM01534 | SM01497 | MWLN R/L 2020 K08 | 56 € | WNM.0804.. |
| SM01558 | SM01572 | MWLN R/L 2525 M08 | 59 € | |
| SM01602 | SM01589 | MWLN R/L 3232 P08 | 69 € | |
| SM01527 | SM25776 | MWLN R/L 4040 S08 | 111 € | |



| Ordering Code | | Item Designation | Price | Master Insert* |
|------------------|--|-------------------|-------------|---|
| <i>Direction</i> | | <i>MWDNN (50)</i> | <i>EURO</i> |  |
| <i>Neutral</i> | | | | |
| SM01442 | | MWDNN 1616 H06 | 50 € | WNM.0604.. |
| SM01503 | | MWDNN 2020 K06 | 53 € | |
| SM01510 | | MWDNN 2525 M06 | 58 € | |
| SM01541 | | MWDNN 2020 K08 | 56 € | WNM.0804.. |
| SM01565 | | MWDNN 2525 M08 | 59 € | |
| SM01596 | | MWDNN 3232 P08 | 69 € | |
| SM25769 | | MWDNN 4040 S08 | 111 € | |







| Size Designation | Master Insert* | Spare Parts | | | | | |
|------------------|---|---|---|---|---|---|---|
| | | Clamp | Screw | Shim | Pin | Spring | Allen Key |
| 1616 |  |  |  |  |  |  |  |
| 2020 - 2525 | | | | | | | |
| 2020 - 4040 | WNM.0804.. | MSK3-9109 | TSBV M6x30 9205 | BAX WNO8 9607 | BMP3 5x6x17 9311 | TSP 6.5X12 9705 | |

*Suitable Insert is ISO

**Spare Parts Ordering Codes









| Ordering Code | | Item Designation | Price | Master Insert* |
|------------------|-------------|----------------------|-------------|---|
| <i>Direction</i> | | CDJN R/L (93) | <i>EURO</i> |  |
| <i>Right</i> | <i>Left</i> | | | |
| SM02043 | SM02050 | CDJN R/L 2525 M15 | 67 € | DN.N 1507.. |
| SM02067 | SM02074 | CDJN R/L 3232 P15 | 75 € | |

| Size Designation | Master Insert* | Spare Parts | | | | | |
|------------------|---|---|---|--|--|---|---|
| |  | Wedge Clamp | Clamp Screw | Shim | Shim Screw | Ring | Allen Key |
| 2525 - 3232 | DN.N 1507.. |  CSK5 9115 |  CSBV M8x30x11 9208 |  BAX DN15 9602 |  TSAV M4x10 9403 |  CSS1 |  SAK- AA4-9903 |



| Ordering Code | | Item Designation | Price | Master Insert* |
|------------------|-------------|----------------------|-------------|---|
| <i>Direction</i> | | CCLN R/L (95) | <i>EURO</i> |  |
| <i>Right</i> | <i>Left</i> | | | |
| SM44807 | SM44814 | CCLN R/L 2525 M12 | 67 € | CN.N 1207. |
| SM44821 | SM44838 | CCLN R/L 3232 P12 | 75 € | |

| Size Designation | Master Insert* | Spare Parts | | | | | |
|------------------|---|---|---|--|--|---|---|
| |  | Wedge Clamp | Clamp Screw | Shim | Shim Screw | Ring | Allen Key |
| 2525 - 3232 | CN.N 1207. |  CSK5 9115 |  CSBV M8x30x11 9208 |  BAX CN12 9603 |  TSAV M4x10 9403 |  CSS1 |  SAK- AA4-9903 |

EXTERNAL TURNING TOOLS











| Ordering Code | | Item Designation | Price | Master Insert* |
|------------------|-------------|----------------------|-------------|---|
| <i>Direction</i> | | CSSN R/L (45) | <i>EURO</i> |  |
| <i>Right</i> | <i>Left</i> | | | |
| SM02142 | SM02159 | CSSN R/L 2525 M12 | 67 € | SN.N 1207.. |
| SM02173 | SM02180 | CSSN R/L 3232 P12 | 75 € | |



| Ordering Code | | Item Designation | Price | Master Insert* |
|------------------|-------------|----------------------|-------------|---|
| <i>Direction</i> | | CSKN R/L (75) | <i>EURO</i> |  |
| <i>Right</i> | <i>Left</i> | | | |
| SM44845 | SM44852 | CSKN R/L 2525 M12 | 67 € | SN.N 1207.. |
| SM44869 | SM44876 | CSKN R/L 3232 P12 | 75 € | |



| Ordering Code | | Item Designation | Price | Master Insert* |
|------------------|--|-------------------|-------------|---|
| <i>Direction</i> | | CSDNN (45) | <i>EURO</i> |  |
| <i>Neutral</i> | | | | |
| SM02166 | | CSDNN 2525 M12 | 67 € | SN.N 1207.. |
| SM02197 | | CSDNN 3232 P12 | 75 € | |







| Size Designation | Master Insert* | Spare Parts | | | | | |
|------------------|--|---|---|--|--|---|---|
| | | Wedge Clamp | Clamp Screw | Shim | Shim Screw | Ring | Allen Key |
| 2525 - 3232 |  SN.N 1207.. |  CSK5 9115 |  CSBV M8x30x11 9208 |  BAX SN12 9608 |  TSAV M4x10 9403 |  CSS1 |  SAK- AA4-9903 |

*Suitable Insert is ISO

**Spare Parts Ordering Codes









| Ordering Code | | Item Designation | Price | Master Insert* |
|------------------|-------------|----------------------|-------------|---|
| <i>Direction</i> | | CTJN R/L (93) | EURO |  |
| <i>Right</i> | <i>Left</i> | | | |
| SM02203 | SM02210 | CTJN R/L 2525 M16 | 75 € | TN.N 1607. |
| SM02227 | SM02234 | CTJN R/L 3232 P16 | 67 € | |

| Size Designation | Master Insert* | Spare Parts | | | | | |
|------------------|---|---|---|---|---|---|---|
| |  | Wedge Clamp | Clamp Screw | Shim | Shim Screw | Ring | Allen Key |
| 2525 - 3232 | TN.N 1607. |  |  |  |  |  |  |
| | | CSK4-9114 | CSBV M8x30x11 9208 | BAX TN16 9610 | TSAV M4x10x7-9413 | CSS1 | SAK- AA4-9903 |



| Ordering Code | | Item Designation | Price | Master Insert* |
|------------------|-------------|----------------------|-------------|---|
| <i>Direction</i> | | CKJN R/L (93) | EURO |  |
| <i>Right</i> | <i>Left</i> | | | |
| SM02081 | SM02128 | CKJN R/L 2020 K16 | 46 € | KNUX- R/L 1604.. |
| SM02098 | SM02104 | CKJN R/L 2525 M16 | 50 € | |
| SM02111 | SM02135 | CKJN R/L 3232 P16 | 67 € | |
| SM24663 | SM25363 | CKJN R/L 4040 S16 | 111 € | |

| Size Designation | Master Insert* | Spare Parts | | | | |
|------------------|---|---|---|--|---|---|
| |  | Wedge Clamp | Clamp Screw | Shim | Shim Screw | Allen Key |
| 2020 | KNUX-R/L 1604.. |  |  |  |  |  |
| 2525 - 4040 | | CSK3/R-9117 CSK3/L-9118 | BKTV M6x26-9233 | BAX-KN16/R-9621 BAX-KN16/L-9622 | CSAV M3x8 9401 | SAK-AA5-9904 |



| Ordering Code | | Item Designation | Price | Master Insert* |
|------------------|-------------|-------------------------|-------------|----------------|
| <i>Direction</i> | | SDJC R/L-JT (93) | EURO | |
| <i>Right</i> | <i>Left</i> | | | |
| SM57890 | SM57906 | SDJC R/L 2525 M11-JT | 94 € | DCM. 11T3.. |
| | | | | |

Cooling accessories are optional / See Page 297 for cooling accessory.
Soğutma ekipmanları opsiyoneldir / Bkz. Sayfa 297 Soğutma aksesuarları için



| Ordering Code | | Item Designation | Price | Master Insert* |
|------------------|-------------|----------------------|-------------|----------------|
| <i>Direction</i> | | SDJC R/L (93) | EURO | |
| <i>Right</i> | <i>Left</i> | | | |
| SM02678 | SM02685 | SDJC R/L 0808 E07 | 33 € | DCM. 0702.. |
| SM02623 | SM02630 | SDJC R/L 1010 E07 | 33 € | |
| SM02562 | SM02609 | SDJC R/L 1212 F07 | 33 € | |
| SM02579 | SM02593 | SDJC R/L 1616 H07 | 40 € | DCM. 11T3.. |
| SM38745 | SM38738 | SDJC R/L 1212 F11 | 39 € | |
| SM02760 | SM02777 | SDJC R/L 1616 H11 | 43 € | |
| SM02791 | SM02784 | SDJC R/L 2020 K11 | 45 € | |
| SM02821 | SM02838 | SDJC R/L 2525 M11 | 46 € | |
| SM02883 | SM02869 | SDJC R/L 3232 P11 | 56 € | |



| Ordering Code | | Item Designation | Price | Master Insert* |
|------------------|--|------------------------|-------------|----------------|
| <i>Direction</i> | | SDNCN-JT (62.5) | EURO | |
| <i>Neutral</i> | | | | |
| SM57913 | | SDNCN 2525 M11-JT | 94 € | DCM. 11T3.. |
| | | | | |

Cooling accessories are optional / See Page 297 for cooling accessory.
Soğutma ekipmanları opsiyoneldir / Bkz. Sayfa 297 Soğutma aksesuarları için



| Ordering Code | | Item Designation | Price | Master Insert* |
|------------------|--|---------------------|-------------|----------------|
| <i>Direction</i> | | SDNCN (62.5) | EURO | |
| <i>Neutral</i> | | | | |
| SM02692 | | SDNCN 0808 E07 | 33 € | DCM. 0702.. |
| SM02647 | | SDNCN 1010 E07 | 33 € | |
| SM02616 | | SDNCN 1212 F07 | 33 € | |
| SM02586 | | SDNCN 1616 H07 | 40 € | DCM. 11T3.. |
| SM37595 | | SDNCN 1212 F11 | 39 € | |
| SM02890 | | SDNCN 1616 H11 | 43 € | |
| SM02807 | | SDNCN 2020 K11 | 45 € | |
| SM02845 | | SDNCN 2525 M11 | 46 € | |
| SM02852 | | SDNCN 3232 P11 | 56 € | |

*Suitable Insert is ISO

**Spare Parts Ordering Codes



| Ordering Code | | Item Designation | Price | Master Insert* |
|------------------|-------------|-------------------------|-------------|----------------|
| <i>Direction</i> | | SDHC R/L (107.5) | EURO | |
| <i>Right</i> | <i>Left</i> | | | |
| SM02708 | SM02715 | SDHC R/L 0808 E07 | 33 € | DCM. 0702.. |
| SM02654 | SM02661 | SDHC R/L 1010 E07 | 33 € | |
| SM02722 | SM02739 | SDHC R/L 1212 F07 | 33 € | |
| SM02746 | SM02753 | SDHC R/L 1616 H07 | 40 € | |
| SM02906 | SM02913 | SDHC R/L 1616 H11 | 43 € | DCM. 11T3.. |
| SM02814 | SM02876 | SDHC R/L 2020 K11 | 45 € | |
| SM02920 | SM02937 | SDHC R/L 2525 M11 | 46 € | |
| SM02944 | SM02951 | SDHC R/L 3232 P11 | 56 € | |

| Size Designation | Master Insert* | Spare Parts | | | |
|------------------|----------------|-----------------------------|-----------------------|------------------------------------|----------------------|
| | | Clamp Screw | Shim | Shim Screw | Torx Key |
| | | | | | |
| 0808 - 1616 | DCM. 0702.. | SSV M2.5x6- 9505 | - | - | STK-T08- 9908 |
| 1212 - 1616 | DCM. 11T3.. | SSV M3.5x10- 9511 | BAX DC11- 9613 | SBV5 M5x0.5 A3.5x9- 9408 | STK-T15- 9910 |
| 2020 - 3232 | | SSV M3.5x14- 9512 | | M5.05 A3.5x11- 9407 | |
| 2525-JT | | SSV M3.5x10- 9511 | | SBV5 M5x0.5 A3.5x9- 9408 | |



| Ordering Code | | Item Designation | Price | Master Insert* |
|------------------|-------------|-------------------------|-------------|----------------|
| <i>Direction</i> | | SVJB R/L-JT (93) | EURO | |
| <i>Right</i> | <i>Left</i> | | | |
| SM57920 | SM57937 | SVJB R/L 2525 M16-JT | 94 € | VBM. 1604.. |

Cooling accessories are optional / See Page 297 for cooling accessory.
Soğutma ekipmanları opsiyoneldir / Bkz. Sayfa 297 Soğutma aksesuarları için



| Ordering Code | | Item Designation | Price | Master Insert* |
|------------------|-------------|----------------------|-------------|----------------|
| <i>Direction</i> | | SVJB R/L (93) | EURO | |
| <i>Right</i> | <i>Left</i> | | | |
| SM27138 | SM27145 | SVJB R/L 1212 F11 | 33 € | VBM. 1103.. |
| SM04313 | SM04320 | SVJB R/L 1616 H11 | 40 € | |
| SM04269 | SM04276 | SVJB R/L 2020 K11 | 43 € | |
| SM04283 | SM04306 | SVJB R/L 2525 M11 | 45 € | VBM. 1604.. |
| SM04504 | SM04511 | SVJB R/L 1616 H16 | 45 € | |
| SM04566 | SM04542 | SVJB R/L 2020 K16 | 46 € | |
| SM04597 | SM04580 | SVJB R/L 2525 M16 | 46 € | |
| SM04610 | SM04627 | SVJB R/L 3232 P16 | 56 € | |



| Ordering Code | | Item Designation | Price | Master Insert* |
|------------------|-------------|-------------------------|-------------|----------------|
| <i>Direction</i> | | SVHB R/L (107.5) | <i>EURO</i> | |
| <i>Right</i> | <i>Left</i> | | | |
| SM04344 | SM04399 | SVHB R/L 1616 H11 | 40 € | VBM. 1103.. |
| SM04450 | SM04412 | SVHB R/L 2020 K11 | 43 € | |
| SM04375 | SM04436 | SVHB R/L 2525 M11 | 45 € | VBM. 1604.. |
| SM04535 | SM04726 | SVHB R/L 1616 H16 | 45 € | |
| SM04573 | SM04467 | SVHB R/L 2020 K16 | 46 € | |
| SM04665 | SM04481 | SVHB R/L 2525 M16 | 46 € | |
| SM04719 | SM04696 | SVHB R/L 3232 P16 | 56 € | |



| Ordering Code | | Item Designation | Price | Master Insert* |
|------------------|-------------|-----------------------|-------------|----------------|
| <i>Direction</i> | | SVZB R/L (100) | <i>EURO</i> | |
| <i>Right</i> | <i>Left</i> | | | |
| SM04405 | SM04351 | SVZB R/L 1616 H11 | 40 € | VBM. 1103.. |
| SM04429 | SM04368 | SVZB R/L 2020 K11 | 43 € | |
| SM04443 | SM04382 | SVZB R/L 2525 M11 | 45 € | VBM. 1604.. |
| SM04733 | SM04641 | SVZB R/L 1616 H16 | 45 € | |
| SM04474 | SM04658 | SVZB R/L 2020 K16 | 46 € | |
| SM04498 | SM04672 | SVZB R/L 2525 M16 | 46 € | |
| SM04689 | SM04702 | SVZB R/L 3232 P16 | 56 € | |



| Ordering Code | | Item Designation | Price | Master Insert* |
|------------------|--|---------------------|-------------|----------------|
| <i>Direction</i> | | SVVBN (72.5) | <i>EURO</i> | |
| <i>Neutral</i> | | | | |
| SM04337 | | SVVBN 1616 H11 | 40 € | VBM. 1103.. |
| SM04245 | | SVVBN 2020 K11 | 43 € | |
| SM04290 | | SVVBN 2525 M11 | 45 € | VBM. 1604.. |
| SM04528 | | SVVBN 1616 H16 | 45 € | |
| SM04559 | | SVVBN 2020 K16 | 46 € | |
| SM04603 | | SVVBN 2525 M16 | 46 € | |
| SM04634 | | SVVBN 3232 P16 | 56 € | |

| Size Designation | Master Insert* | Spare Parts | | | |
|------------------|-----------------|------------------------|------------------|----------------------------|--------------|
| | | Clamp Screw | Shim | Shim Screw | Torx Key |
| 1616 - 2525 | VBM. 1103.. | SSV M2.5x6-9505 | - | - | STK-T08-9908 |
| 1616 | VBM. 1604.. | SSV M3.5x10-9511 | BAX VB16-9618 | SBV5 M5x0.5 A3.5x9-9408 | STK-T15-9910 |
| 2020 - 3232 | | SSV M3.5x14-9512 | | SBV M5x0.5 A3.5x11-9407 | |

*Suitable Insert is ISO

**Spare Parts Ordering Codes



| Ordering Code | | Item Designation | Price | Master Insert* |
|------------------|-------------|----------------------|-------------|----------------|
| <i>Direction</i> | | SVJC R/L (93) | <i>EURO</i> | |
| <i>Right</i> | <i>Left</i> | | | |
| SM26971 | SM26995 | SVJC R/L 1616 H11 | 40 € | VCM. 1103.. |
| SM20962 | SM27008 | SVJC R/L 2020 K11 | 43 € | |
| SM23611 | SM23635 | SVJC R/L 2020 K16 | 45 € | VCM. 1604.. |
| SM23604 | SM23628 | SVJC R/L 2525 M16 | 46 € | |
| SM26988 | SM27015 | SVJC R/L 3232 P16 | 56 € | |



| Ordering Code | | Item Designation | Price | Master Insert* |
|------------------|-------------|-------------------------|-------------|----------------|
| <i>Direction</i> | | SVHC R/L (107.5) | <i>EURO</i> | |
| <i>Right</i> | <i>Left</i> | | | |
| SM23680 | SM23734 | SVHC R/L 1616 H11 | 40 € | VCM. 1103.. |
| SM23697 | SM23758 | SVHC R/L 2020 K11 | 43 € | |
| SM23710 | SM23765 | SVHC R/L 2020 K16 | 45 € | VCM. 1604.. |
| SM23703 | SM23772 | SVHC R/L 2525 M16 | 46 € | |
| SM23727 | SM23789 | SVHC R/L 3232 P16 | 56 € | |



| Ordering Code | | Item Designation | Price | Master Insert* |
|------------------|--|---------------------|-------------|----------------|
| <i>Direction</i> | | SVVCN (72.5) | <i>EURO</i> | |
| <i>Neutral</i> | | | | |
| SM45026 | | SVVCN 1616 H11 | 40 € | VCM. 1103.. |
| SM44418 | | SVVCN 2020 K11 | 43 € | |
| SM44401 | | SVVCN 2020 K16 | 45 € | VCM. 1604.. |
| SM40199 | | SVVCN 2525 M16 | 46 € | |
| SM45064 | | SVVCN 3232 P16 | 56 € | |

| Size Designation | Master Insert* | Spare Parts | | | |
|------------------|----------------|------------------------|------------------|----------------------------|------------------|
| | | Clamp Screw | Shim | Shim Screw | Torx Key |
| 1616 - 2525 | VCM. 1103.. | SSV M2.5x6-9505 | - | - | STK-T08-9908 |
| 1616 | VCM. 1604.. | SSV M3.5x10-9511 | BAX VB16-9618 | SBV5 M5x0.5 A3.5x9-9408 | STK-T15-9910 |
| 2020 - 3232 | | SSV M3.5x14-9512 | | SBV M5x0.5 A3.5x11-9407 | |







| Ordering Code | | Item Designation | Price | Master Insert* |
|------------------|-------------|-------------------------|-------------|---|
| <i>Direction</i> | | SCLC R/L-JT (95) | EURO |  |
| <i>Right</i> | <i>Left</i> | | | |
| SM57944 | SM57951 | SCLC R/L 2525 M09-JT | 94 € | CCM.09T3.. |
| | | | | |

Cooling accessories are optional / See Page 297 for cooling accessory.
Soğutma ekipmanları opsiyoneldir / Bkz. Sayfa 297 Soğutma aksesuarları için



| Ordering Code | | Item Designation | Price | Master Insert* |
|------------------|-------------|----------------------|-------------|---|
| <i>Direction</i> | | SCLC R/L (95) | EURO |  |
| <i>Right</i> | <i>Left</i> | | | |
| SM03767 | SM03774 | SCLC R/L 0808 E06 | 33 € | CCM.0602.. |
| SM02241 | SM02258 | SCLC R/L 1010 E06 | 33 € | |
| SM27275 | SM37588 | SCLC R/L 1212 F06 | 33 € | CCM.09T3.. |
| SM02296 | SM26681 | SCLC R/L 1212 F09 | 33 € | |
| SM02340 | SM02302 | SCLC R/L 1616 H09 | 43 € | CCM.09T3.. |
| SM02326 | SM02319 | SCLC R/L 2020 K09 | 45 € | |
| SM02357 | SM02333 | SCLC R/L 2525 M09 | 46 € | CCM.1204.. |
| SM49239 | SM49246 | SCLC R/L 1616 H12 | 43 € | |
| SM02470 | SM02487 | SCLC R/L 2020 K12 | 45 € | CCM.1204.. |
| SM02463 | SM02524 | SCLC R/L 2525 M12 | 48 € | |

| Size Designation | Master Insert* | Spare Parts | | | |
|------------------|--|---|--|--|---|
| | | Clamp Screw | Shim | Shim Screw | Torx Key |
| 0808 - 1010 |  CCM. 0602.. |  SSV M2.5x6-9505 |  - |  - |  STK-T08-9908 |
| 1212 1616 | CCM. 09T3.. | SSV M3.5x10-9511 | BAX CC09-9616 | SBV5 M5x0.5 A3.5x9-9408 | STK-T15-9910 |
| 2020 - 2525 | | SSV M3.5x14-9512 | | SBV M5x0.5 A3.5x11-9407 | |
| 2525-JT | SSV M3.5x10-9511 | SBV5 M5x0.5 A3.5x9-9408 | | | |
| 1616 | CCM.1204.. | SSV M4x12x6-9517 | BAX CC12-9617 | SBV4 M6x0.75 A4x9-9411 SBV2 M6x0.75 A4x13-9410 | |
| 2020 - 2525 | | | | | |

*Suitable Insert is ISO





**Spare Parts Ordering Codes



| Ordering Code | | Item Designation | Price | Master Insert* |
|---------------|---------|-------------------|-------|---|
| Direction | | SCAC R/L (90) | EURO |  |
| Right | Left | | | |
| SM03798 | SM03804 | SCAC R/L 0808 E06 | 33 € | CCM.0602.. |
| SM02272 | SM02289 | SCAC R/L 1010 E06 | 33 € | |
| SM02388 | SM02395 | SCAC R/L 1212 F09 | 33 € | CCM.09T3.. |
| SM02418 | SM02425 | SCAC R/L 1616 H09 | 43 € | |
| SM02449 | SM02456 | SCAC R/L 2020 K09 | 45 € | |
| SM26957 | SM26964 | SCAC R/L 2525 M09 | 46 € | |
| SM02500 | SM02517 | SCAC R/L 2020 K12 | 45 € | CCM.1204.. |
| SM02548 | SM02555 | SCAC R/L 2525 M12 | 48 € | |



| Ordering Code | | Item Designation | Price | Master Insert* |
|---------------|--|------------------|-------|--|
| Direction | | SCMCN (50) | EURO |  |
| Neutral | | | | |
| SM03781 | | SCMCN 0808 E06 | 33 € | CCM.0602.. |
| SM02265 | | SCMCN 1010 E06 | 33 € | |
| SM02371 | | SCMCN 1212 F09 | 33 € | CCM.09T3.. |
| SM02401 | | SCMCN 1616 H09 | 43 € | |
| SM02432 | | SCMCN 2020 K09 | 45 € | |
| SM20993 | | SCMCN 2525 M09 | 46 € | |
| SM02494 | | SCMCN 2020 K12 | 48 € | CCM.1204.. |
| SM02531 | | SCMCN 2525 M12 | 48 € | |





| Size Designation | Master Insert* | Spare Parts | | | |
|------------------|---|--|---|---|---|
| |  | Clamp Screw  | Shim  | Shim Screw  | Torx Key  |
| 0808 - 1010 | CCM. 0602.. | SSV M2.5x6-9505 | - | - | STK-T08-9908 |
| 1212 | CCM. 09T3.. | | | | |
| 1616 | | SSV M3.5x14-9512 | SBV M5x0.5 A3.5x11-9407 | | |
| 2020 - 2525 | | SSV M3.5x10-9511 | SBV5 M5x0.5 A3.5x9-9408 | | |
| 2525-JT | | CCM.1204.. | SSV M4x12x6-9517 | SBV4 M6x0.75 A4x9-9411 | |
| 1616 | BAX CC12-9617 | | SBV2 M6x0.75 A4x13-9410 | | |
| 2020 - 2525 | | | | | |



| Ordering Code | | Item Designation | Price | Master Insert* |
|------------------|-------------|----------------------|-------------|---|
| <i>Direction</i> | | SSSC R/L (45) | <i>EURO</i> |  |
| <i>Right</i> | <i>Left</i> | | | |
| SM03521 | SM03538 | SSSC R/L 1212 F09 | 33 € | SCM. 09T3.. |
| SM03552 | SM03569 | SSSC R/L 1616 H09 | 40 € | |
| SM03576 | SM03583 | SSSC R/L 2020 K09 | 45 € | |
| SM03613 | SM03514 | SSSC R/L 2525 M09 | 46 € | |
| SM03637 | SM03644 | SSSC R/L 1616 H12 | 43 € | SCM. 1204.. |
| SM03651 | SM03668 | SSSC R/L 2020 K12 | 45 € | |
| SM03675 | SM03682 | SSSC R/L 2525 M12 | 48 € | |



| Ordering Code | | Item Designation | Price | Master Insert* |
|------------------|--|-------------------|-------------|---|
| <i>Direction</i> | | SSDCN (45) | <i>EURO</i> |  |
| <i>Neutral</i> | | | | |
| SM03545 | | SSDCN 1212 F09 | 33 € | SCM. 09T3.. |
| SM03590 | | SSDCN 1616 H09 | 40 € | |
| SM03606 | | SSDCN 2020 K09 | 45 € | |
| SM03620 | | SSDCN 2525 M09 | 46 € | |
| SM03699 | | SSDCN 1616 H12 | 43 € | SCM. 1204.. |
| SM03705 | | SSDCN 2020 K12 | 45 € | |
| SM03712 | | SSDCN 2525 M12 | 48 € | |

| Size Designation | Master Insert* | Spare Parts | | | |
|------------------|---|--|--|--|---|
| |  | Clamp Screw | Shim | Shim Screw | Torx Key |
| 1212 - 2525 | SCM. 09T3.. |  SSV M3.5x10-9511 |  - |  - |  STK-T15-9910 |
| 1616 | SCM. 1204.. | SSV M4x12x6-9517 | BAX SC12-9615 | SBV4 M6x0.75 A4x9-9411 | |
| 2020 - 2525 | | | | SBV2 M6x0.75 A4x13-9410 | |

*Suitable Insert is ISO

**Spare Parts Ordering Codes



| Ordering Code | | Item Designation | Price | Master Insert* |
|---------------|---------|----------------------|-------------|----------------|
| Direction | | <i>STJC R/L (93)</i> | <i>EURO</i> | |
| Right | Left | | | |
| SM03811 | SM03828 | STJC R/L 0808 E09 | 33 € | TCM.0902.. |
| SM03729 | SM03736 | STJC R/L 1010 E09 | 33 € | |
| SM03897 | SM03903 | STJC R/L 1212 F11 | 33 € | TCM.1102.. |
| SM03927 | SM03934 | STJC R/L 1616 H11 | 40 € | |
| SM04054 | SM04061 | STJC R/L 1616 H16 | 43 € | TCM.16T3.. |
| SM04023 | SM04016 | STJC R/L 2020 K16 | 45 € | |
| SM04047 | SM04030 | STJC R/L 2525 M16 | 46 € | |
| SM04078 | SM04085 | STJC R/L 3232 P16 | 56 € | |



| Ordering Code | | Item Designation | Price | Master Insert* |
|---------------|---------|----------------------|-------------|----------------|
| Direction | | <i>STGC R/L (90)</i> | <i>EURO</i> | |
| Right | Left | | | |
| SM03835 | SM03842 | STGC R/L 0808 E09 | 33 € | TCM.0902.. |
| SM03743 | SM03750 | STGC R/L 1010 E09 | 33 € | |
| SM03910 | SM03941 | STGC R/L 1212 F11 | 33 € | TCM.1102.. |
| SM03972 | SM03989 | STGC R/L 1616 H11 | 40 € | |
| SM04092 | SM04108 | STGC R/L 1616 H16 | 43 € | TCM.16T3.. |
| SM04139 | SM04146 | STGC R/L 2020 K16 | 45 € | |
| SM04177 | SM04184 | STGC R/L 2525 M16 | 46 € | |
| SM04221 | SM04214 | STGC R/L 3232 P16 | 56 € | |



| Ordering Code | | Item Designation | Price | Master Insert* |
|---------------|---------|----------------------|-------------|----------------|
| Direction | | <i>STFC R/L (90)</i> | <i>EURO</i> | |
| Right | Left | | | |
| SM03873 | SM03880 | STFC R/L 0808 E09 | 33 € | TCM.0902.. |
| SM03866 | SM03859 | STFC R/L 1010 E09 | 33 € | |
| SM03958 | SM03965 | STFC R/L 1212 F11 | 33 € | TCM.1102.. |
| SM03996 | SM04009 | STFC R/L 1616 H11 | 40 € | |
| SM04115 | SM04122 | STFC R/L 1616 H16 | 43 € | TCM.16T3.. |
| SM04153 | SM04160 | STFC R/L 2020 K16 | 45 € | |
| SM04191 | SM04207 | STFC R/L 2525 M16 | 46 € | |
| SM26582 | SM04238 | STFC R/L 3232 P16 | 56 € | |



| Ordering Code | | Item Designation | Price | Master Insert* |
|---------------|---------|-------------------|-------------|----------------|
| Direction | | <i>STNCN (90)</i> | <i>EURO</i> | |
| Neutral | | | | |
| SM44432 | SM44425 | STNCN 2020 K11 | 50 € | TCM.1102.. |
| SM44425 | SM45095 | STNCN 2020 K16 | 50 € | |
| SM45095 | SM45101 | STNCN 2525 M16 | 51 € | TCM.16T3.. |
| SM45101 | | STNCN 3232 P16 | 62 € | |

| Size Designation | Master Insert* | Spare Parts | | | |
|------------------|----------------|--|------------------|----------------------------|--------------|
| | | Clamp Screw | Shim | Shim Screw | Torx Key |
| 0808 - 1010 | | | | | |
| 1212 - 2020 | TCM.0902.. | SSV M2.2x5-9503 | - | - | STK-T06-9906 |
| 1616 | TCM.1102.. | SSV M2.5x6-9505 | BAX TC16-9619 | SBV5 M5x0.5 A3.5x9-9408 | STK-T08-9908 |
| 2020 - 3232 | TCM.16T3.. | SSV M3.5x10-9511 SSV M3.5x14-9512 | BAX TC16-9619 | SBV M5x0.5 A3.5x11-9407 | STK-T15-9910 |



| Ordering Code | | Item Designation | Price | Master Insert* |
|------------------|-------------|---------------------|-------------|---|
| <i>Direction</i> | | SRGC R/L (-) | <i>EURO</i> |  |
| <i>Right</i> | <i>Left</i> | | | |
| SM27190 | SM27213 | SRGC R/L 1616 H06 | 40 € | RC.T 0602.. |
| SM26568 | SM26575 | SRGC R/L 2020 K06 | 43 € | |
| SM26728 | SM26735 | SRGC R/L 2525 M06 | 45 € | RC.T 0803.. |
| SM03040 | SM03057 | SRGC R/L 1616 H08 | 40 € | |
| SM02999 | SM03002 | SRGC R/L 2020 K08 | 43 € | |
| SM02982 | SM03019 | SRGC R/L 2525 M08 | 45 € | |
| SM03026 | SM26940 | SRGC R/L 3232 P08 | 53 € | RC.T 10T3.. |
| SM03194 | SM03200 | SRGC R/L 1616 H10 | 40 € | |
| SM03101 | SM03118 | SRGC R/L 2020 K10 | 43 € | |
| SM03088 | SM03125 | SRGC R/L 2525 M10 | 45 € | RC.T 1204.. |
| SM03132 | SM03217 | SRGC R/L 3232 P10 | 53 € | |
| SM03255 | SM03262 | SRGC R/L 2020 K12 | 43 € | RC.T 1605.. |
| SM03248 | SM03279 | SRGC R/L 2525 M12 | 45 € | |
| SM03286 | SM03323 | SRGC R/L 3232 P12 | 53 € | RC.T 2006.. |
| SM03361 | SM03378 | SRGC R/L 2525 M16 | 45 € | |
| SM03385 | SM03422 | SRGC R/L 3232 P16 | 53 € | |
| SM03460 | SM03477 | SRGC R/L 2525 M20 | 45 € | |
| SM03491 | SM03507 | SRGC R/L 3232 P20 | 53 € | |



| Ordering Code | | Item Designation | Price | Master Insert* |
|------------------|-------------|---------------------|-------------|---|
| <i>Direction</i> | | SRHC R/L (-) | <i>EURO</i> |  |
| <i>Right</i> | <i>Left</i> | | | |
| SM03163 | SM03170 | SRHC R/L 2020 K10 | 77 € | RC.T 10T3.. |
| SM03156 | SM03149 | SRHC R/L 2525 K10 | 81 € | |
| SM03309 | SM03316 | SRHC R/L 2020 K12 | 77 € | RC.T 1204.. |
| SM03330 | SM03347 | SRHC R/L 2525 K12 | 81 € | |
| SM03408 | SM03415 | SRHC R/L 2020 K16 | 77 € | RC.T 1605.. |
| SM03439 | SM03446 | SRHC R/L 2525 K16 | 81 € | |

*Suitable Insert is ISO



**Spare Parts Ordering Codes



| Ordering Code | Item Designation | Price | Master Insert* |
|------------------|------------------|-------------|---|
| <i>Direction</i> | | <i>EURO</i> |  |
| <i>Neutral</i> | | | |
| SM27152 | SRDCN 1616 H06 | 40 € | RC.T 0602.. |
| SM26551 | SRDCN 2020 K06 | 43 € | |
| SM27169 | SRDCN 2525 M06 | 45 € | |
| SM03033 | SRDCN 1616 H08 | 40 € | RC.T 0803.. |
| SM02968 | SRDCN 2020 K08 | 43 € | |
| SM02975 | SRDCN 2525 M08 | 45 € | |
| SM27183 | SRDCN 3232 P08 | 53 € | |
| SM03187 | SRDCN 1616 H10 | 40 € | RC.T 10T3.. |
| SM03064 | SRDCN 2020 K10 | 43 € | |
| SM03071 | SRDCN 2525 M10 | 45 € | |
| SM03095 | SRDCN 3232 P10 | 53 € | |
| SM03224 | SRDCN 2020 K12 | 43 € | RC.T 1204.. |
| SM03231 | SRDCN 2525 M12 | 45 € | |
| SM03293 | SRDCN 3232 P12 | 53 € | RC.T 1605.. |
| SM03354 | SRDCN 2525 M16 | 45 € | |
| SM03392 | SRDCN 3232 P16 | 53 € | RC.T 2006.. |
| SM03453 | SRDCN 2525 M20 | 45 € | |
| SM03484 | SRDCN 3232 P20 | 53 € | |
| SM27176 | SRDCN 4040 S20 | 84 € | |



| Ordering Code | Item Designation | Price | Master Insert* | |
|---------------------|------------------|-------------------|---|-------------|
| <i>Direction</i> | | <i>EURO</i> |  | |
| <i>Right</i> | <i>Left</i> | | | |
| <i>SRXC R/L (-)</i> | | | | |
| SM49253 | SM49260 | SRXC R/L 2525 K08 | 105 € | RC.T 0803.. |
| SM49284 | SM49277 | SRXC R/L 2525 K10 | 105 € | RC.T 10T3.. |
| SM49291 | SM49307 | SRXC R/L 2525 K12 | 105 € | RC.T 1204.. |



| Size Designation | Master Insert* | Spare Parts | | | |
|------------------|---|---|------|------------|---|
| | | Clamp Screw | Shim | Shim Screw | Torx Key |
| |  |  | - | - |  |
| 1616 - 2525 | RC.T 0602.. | SSV M2.5x6-9505 | | | STK-T08-9908 |
| 1616 - 3232 | RC.T 0803.. | SSV M3x8-9508 | | | |
| 1616 - 3232 | RC.T 10T3.. | SSV M3.5x10-9511 | - | - | STK-T15-9910 |
| 2020 - 3232 | RC.T 1204.. | | | | STK-T20-9911 |
| 2525 - 3232 | RC.T 1605.. | SSV M5x13-9519 | | | |
| 2525 - 3232 | RC.T 2006.. | SSV M6x16-9520 | | | |



| Ordering Code | | Item Designation | Price | Master Insert* |
|------------------|-------------|--------------------------|-------------|---|
| <i>Direction</i> | | SDJC R/L K.O (93) | EURO |  |
| <i>Right</i> | <i>Left</i> | | | |
| SM23185 | SM23291 | SDJC R/L 1010 K07 K.O | 46 € | DCM. 0702.. |
| SM23192 | SM23307 | SDJC R/L 1212 G07 K.O | 40 € | |
| SM23208 | SM23314 | SDJC R/L 1212 K07 K.O | 46 € | |
| SM23215 | SM23321 | SDJC R/L 1616 F07 K.O | 40 € | |
| SM23222 | SM23338 | SDJC R/L 1616 K07 K.O | 46 € | |
| SM23239 | SM23345 | SDJC R/L 2020 K07 K.O | 48 € | |
| SM23246 | SM23352 | SDJC R/L 1212 G11 K.O | 40 € | DCM. 11T3.. |
| SM23253 | SM23369 | SDJC R/L 1212 K11 K.O | 46 € | |
| SM23260 | SM23376 | SDJC R/L 1616 F11 K.O | 40 € | |
| SM23277 | SM24670 | SDJC R/L 1616 K11 K.O | 46 € | |
| SM23284 | SM23390 | SDJC R/L 2020 K11 K.O | 48 € | |



| Ordering Code | | Item Designation | Price | Master Insert* |
|------------------|-------------|--------------------------|-------------|---|
| <i>Direction</i> | | SDAC R/L K.O (90) | EURO |  |
| <i>Right</i> | <i>Left</i> | | | |
| SM55391 | SM55490 | SDAC R/L 1010 K07 K.O | 46 € | DCM. 0702.. |
| SM55407 | SM55506 | SDAC R/L 1212 K07 K.O | 46 € | |
| SM55414 | SM55513 | SDAC R/L 1616 K07 K.O | 46 € | |
| SM55421 | SM55520 | SDAC R/L 1212 K11 K.O | 46 € | DCM. 11T3.. |
| SM55438 | SM55537 | SDAC R/L 1616 K11 K.O | 46 € | |

| Size Designation | Master Insert* | Spare Parts | | | |
|------------------|---|--|-----------|-----------------|---|
| |  | Clamp Screw  | Shim - | Shim Screw - | Torx Key  |
| 1010 - 2020 | DCM. 0702.. | SSV M2.5x6-9505 | - | - | STK-T08-9908 |
| 1212 - 2020 | DCM. 11T3.. | SSV M3.5x10-9511 | - | - | STK-T15-9910 |

*Suitable Insert is ISO

**Spare Parts Ordering Codes



| Ordering Code | | Item Designation | Price | Master Insert* |
|------------------|-------------|--------------------------|-------------|---|
| <i>Direction</i> | | SCLC R/L K.O (95) | EURO |  |
| <i>Right</i> | <i>Left</i> | | | |
| SM22980 | SM23086 | SCLC R/L 1010 K06 K.O | 46 € | CCM. 0602.. |
| SM23000 | SM23093 | SCLC R/L 1212 G06 K.O | 40 € | |
| SM23017 | SM23109 | SCLC R/L 1212 K06 K.O | 46 € | |
| SM23024 | SM23116 | SCLC R/L 1616 F06 K.O | 40 € | |
| SM23031 | SM23123 | SCLC R/L 1616 K06 K.O | 46 € | |
| SM22997 | SM23130 | SCLC R/L 1212 G09 K.O | 40 € | CCM. 09T3.. |
| SM23048 | SM23147 | SCLC R/L 1212 K09 K.O | 46 € | |
| SM23055 | SM23154 | SCLC R/L 1616 F09 K.O | 40 € | |
| SM23062 | SM23161 | SCLC R/L 1616 K09 K.O | 46 € | |
| SM23079 | SM23178 | SCLC R/L 2020 K09 K.O | 48 € | |



| Ordering Code | | Item Designation | Price | Master Insert* |
|------------------|-------------|--------------------------|-------------|---|
| <i>Direction</i> | | SCAC R/L K.O (90) | EURO |  |
| <i>Right</i> | <i>Left</i> | | | |
| SM55445 | SM55544 | SCAC R/L 1010 K06 K.O | 46 € | CCM. 0602.. |
| SM55452 | SM55551 | SCAC R/L 1212 K06 K.O | 46 € | |
| SM55469 | SM55568 | SCAC R/L 1616 K06 K.O | 46 € | |
| SM55476 | SM55575 | SCAC R/L 1212 K09 K.O | 46 € | CCM. 09T3.. |
| SM55483 | SM55582 | SCAC R/L 1616 K09 K.O | 46 € | |

| Size Designation | Master Insert* | Spare Parts | | | |
|------------------|---|---|------|------------|---|
| | | Clamp Screw | Shim | Shim Screw | Torx Key |
| |  |  | - | - |  |
| 1010 - 1616 | CCM. 0602.. | SSV M2.5x6-9505 | - | - | STK-T08-9908 |
| 1212 - 2020 | CCM. 09T3.. | SSV M3.5x10-9511 | - | - | STK-T15-9910 |



SWISS TYPE EXTERNAL TURNING TOOLS



| Ordering Code | | Item Designation | Price | Master Insert* |
|------------------|-------------|--------------------------|-------------|---|
| <i>Direction</i> | | <i>SVJB R/L K.O (93)</i> | <i>EURO</i> |  |
| <i>Right</i> | <i>Left</i> | | | |
| SM23406 | SM23468 | SVJB R/L 1010 K11 K.O | 46 € | VBM. 1103.. |
| SM23413 | SM23475 | SVJB R/L 1212 G11 K.O | 40 € | |
| SM23420 | SM23482 | SVJB R/L 1212 K11 K.O | 46 € | |
| SM23437 | SM23499 | SVJB R/L 1616 F11 K.O | 40 € | |
| SM23444 | SM23505 | SVJB R/L 1616 K11 K.O | 46 € | |
| SM23451 | SM23512 | SVJB R/L 2020 K11 K.O | 48 € | |







| Ordering Code | | Item Designation | Price | Master Insert* |
|------------------|-------------|--------------------------|-------------|---|
| <i>Direction</i> | | <i>SVAC R/L K.O (90)</i> | <i>EURO</i> |  |
| <i>Right</i> | <i>Left</i> | | | |
| SM45736 | SM45743 | SVAC R/L 1212 K11 K.O | 46 € | VCM. 1103.. |
| SM45750 | SM45767 | SVAC R/L 1616 K11 K.O | 46 € | VCM. 1604.. |
| SM45774 | SM45781 | SVAC R/L 1616 K16 K.O | 47 € | |
| SM45798 | SM45804 | SVAC R/L 2020 K16 K.O | 50 € | |

| Size Designation | Master Insert* | Spare Parts | | | |
|------------------|---|---|------|------------|---|
| |  | Clamp Screw | Shim | Shim Screw | Torx Key |
| 1010 - 2020 | VBM. 1103.. |  SSV M2.5x6-9505 | - | - |  STK-T08-9908 |



| Ordering Code | | Item Designation | Price | Master Insert* |
|------------------|-------------|--------------------------|-------------|---|
| <i>Direction</i> | | <i>STGC R/L K.O (90)</i> | <i>EURO</i> |  |
| <i>Right</i> | <i>Left</i> | | | |
| SM45651 | SM45668 | STGC R/L 1212 K11 K.O | 46 € | TCM.1103 |
| SM45675 | SM45682 | STGC R/L 1616 K11 K.O | 40 € | |
| SM45699 | SM45705 | STGC R/L 1616 K16 K.O | 46 € | TCM.1604 |
| SM45712 | SM51492 | STGC R/L 2020 K16 K.O | 50 € | |

| Size Designation | Master Insert* | Spare Parts | | | |
|------------------|---|--|------|------------|---|
| |  | Clamp Screw | Shim | Shim Screw | Torx Key |
| 1010 - 1616 | TCM.1103 |  SSV M2.5x6-9505 | - | - |  STK-T08-9908 |
| 1616 - 2020 | TCM.1604 |  SSV M3.5x10-9511 | - | - |  STK-T15-9910 |

*Suitable Insert is ISO

**Spare Parts Ordering Codes



| Ordering Code | Item Designation | Price |
|------------------|-------------------------|-------------|
| <i>Direction</i> | CENTERING TOOLS | <i>EURO</i> |
| - | | |
| SM20542 | 2020 CNC PUNTA 2.5x6 | 51 € |
| SM39407 | 2020 CNC PUNTA 2.5x6.30 | 51 € |
| SM27886 | 2525 CNC PUNTA 2.5x6.30 | 64 € |
| SM20573 | 2525 CNC PUNTA 2.5x6 | 64 € |
| SM20559 | 2020 CNC PUNTA 3.15x8 | 51 € |
| SM20580 | 2525 CNC PUNTA 3.15x8 | 51 € |
| SM20566 | 2020 CNC PUNTA 4x10 | 51 € |
| SM20597 | 2525 CNC PUNTA 4x10 | 64 € |



| Ordering Code | Item Designation | Price |
|------------------|---------------------------|-------------|
| <i>Direction</i> | CNC KNURLING TOOLS | <i>EURO</i> |
| - | | |
| SM20528 | 2020 CKTT 20x10 | 57 € |
| SM61019 | 2020 CKTT 20x8 | 57 € |
| SM20535 | 2525 CKTT 20x10 | 64 € |
| SM61026 | 2525 CKTT 20x8 | 64 € |

İç çap Tornalama Takım Tutucu kodlamaları / Internal tool Holder Code System(ISO)

| | | | | | | | | |
|-----------------------------|--------------------------------|------------------------------|--|--------------------------------|---|---|-----------------------------|---|
| 1 | 2 | 3 | 4 | 5 | 6 | 7 | 8 | 9 |
| S | 25 | S | T | D | U | N | R | - 15 |
| Takım tipi Type of tools | Takım çapı Diameter of tool | Takım boyu Length of tool | Elmas Sıkma sistemi Clamping system of insert | Elmas şekli Shape of insert | Takım kesme açısı Cutting angle of tools | Elmas boşaltma açısı Clearance Angle of insert | Takım yönü Hand of tools | Elmas kesme uzunluğu Length of Insert Cutting Edge |

1 Takım tipi / Tye of tool S 25 STDUNR - 15

A=Çelik gövdeli içten su vermeli / A=Steel body and with coolant hole
S=Çelik gövdeli / A=Steel body
E=Karbür Gövdeli / E=Carbide Shank

2 Takım çapı / Diameter of tool S 25 STDUNR - 15

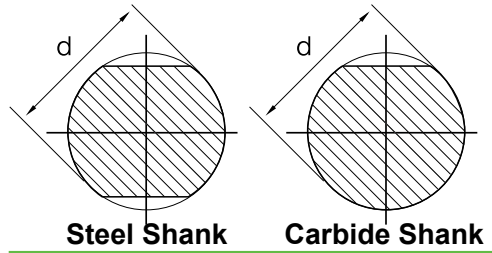

3 Takım boyu / Length of tools S 25 STDUNR - 15

| length(L) | (mm) | length(L) | (mm) |
|-----------|------|-----------|------|
| H | 100 | S | 250 |
| K | 125 | T | 300 |
| M | 150 | U | 350 |
| N | 160 | V | 400 |
| R | 200 | | |

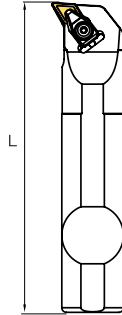

4 Elmas sıkma sistemi / Clamping system of insert S 25 STDUNR - 15

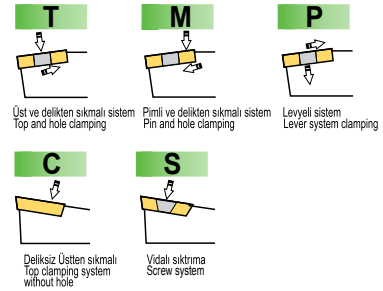

6 Takım kesme açısı / Cutting angle of tool S 25 STDUNR - 15

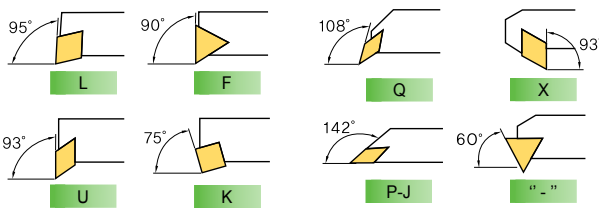

5 Takım kesme açısı / Cutting angle of tool S 25 STDUNR - 15

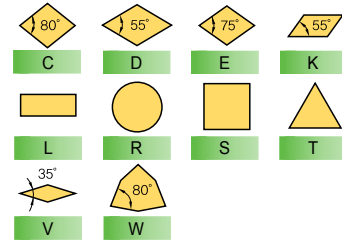

7 Şaft Genişliği / Height of Shank S 25 STDUNR - 15

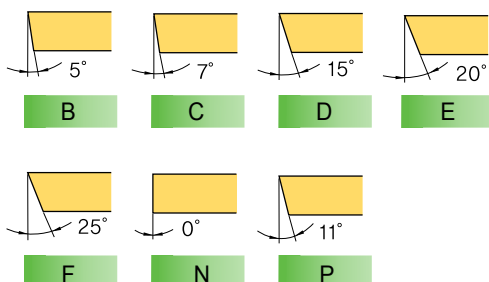



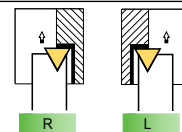









8 Takım yönü / Hand of tool S 25 STDUNR - 15

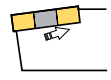
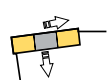
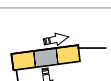
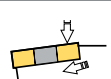
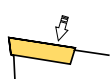







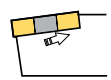
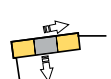
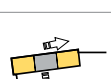
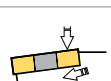
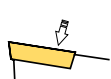





9 Elmas kesme yönü / Length of Insert Cutting Edge S 25 STDUNR - 15

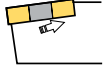
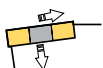

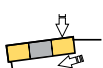
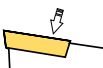





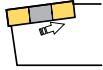
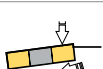
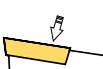





| Insert | | DNM. 1104.. ISO | DNM. 1506.. ISO | DNM. 1104.. ISO | DNM. 1506.. ISO | DNM. 1104.. ISO | DNM. 1506.. ISO | |
|-----------------|---|---|---|---|---|---|---|-----------------------------------|
| | |  |  |  |  |  |  | |
| Size (mm) | | Ø25 - Ø32 | Ø25 - Ø50 | Ø25 - Ø32 | Ø25 - Ø50 | Ø25 | Ø25 - Ø50 | |
| ISO Code | | TDUN R/L | TDUN R/L PDUN R/L | TDQN R/L | TDQN R/L PDQN R/L | TD-N R/L | TD-N R/L | |
| Cutting Angle | | 93° | 93° | 107.5° | 107.5° | 62.5° | 62.5° | |
| Clamping Type | T System |  | ✓ Size Range (mm) Ø25 - Ø32 | ✓ Size Range (mm) Ø25 - Ø50 | ✓ Size Range (mm) Ø25 - Ø32 | ✓ Size Range (mm) Ø25 - Ø50 | ✓ Size Range (mm) Ø25 | ✓ Size Range (mm) Ø32 - Ø50 |
| | Page | | B52 | B52 | B52 | B52 | B52 | B52 |
| | P System |  | - | ✓ Size Range (mm) Ø32 - Ø50 | - | ✓ Size Range (mm) Ø25 - Ø50 | - | ✓ Size Range (mm) Ø32 - Ø50 |
| | Page | | | B55 | | B55 | | |
| | A System |  | - | ✓ Size Range (mm) Ø32 | - | ✓ Size Range (mm) Ø25- Ø32 | - | - |
| | Page | | | B55 | | B55 | | |
| | M System |  | - | - | - | - | - | - |
| Page | | | | | | | | |
| C System |  | - | - | - | - | - | - | |
| Page | | | | | | | | |

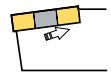
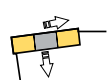
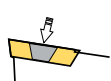
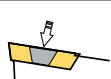
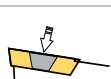





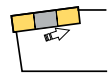
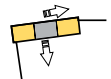
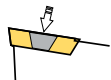
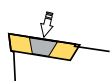
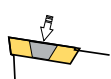

| Insert | | WNM. 0604.. ISO | WNM. 0804.. ISO | CNM. 1204.. ISO | CNM. 1606.. ISO | CNM. 1909.. ISO | SNM. 1204.. ISO | |
|-----------------|---|---|---|---|---|---|---|----------------------------------|
| | |  |  |  |  |  |  | |
| Size (mm) | | Ø20 - Ø32 | Ø25 - Ø50 | Ø20 - Ø50 | Ø32 - Ø50 | Ø40 - Ø50 | Ø25 - Ø50 | |
| ISO Code | | TWLN R/L MWLN R/L | TWLN R/L PWLN R/L MWLN R/L | TCLN R/L PCLN R/L | TCLN R/L PCLN R/L | TCLN R/L PCLN R/L | TSKN R/L PSKN R/L | |
| Cutting Angle | | 95° | 95° | 95° | 95° | 95° | 75° | |
| Clamping Type | T System |  | ✓ Size Range (mm) Ø20 - Ø32 | ✓ Size Range (mm) Ø20 - Ø50 | ✓ Size Range (mm) Ø32- Ø50 | ✓ Size Range (mm) Ø40 - Ø50 | ✓ Size Range (mm) Ø25- Ø50 | |
| | Page | | B53 | B53 | B53 | B53 | B54 | |
| | P System |  | - | ✓ Size Range (mm) Ø25 - Ø50 | ✓ Size Range (mm) Ø25 - Ø40 | ✓ Size Range (mm) Ø32- Ø50 | ✓ Size Range (mm) Ø40 - Ø50 | ✓ Size Range (mm) Ø25- Ø40 |
| | Page | | | B57 | B56 | B56 | B56 | B57 |
| | A System |  | - | ✓ Size Range (mm) Ø25- Ø32 | ✓ Size Range (mm) Ø25- Ø32 | ✓ Size Range (mm) Ø25- Ø32 | - | ✓ Size Range (mm) Ø25- Ø32 |
| | Page | | | B57 | B56 | B56 | | B56 |
| | M System |  | ✓ Size Range (mm) Ø16 - Ø25 | ✓ Size Range (mm) Ø25 - Ø50 | - | - | - | - |
| Page | | B59 | B59 | | | | | |
| C System |  | - | - | - | - | - | - | |
| Page | | | | | | | | |







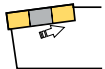
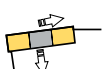
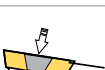

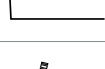
| Insert | | SNM. 1506.. ISO | VNM. 1604.. ISO | TNM. 1604.. ISO | TNM. 2204.. ISO | TNM. 1604.. ISO | TNM. 2204.. ISO | |
|-----------------|---|---|---|---|---|---|---|----------------------------------|
| | |  |  |  |  |  |  | |
| Size (mm) | | Ø25 - Ø50 | Ø25 - Ø50 | Ø20 - Ø40 | Ø32 - Ø50 | Ø20 - Ø40 | Ø32 - Ø50 | |
| ISO Code | | TSKN R/L PSKN R/L | TVUN R/L | TTUN R/L MTUN R/L | TTUN R/L MTUN R/L | MTQN R/L | MTQN R/L | |
| Cutting Angle | | 75° | 93° | 93° | | 107.5° | 107.5° | |
| Clamping Type | T System |  | ✓ Size Range (mm) Ø25- Ø50 | ✓ Size Range (mm) Ø25- Ø50 | ✓ Size Range (mm) Ø25- Ø32 | Size Range (mm) Ø32- Ø50 | - | - |
| | Page | | B54 | B54 | B54 | B54 | | |
| | P System |  | ✓ Size Range (mm) Ø32- Ø50 | - | - | - | - | - |
| | Page | | B57 | | | | | |
| | A System |  | ✓ Size Range (mm) Ø32 | - | - | - | - | - |
| | Page | | B56 | | | | | |
| | M System |  | - | - | ✓ Size Range (mm) Ø20- Ø40 | ✓ Size Range (mm) Ø32- Ø50 | ✓ Size Range (mm) Ø20- Ø40 | ✓ Size Range (mm) Ø32- Ø50 |
| | Page | | | | B58 | B58 | B58 | B58 |
| C System |  | - | - | - | - | - | - | |
| Page | | | | | | | | |







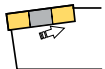
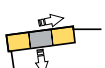
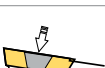

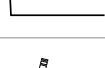
| Insert | | TNM. 1604.. ISO | TNM. 2204.. ISO | KNUX. 1604.. ISO | | | |
|-----------------|---|---|---|---|----------------------------------|--|--|
| | |  |  |  | | | |
| Size (mm) | | Ø20 - Ø40 | Ø32 - Ø50 | Ø25 - Ø50 | | | |
| ISO Code | | TT-N R/L MT-N R/L | MT-N R/L | CKUN R/L | | | |
| Cutting Angle | | 60° | 60° | 93° | | | |
| Clamping Type | T System |  | - | - | - | | |
| | Page | | B54 | B54 | | | |
| | P System |  | - | - | - | | |
| | Page | | | | | | |
| | M System |  | ✓ Size Range (mm) Ø25- Ø40 | ✓ Size Range (mm) Ø32- Ø50 | - | | |
| | Page | | B58 | B58 | | | |
| | C System |  | - | - | ✓ Size Range (mm) Ø25- Ø50 | | |
| | Page | | | | B59 | | |
| S System |  | - | - | - | | | |
| Page | | | | | | | |







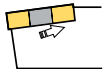
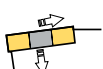
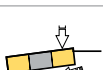

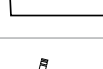
| Insert | | DCM. 0702.. ISO | DCM. 11T3.. ISO | DCM. 0702.. ISO | DCM. 11T3.. ISO | DCM. 0702.. ISO | DCM. 11T3.. ISO | |
|-----------------------------|---|---|---|---|---|---|---|----------------------------------|
| | |  |  |  |  |  |  | |
| Size (mm) | | Ø10 - Ø20 | Ø16 - Ø40 | Ø10 - Ø20 | Ø16 - Ø40 | Ø10 - Ø12 | Ø16 - Ø40 | |
| ISO Code | | SDUC R/L | SDUC R/L | SDQC R/L | SDQC R/L | SDPC R/L | SDPC R/L | |
| Cutting Angle | | 93° | 93° | 107.5° | 107.5° | 117.5° | 117.5° | |
| Clamping Type | T System |  | - | - | - | - | - | |
| | Page | | | | | | | |
| | P System |  | - | - | - | - | - | |
| | Page | | | | | | | |
| | S System |  | ✓ Size Range (mm) Ø10- Ø20 | ✓ Size Range (mm) Ø16- Ø40 | ✓ Size Range (mm) Ø10- Ø20 | ✓ Size Range (mm) Ø16- Ø40 | ✓ Size Range (mm) Ø10- Ø12 | ✓ Size Range (mm) Ø16- Ø40 |
| | Page | | B61 | B61 | B63 | B63 | B64 | B64 |
| | A System (inner hole) |  | ✓ Size Range (mm) Ø10- Ø16 | ✓ Size Range (mm) Ø16- Ø32 | ✓ Size Range (mm) Ø10- Ø16 | ✓ Size Range (mm) Ø16- Ø32 | - | - |
| | Page | | B60 | B60 | B62 | B62 | | |
| E System (Carbide Shank) |  | ✓ Size Range (mm) Ø10- Ø12 | ✓ Size Range (mm) Ø16- Ø20 | ✓ Size Range (mm) Ø10- Ø12 | ✓ Size Range (mm) Ø16- Ø20 | - | - | |
| Page | | B60 | B60 | B62 | B62 | | | |



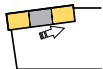
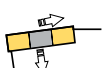
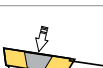

| Insert | | DCM. 0702.. ISO | DCM. 11T3.. ISO | DCM. 0702.. ISO | DCM. 11T3.. ISO | VBM. 1103.. ISO | VBM. 1604.. ISO | |
|-----------------------------|---|---|---|---|---|---|---|----------------------------------|
| | |  |  |  |  |  |  | |
| Size (mm) | | Ø12 | Ø16 - Ø40 | Ø10 - Ø16 | Ø16 - Ø40 | Ø16 - Ø20 | Ø25 - Ø40 | |
| ISO Code | | SDXC R/L | SDXC R/L | SD-C R/L | SD-C R/L | SVUB R/L | SVUB R/L | |
| Cutting Angle | | 93° | 93° | 62.5° | 62.5° | 93° | 93° | |
| Clamping Type | T System |  | - | - | - | - | - | |
| | Page | | | | | | | |
| | P System |  | - | - | - | - | - | |
| | Page | | | | | | | |
| | S System |  | ✓ Size Range (mm) Ø12 | ✓ Size Range (mm) Ø16- Ø40 | ✓ Size Range (mm) Ø10- Ø16 | ✓ Size Range (mm) Ø16- Ø40 | ✓ Size Range (mm) Ø16 - Ø20 | ✓ Size Range (mm) Ø25- Ø40 |
| | Page | | B64 | B64 | B64 | B64 | B65 | B65 |
| | A System (inner hole) |  | - | - | - | - | - | - |
| | Page | | | | | | | |
| E System (Carbide Shank) |  | - | - | - | - | - | - | |
| Page | | | | | | | | |

| Insert | | VBM. 1103.. | VBM. 1604.. | VBM. 1604.. | VBM. 1103.. | VBM. 1604.. | VBM. 1604.. | VBM. 1604.. | |
|--------------------------|--|---|---|---|--|---|---|---|----------------------------------|
| | | ISO | ISO | ISO | ISO | ISO | ISO | ISO | |
| | |  |  |  |  |  |  |  | |
| Size (mm) | | Ø16 - Ø20 | Ø25 - Ø40 | Ø25 - Ø40 | Ø16 - Ø20 | Ø25 - Ø40 | Ø25 - Ø32 | Ø25 - Ø32 | |
| ISO Code | | SVQB R/L | SVQB R/L | SVJB R/L | SVXB R/L | SVXB R/L | SVXB R/L | SV-B R/L | |
| Cutting Angle | | 107.5° | 107.5° | 93° | 52° | 52° | 52° | 72.5° | |
| Clamping Type | T System |  | - | - | - | - | - | - | |
| | Page | | | | | | | | |
| | P System |  | - | - | - | - | - | - | |
| | Page | | | | | | | | |
| | S System |  | ✓ Size Range (mm) Ø16 - Ø20 | ✓ Size Range (mm) Ø25- Ø40 | ✓ Size Range (mm) Ø25- Ø40 | ✓ Size Range (mm) Ø16- Ø20 | ✓ Size Range (mm) Ø25 - Ø40 | ✓ Size Range (mm) Ø25- Ø32 | ✓ Size Range (mm) Ø25- Ø32 |
| | Page | | B65 | B65 | B65 | B65 | B65 | B66 | |
| | A System (inner hole) |  | - | - | - | - | - | - | |
| | Page | | | | | | | | |
| E System (Carbide Shank) |  | - | - | - | - | - | - | | |
| Page | | | | | | | | | |

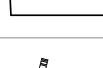
| Insert | | VCM. 1103.. | VCM. 1604.. | VCM. 1103.. | VCM. 1604.. | CCM. 0602.. | CCM. 09T3.. | |
|--------------------------|---|---|---|---|--|---|---|----------------------------------|
| | | ISO | ISO | ISO | ISO | ISO | ISO | |
| | |  |  |  |  |  |  | |
| Size (mm) | | Ø16 - Ø20 | Ø25 - Ø40 | Ø16 - Ø20 | Ø25 - Ø40 | Ø08 - Ø16 | Ø12 - Ø32 | |
| ISO Code | | SVUC R/L | SVUC R/L | SVQC R/L | SVQC R/L | SCLC R/L | SCLC R/L | |
| Cutting Angle | | 93° | 93° | 107.5° | 107.5° | 95° | 95° | |
| Clamping Type | T System |  | - | - | - | - | - | |
| | Page | | | | | | | |
| | P System |  | - | - | - | - | - | |
| | Page | | | | | | | |
| | S System |  | ✓ Size Range (mm) Ø16 - Ø20 | ✓ Size Range (mm) Ø25- Ø40 | ✓ Size Range (mm) Ø16 - Ø20 | ✓ Size Range (mm) Ø25- Ø40 | ✓ Size Range (mm) Ø08 - Ø16 | ✓ Size Range (mm) Ø12- Ø32 |
| | Page | | B66 | B66 | B66 | B66 | B68 | B68 |
| | A System (inner hole) |  | - | - | - | - | ✓ Size Range (mm) Ø08 - Ø12 | ✓ Size Range (mm) Ø16- Ø32 |
| | Page | | | | | | B67 | B67 |
| E System (Carbide Shank) |  | - | - | - | - | ✓ Size Range (mm) Ø08 - Ø12 | ✓ Size Range (mm) Ø12- Ø20 | |
| Page | | | | | | B67 | B67 | |

| Insert | | CCM. 1204.. ISO | CCM. 0602.. ISO | CCM. 09T3.. ISO | CCM. 1204.. ISO | SCM. 09T3.. ISO | SCM. 1204.. ISO |
|---------------|--|---|---|---|--|---|---|
| | |  |  |  |  |  |  |
| Size (mm) | | Ø25 - Ø40 | Ø08 - Ø12 | Ø12 - Ø25 | Ø25 - Ø40 | Ø16 - Ø25 | Ø25 - Ø40 |
| ISO Code | | SCLC R/L | SCFC R/L | SCFC R/L | SCFC R/L | SSSCR/L | SSSCR/L |
| Cutting Angle | | 95° | 90° | 90° | 90° | 45° | 45° |
| Clamping Type | T System |  | - | - | - | - | - |
| | Page | | | | | | |
| | P System |  | - | - | - | - | - |
| | Page | | | | | | |
| | M System |  | - | - | - | - | - |
| | Page | | | | | | |
| | C System |  | - | - | - | - | - |
| | Page | | | | | | |
| S System |  | ✓ Size Range (mm) Ø25 - Ø40 | ✓ Size Range (mm) Ø08 - Ø12 | ✓ Size Range (mm) Ø12 - Ø25 | ✓ Size Range (mm) Ø25 - Ø40 | ✓ Size Range (mm) Ø16 - Ø25 | ✓ Size Range (mm) Ø25 - Ø40 |
| Page | | B68 | B69 | B69 | B69 | B69 | B69 |

| Insert | | TCM. 0902.. ISO | TCM. 1102.. ISO | TCM. 16T3.. ISO | TCM. 0602.. ISO | TCM. 0902.. ISO | TCM. 1102.. ISO | |
|--------------------------|---|---|---|---|--|---|---|-----------------------------------|
| | |  |  |  |  |  |  | |
| Size (mm) | | Ø10 - Ø12 | Ø10 - Ø20 | Ø16 - Ø40 | Ø10 | Ø10 - Ø12 | Ø10 - Ø20 | |
| ISO Code | | STUC R/L | STUC R/L | STUC R/L | STFC R/L | STFC R/L | STFC R/L | |
| Cutting Angle | | 93° | 93° | 93° | 90° | 90° | 90° | |
| Clamping Type | T System |  | - | - | - | - | - | |
| | Page | | | | | | | |
| | P System |  | - | - | - | - | - | |
| | Page | | | | | | | |
| | S System |  | ✓ Size Range (mm) Ø10 - Ø12 | ✓ Size Range (mm) Ø10 - Ø20 | ✓ Size Range (mm) Ø16 - Ø40 | ✓ Size Range (mm) Ø10 | ✓ Size Range (mm) Ø10 - Ø12 | ✓ Size Range (mm) Ø10 - Ø20 |
| | Page | | B70 | B70 | B70 | B71 | B71 | B71 |
| | A System (inner hole) |  | - | - | - | - | - | - |
| | Page | | | | | | | |
| E System (Carbide Shank) |  | ✓ Size Range (mm) Ø10 - Ø12 | ✓ Size Range (mm) Ø12 - Ø16 | - | - | - | - | |
| Page | | B70 | B70 | | | | | |

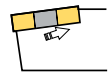
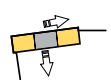
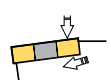
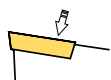
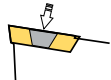
| Insert | | TCM. 16T3.. ISO | TCM. 0902.. ISO | TCM. 1102.. ISO | TCM. 16T3.. ISO | WCM. 0303.. ISO | |
|-----------------|---|---|---|---|---|---|--|
| | |  |  |  |  |  | |
| Size (mm) | | Ø16 - Ø40 | Ø12 | Ø12 - Ø20 | Ø16 - Ø40 | Ø08 - Ø10 | |
| ISO Code | | STFC R/L | ST-C R/L | ST-C R/L | ST-C R/L | SWLC R/L | |
| Cutting Angle | | 90° | 60° | 60° | 60° | 95° | |
| Clamping Type | T System |  | - | - | - | - | |
| | Page | | | | | | |
| | P System |  | - | - | - | - | |
| | Page | | | | | | |
| | M System |  | - | - | - | - | |
| | Page | | | | | | |
| | C System |  | - | - | - | - | |
| | Page | | | | | | |
| S System |  | ✓ Size Range (mm) Ø16- Ø40 | ✓ Size Range (mm) Ø12 | ✓ Size Range (mm) Ø12- Ø20 | ✓ Size Range (mm) Ø16 - Ø40 | ✓ Size Range (mm) Ø08 - Ø10 | |
| Page | | B71 | B71 | B71 | B71 | B71 | |



| Ordering Code | | Item Designation | Price | Master Insert* |
|------------------|-------------|----------------------|-------------|----------------|
| <i>Direction</i> | | TDUN R/L (93) | <i>EURO</i> | |
| <i>Right</i> | <i>Left</i> | | | |
| SM04887 | SM04924 | S25S TDUN R/L-11 | 68 € | DNM.1104.. |
| SM04917 | SM04955 | S32T TDUN R/L-11 | 86 € | |
| SM05044 | SM04986 | S25S TDUN R/L-15 | 72 € | DNM.1506.. |
| SM05075 | SM04993 | S32T TDUN R/L-15 | 98 € | |
| SM05099 | SM05013 | S40U TDUN R/L-15 | 120 € | |
| SM05112 | SM05174 | S50V TDUN R/L-15 | 150 € | |



| Ordering Code | | Item Designation | Price | Master Insert* |
|------------------|-------------|-------------------------|-------------|----------------|
| <i>Direction</i> | | TDQN R/L (107.5) | <i>EURO</i> | |
| <i>Right</i> | <i>Left</i> | | | |
| SM04894 | SM04931 | S25S TDQN R/L-11 | 68 € | DNM.1104.. |
| SM04962 | SM04979 | S32T TDQN R/L-11 | 86 € | |
| SM05051 | SM05136 | S25S TDQN R/L-15 | 72 € | DNM.1506.. |
| SM05082 | SM05006 | S32T TDQN R/L-15 | 98 € | |
| SM05105 | SM05150 | S40U TDQN R/L-15 | 120 € | |
| SM05020 | SM05181 | S50V TDQN R/L-15 | 150 € | |



| Ordering Code | | Item Designation | Price | Master Insert* |
|------------------|-------------|------------------------|-------------|----------------|
| <i>Direction</i> | | TD-N R/L (62.5) | <i>EURO</i> | |
| <i>Right</i> | <i>Left</i> | | | |
| SM04900 | SM04948 | S25S TD-N R/L-11 | 68 € | DNM.1104.. |
| SM05068 | SM05143 | S32T TD-N R/L-15 | 98 € | |
| SM05129 | SM05167 | S40U TD-N R/L-15 | 120 € | DNM.1506.. |
| SM05037 | SM05198 | S50V TD-N R/L-15 | 150 € | |

| Size Designation | Master Insert* | Spare Parts | | | | | |
|------------------|----------------|-------------|-------|------|------------|-------|-----------|
| | | Clamp | Screw | Shim | Shim Screw | Stamp | Allen Key |
| S25.. | DNM.1104.. | | | | | | |
| S32.. | | | | | | | |
| S25.. - S50.. | DNM.1506.. | | | | | | |



| Ordering Code | | Item Designation | Price | Master Insert* |
|------------------|-------------|----------------------|-------------|----------------|
| <i>Direction</i> | | TWLN R/L (95) | <i>EURO</i> | |
| <i>Right</i> | <i>Left</i> | | | |
| SM50471 | SM50488 | S20R TWLN R/L-06 | 69 € | WNM.0604.. |
| SM05488 | SM05495 | S25S TWLN R/L-06 | 72 € | |
| SM05518 | SM05501 | S32T TWLN R/L-06 | 86 € | WNM.0804.. |
| SM05532 | SM05570 | S25S TWLN R/L-08 | 72 € | |
| SM05549 | SM05525 | S32T TWLN R/L-08 | 98 € | |
| SM05556 | SM05587 | S40U TWLN R/L-08 | 120 € | |
| SM05563 | SM05594 | S50V TWLN R/L-08 | 150 € | |

| Size Designation | Master Insert* | Spare Parts | | | | | |
|------------------|----------------|-----------------|-----------------|----------------|-----------------|-------|--------------|
| | | Clamp | Screw | Shim | Shim Screw | Stamp | Allen Key |
| S20.. | WNM.0604.. | | | | | | SAK-AA3-9902 |
| S25.. - S32.. | | TSK7-9125 | TSBV M5x18-9201 | - | - | - | |
| S25.. - S50.. | WNM.0804.. | | | | | | SAK-AA3-9902 |
| | TSK2-9102 | TSBV M5x24-9202 | BAX WN06-9606 | CSAV M3x8-9401 | TSP 6.5x12-9705 | | |
| | | TSK1-9101 | TSBV M6x30-9205 | BAX WN08-9607 | TSAV M4x10-9403 | | |



| Ordering Code | | Item Designation | Price | Master Insert* |
|------------------|-------------|----------------------|-------------|----------------|
| <i>Direction</i> | | TCLN R/L (95) | <i>EURO</i> | |
| <i>Right</i> | <i>Left</i> | | | |
| SM38721 | SM38714 | S20R TCLN R/L-12 | 65 € | CNM.1204.. |
| SM04764 | SM04740 | S25S TCLN R/L-12 | 72 € | |
| SM04832 | SM04757 | S32T TCLN R/L-12 | 98 € | |
| SM04788 | SM04795 | S40U TCLN R/L-12 | 120 € | |
| SM04771 | SM04801 | S50V TCLN R/L-12 | 150 € | |
| SM04818 | SM04825 | S32T TCLN R/L-16 | 105 € | CNM.1606.. |
| SM04849 | SM04863 | S40U TCLN R/L-16 | 134 € | |
| SM04856 | SM04870 | S50V TCLN R/L-16 | 165 € | CNM..1909.. |
| SM49314 | SM49321 | S40U TCLN R/L-19 | 150 € | |
| SM38875 | SM38868 | S50V TCLN R/L-19 | 179 € | |

| Size Designation | Master Insert* | Spare Parts | | | | | |
|------------------|----------------|-------------|-------------------|---------------|--------------------|-----------------|--------------|
| | | Clamp | Screw | Shim | Shim Screw | Stamp | Allen Key |
| S20.. | CNM.1204.. | | | | | | SAK-AA3-9902 |
| S25.. - S50.. | | TSK6-9106 | TSBV M5x18-9201 | - | - | - | |
| S32.. - S50.. | CNM.1606.. | | | | | | SAK-AA4-9903 |
| S40.. - S50 | CNM.1909.. | TSK1-9101 | TSBV M6x30-9205 | BAX CN12-9603 | TSAV M4x10-9403 | TSP 6.5x12-9705 | |
| | | TSK3-9103 | TSBV M6x30x7-9206 | BAX CN16-9604 | TSAV M6x16x9-9404 | | |
| | | TSK4-9104 | TSBV M8x30-9207 | BAX CN19-9605 | TSAV M6x16x11-9406 | | |

*Suitable Insert is ISO

**Spare Parts Ordering Codes

T System Internal Lathe Tool Holders



| Ordering Code | | Item Designation | Price | Master Insert* |
|---------------|---------|----------------------|-------|----------------|
| Direction | | <i>TSKN R/L (75)</i> | EURO | |
| Right | Left | | | |
| SM05204 | SM05235 | S25S TSKN R/L-12 | 72 € | SNM.1204.. |
| SM05211 | SM05242 | S32T TSKN R/L-12 | 98 € | |
| SM05228 | SM05259 | S40U TSKN R/L-12 | 120 € | |
| SM05266 | SM05273 | S50V TSKN R/L-12 | 150 € | |
| SM37601 | SM37618 | S32T TSKN R/L-15 | 105 € | SNM.1506 |
| SM37625 | SM37632 | S40U TSKN R/L-15 | 134 € | |
| SM37649 | SM37656 | S50V TSKN R/L-15 | 165 € | |

| Size Designation | Master Insert* | Spare Parts | | | | | |
|------------------|----------------|-------------|----------------------|------------------|----------------------|--------------------|------------------|
| | | Clamp | Screw | Shim | Shim Screw | Stamp | Allen Key |
| S25.. - S50.. | SNM.1204.. | | | | | | |
| | | TSK1-9101 | TSBV M6x30-9205 | BAX SN12-9608 | TSAV M4x10-9403 | TSP 6.5x12-9705 | SAK- AA3-9902 |
| S32.. - S50.. | SNM.1506.. | TSK3-9103 | TSBV M6x30x7-9206 | BAX SN15-9609 | TSAV M6x16x9-9404 | - | |



| Ordering Code | | Item Designation | Price | Master Insert* |
|---------------|---------|----------------------|-------|----------------|
| Direction | | <i>TVUN R/L (93)</i> | EURO | |
| Right | Left | | | |
| SM05426 | SM05433 | S25S TVUN R/L-16 | 72 € | VNM.1604.. |
| SM05440 | SM05457 | S32T TVUN R/L-16 | 98 € | |
| SM05464 | SM05471 | S40U TVUN R/L-16 | 120 € | |
| SM49338 | SM49345 | S50V TVUN R/L-16 | 150 € | |

| Size Designation | Master Insert* | Spare Parts | | | | | |
|------------------|----------------|-------------|--------------------|------------------|-------------------------|--------------------|------------------|
| | | Clamp | Screw | Shim | Shim Screw | Stamp | Allen Key |
| S25.. | VNM.1604.. | | | | | | |
| S32.. - S50 | | TSK2-9102 | TSBV M5x24-9202 | BAX VN16-9612 | TSAV M4x10x6 9402 | - | SAK- AA3-9902 |
| | | TSK5-9105 | TSBV M6x30-9205 | | | TSP 6.5x12-9705 | |



| Ordering Code | | Item Designation | Price | Master Insert* |
|---------------|---------|----------------------|-------|----------------|
| Direction | | <i>TTUN R/L (93)</i> | EURO | |
| Right | Left | | | |
| SM05280 | SM05297 | S25S TTUN R/L-16 | 72 € | TNM.1604.. |
| SM05327 | SM05334 | S32T TTUN R/L-16 | 98 € | |
| SM05365 | SM05372 | S32T TTUN R/L-22 | 105 € | TNM.2204.. |
| SM05389 | SM05396 | S40U TTUN R/L-22 | 120 € | |
| SM05402 | SM05419 | S50V TTUN R/L-22 | 165 € | |



| Ordering Code | | Item Designation | Price | Master Insert* |
|---------------|---------|----------------------|-------|----------------|
| Direction | | <i>TT-N R/L (60)</i> | EURO | |
| Right | Left | | | |
| SM05303 | SM05310 | S25S TT-N R/L-16 | 72 € | TNM.1604.. |
| SM05341 | SM05358 | S32T TT-N R/L-16 | 98 € | |



| Ordering Code | | Item Designation | Price | Master Insert* |
|------------------|-------------|------------------------|-------------|---|
| <i>Direction</i> | | A-PDUN R/L (93) | EURO |  |
| <i>Right</i> | <i>Left</i> | | | |
| SM40328 | SM40335 | A32S PDUN R/L-15 | 112 € | DNM.1506.. |



| Ordering Code | | Item Designation | Price | Master Insert* |
|------------------|-------------|----------------------|-------------|---|
| <i>Direction</i> | | PDUN R/L (93) | EURO |  |
| <i>Right</i> | <i>Left</i> | | | |
| SM06072 | SM06089 | S32T PDUN R/L-15 | 94 € | DNM.1506.. |
| SM06119 | SM06126 | S40U PDUN R/L-15 | 120 € | |
| SM37663 | SM37670 | S50V PDUN R/L-15 | 150 € | |



| Ordering Code | | Item Designation | Price | Master Insert* |
|------------------|-------------|---------------------------|-------------|---|
| <i>Direction</i> | | A-PDQN R/L (107.5) | EURO |  |
| <i>Right</i> | <i>Left</i> | | | |
| SM40366 | SM40373 | A25R PDQN R/L-15 | 83 € | DNM.1506.. |
| SM40359 | SM40342 | A32S PDQN R/L-15 | 112 € | |



| Ordering Code | | Item Designation | Price | Master Insert* |
|------------------|-------------|-------------------------|-------------|---|
| <i>Direction</i> | | PDQN R/L (107.5) | EURO |  |
| <i>Right</i> | <i>Left</i> | | | |
| SM06065 | SM27770 | S25S PDQN R/L-15 | 72 € | DNM.1506.. |
| SM06102 | SM06096 | S32T PDQN R/L-15 | 94 € | |
| SM06133 | SM06140 | S40U PDQN R/L-15 | 120 € | |
| SM37687 | SM38660 | S50V PDQN R/L-15 | 150 € | |

| Size Designation | Master Insert* | Spare Parts | | | | |
|------------------|----------------|---|---|--|---|---|
| | | Lever | Lever Screw | Shim | Shim Spring | Allen Key |
| S25.. | DNM.1506.. |  |  |  |  |  |
| S32.. - S50.. | | SPL4-9123 | SLV5 M8x19-9231 SLV2 M8x21-9225 | BAX DN15-9602 | SLAY1-9701 | SAK-AA3-9902 |

*Suitable Insert is ISO







**Spare Parts Ordering Codes



| Ordering Code | | Item Designation | Price | Master Insert* |
|------------------|-------------|------------------------|-------------|---|
| <i>Direction</i> | | A-PCLN R/L (95) | EURO |  |
| <i>Right</i> | <i>Left</i> | | | |
| SM40403 | SM40410 | A25R PCLN R/L-12 | 83 € | CNM.1204.. |
| SM40304 | SM40311 | A32S PCLN R/L-12 | 112 € | |
| SM49352 | SM49369 | A32S PCLN R/L-16 | 120 € | CNM.1606.. |









| Ordering Code | | Item Designation | Price | Master Insert* |
|------------------|-------------|----------------------|-------------|---|
| <i>Direction</i> | | PCLN R/L (95) | EURO |  |
| <i>Right</i> | <i>Left</i> | | | |
| SM05938 | SM05945 | S25S PCLN R/L-12 | 72 € | CNM.1204.. |
| SM05952 | SM05969 | S32T PCLN R/L-12 | 94 € | |
| SM05976 | SM05983 | S40U PCLN R/L-12 | 120 € | CNM.1606.. |
| SM05990 | SM06003 | S32T PCLN R/L-16 | 105 € | |
| SM06010 | SM06027 | S40U PCLN R/L-16 | 134 € | CNM.1906.. |
| SM37694 | SM37700 | S50V PCLN R/L-16 | 165 € | |
| SM37717 | SM37724 | S40U PCLN R/L-19 | 150 € | CNM.1906.. |
| SM37731 | SM37748 | S50V PCLN R/L-19 | 179 € | |

| Size Designation | Master Insert* | Spare Parts | | | | |
|------------------|---|---|---|--|---|---|
| |  | | <i>Lever</i> | <i>Lever Screw</i> | <i>Shim</i> | <i>Shim Spring</i> |
| S25.. - S40.. | CNM.1204.. |  |  |  |  |  |
| S32.. - S50.. | CNM.1606.. | SPL1-9120 | SLV1 M8x20-9224 | BAX CN12-9603 | SLAY1 -9701 | SAK-AA3-9902 |
| S40.. - S50.. | CNM.1906.. | SPL2-9121 | SLV2 M8x24 -9225 | BAX CN16-9604 | SLAY2 -9702 | |
| | | SPL3-9122 | SLV3 M10x29-9226 | BAX CN19 -9605 | SLAY3 -9703 | SAK-AA4-9903 |







| Ordering Code | | Item Designation | Price | Master Insert* |
|------------------|-------------|------------------------|-------------|---|
| <i>Direction</i> | | A-PSKN R/L (75) | EURO |  |
| <i>Right</i> | <i>Left</i> | | | |
| SM49376 | SM49383 | A25R PSKN R/L-12 | 83 € | SNM.1204.. |
| SM49390 | SM49406 | A32S PSKN R/L-12 | 112 € | |
| SM49413 | SM49420 | A32S PSKN R/L-15 | 120 € | SNM.1506.. |

| Size Designation | Master Insert* | Spare Parts | | | | |
|------------------|---|---|---|--|---|---|
| |  | | <i>Lever</i> | <i>Lever Screw</i> | <i>Shim</i> | <i>Shim Spring</i> |
| S25.. - S40.. | SNM.1204.. |  |  |  |  |  |
| S32.. - S50.. | SNM.1506.. | SPL1-9120 | SLV1 M8x20-9224 | BAX SN12-9608 | SLAY1 -9701 | SAK-AA3-9902 |
| | | SPL2-9121 | SLV2 M8x24-9225 | BAX SN15-9609 | SLAY2 -9702 | |



| Ordering Code | | Item Designation | Price | Master Insert* |
|------------------|-------------|----------------------|-------------|---|
| <i>Direction</i> | | PSKN R/L (75) | <i>EURO</i> |  |
| <i>Right</i> | <i>Left</i> | | | |
| SM06157 | SM06164 | S25S PSKN R/L-12 | 72 € | SNM.1204.. |
| SM06171 | SM06188 | S32T PSKN R/L-12 | 94 € | |
| SM06195 | SM06201 | S40U PSKN R/L-12 | 120 € | |
| SM06218 | SM06225 | S32T PSKN R/L-15 | 105 € | SNM.1506.. |
| SM06232 | SM06249 | S40U PSKN R/L-15 | 134 € | |
| SM37779 | SM37786 | S50V PSKN R/L-15 | 165 € | |

| Size Designation | Master Insert* | Spare Parts | | | | |
|------------------|---|--|---|--|--|------------------|
| |  | <i>Lever</i> | <i>Lever Screw</i> | <i>Shim</i> | <i>Shim Spring</i> | <i>Allen Key</i> |
| S25.. - S40.. | SNM.1204.. |  SPL1-9120 |  SLV1 M8x20-9224 |  BAX SN12-9608 |  SLAY1 -9701 | SAK-AA3-9902 |
| S32.. - S50.. | SNM.1506.. |  SPL2-9121 |  SLV2 M8x24-9225 |  BAX SN15-9609 |  SLAY2 -9702 | |



| Ordering Code | | Item Designation | Price | Master Insert* |
|------------------|-------------|------------------------|-------------|---|
| <i>Direction</i> | | A-PWLN R/L (95) | <i>EURO</i> |  |
| <i>Right</i> | <i>Left</i> | | | |
| SM40250 | SM40267 | A25R PWLN R/L-08 | 83 € | WNM.0804.. |
| SM40236 | SM40243 | A32S PWLN R/L-08 | 112 € | |



| Ordering Code | | Item Designation | Price | Master Insert* |
|------------------|-------------|----------------------|-------------|---|
| <i>Direction</i> | | PWLN R/L (95) | <i>EURO</i> |  |
| <i>Right</i> | <i>Left</i> | | | |
| SM06256 | SM06263 | S25S PWLN R/L-08 | 72 € | WNM.0804.. |
| SM06270 | SM06287 | S32T PWLN R/L-08 | 94 € | |
| SM06294 | SM06300 | S40U PWLN R/L-08 | 120 € | |
| SM37755 | SM37762 | S50V PWLN R/L-08 | 150 € | |

| Size Designation | Master Insert* | Spare Parts | | | | |
|------------------|---|--|---|--|--|------------------|
| |  | <i>Lever</i> | <i>Lever Screw</i> | <i>Shim</i> | <i>Shim Spring</i> | <i>Allen Key</i> |
| S25.. - S50.. | WNM.0804.. |  SPL1-9120 |  SLV1 M8x20-9224 |  BAX WN08-9607 |  SLAY1 -9701 | SAK-AA3-9902 |

*Suitable Insert is ISO
**Spare Parts Ordering Codes



| Ordering Code | | Item Designation | Price | Master Insert* |
|------------------|-------------|----------------------|-------------|----------------|
| <i>Direction</i> | | MTUN R/L (93) | <i>EURO</i> | |
| <i>Right</i> | <i>Left</i> | | | |
| SM22072 | SM23529 | S20R MTUN R/L-16 | 64 € | TNM.1604.. |
| SM23536 | SM23567 | S25S MTUN R/L-16 | 73 € | |
| SM20870 | SM20887 | S32T MTUN R/L-16 | 95 € | |
| SM20979 | SM20986 | S40U MTUN R/L-16 | 117 € | |
| SM05648 | SM05648 | S32T MTUN R/L-22 | 95 € | TNM.2204.. |
| SM05679 | SM05679 | S40U MTUN R/L-22 | 117 € | |
| SM05709 | SM05709 | S50V MTUN R/L-22 | 144 € | |



| Ordering Code | | Item Designation | Price | Master Insert* |
|------------------|-------------|-------------------------|-------------|----------------|
| <i>Direction</i> | | MTQN R/L (107.5) | <i>EURO</i> | |
| <i>Right</i> | <i>Left</i> | | | |
| SM22188 | SM22195 | S20R MTQN R/L-16 | 64 € | TNM.1604.. |
| SM23543 | SM23550 | S25S MTQN R/L-16 | 73 € | |
| SM20665 | SM20894 | S32T MTQN R/L-16 | 95 € | |
| SM22362 | SM22355 | S40U MTQN R/L-16 | 117 € | |
| SM05655 | SM05723 | S32T MTQN R/L-22 | 95 € | TNM.2204.. |
| SM05686 | SM05730 | S40U MTQN R/L-22 | 117 € | |
| SM05631 | SM05761 | S50V MTQN R/L-22 | 144 € | |















| Ordering Code | | Item Designation | Price | Master Insert* |
|------------------|-------------|----------------------|-------------|----------------|
| <i>Direction</i> | | MT-N R/L (60) | <i>EURO</i> | |
| <i>Right</i> | <i>Left</i> | | | |
| SM23642 | SM23659 | S25S MT-N R/L-16 | 73 € | TNM.1604.. |
| SM23673 | SM23666 | S32T MT-N R/L-16 | 95 € | |
| SM22379 | SM05600 | S40U MT-N R/L-16 | 117 € | |
| SM05662 | SM05617 | S32T MT-N R/L-22 | 95 € | TNM.2204.. |
| SM05693 | SM05747 | S40U MT-N R/L-22 | 117 € | |
| SM05778 | SM05785 | S50V MT-N R/L-22 | 144 € | |

| Size Designation | Master Insert* | Spare Parts | | | | | |
|------------------|----------------|-------------|-----------------|---------------|---------------------|-----------------|--------------|
| | | Clamp | Screw | Shim | Pin | Stamp | Allen Key |
| S20.. | | | | | | | |
| S25.. | | | | | | | |
| S32.. - S40.. | TNM.1604.. | MSK2-9108 | TSBV M5x18-9201 | - | BMP4 3.70x5x12 9322 | - | SAK-AA3-9902 |
| S32.. - S50.. | TNM.2204.. | MSK1-9107 | TSBV M6x27 9203 | BAX TN16-9610 | BMP1 3.70x5x17-9309 | TSP 6.5x12-9705 | |
| | | | TSBV M6x30-9205 | BAX TN22-9611 | BMP2 5x6x16-9310 | | |









| Ordering Code | | Item Designation | Price | Master Insert* |
|------------------|-------------|----------------------|-------------|---|
| <i>Direction</i> | | MWLN R/L (95) | EURO |  |
| <i>Right</i> | <i>Left</i> | | | |
| SM05792 | SM05815 | S16P MWLN R/L-06 | 58 € | WNM.0604.. |
| SM05808 | SM05822 | S20R MWLN R/L-06 | 64 € | |
| SM05860 | SM05839 | S25S MWLN R/L-06 | 69 € | |
| SM05853 | SM05891 | S25S MWLN R/L-08 | 73 € | WNM.0804.. |
| SM05877 | SM05907 | S32T MWLN R/L-08 | 95 € | |
| SM05884 | SM05914 | S40U MWLN R/L-08 | 117 € | |
| SM05846 | SM05921 | S50V MWLN R/L-08 | 144 € | |

C System Internal Lathe Tool Holders

| Size Designation | Master Insert* | Spare Parts | | | | | |
|------------------|---|---|---|---|---|---|---|
| |  | <i>Clamp</i> | <i>Screw</i> | <i>Shim</i> | <i>Pin</i> | <i>Stamp</i> | <i>Allen Key</i> |
| S16.. | WNM.0604.. |  |  |  |  |  |  |
| S20.. | | | | | | | |
| S25.. | | | | | | | |
| S25.. | WNM.0804.. |  |  |  |  |  |  |
| S32.. - S50.. | | | | | | | |



| Ordering Code | | Item Designation | Price | Master Insert* |
|------------------|-------------|----------------------|-------------|---|
| <i>Direction</i> | | CKUN R/L (93) | EURO |  |
| <i>Right</i> | <i>Left</i> | | | |
| SM20771 | SM20788 | S25S CKUN R/L-16 | 54 € | KNUX- R/L 1604.. |
| SM20818 | SM20825 | S32T CKUN R/L-16 | 72 € | |
| SM20832 | SM20849 | S40U CKUN R/L-16 | 111 € | |
| SM20856 | SM20863 | S50V CKUN R/L-16 | 150 € | |

| Size Designation | Master Insert* | Spare Parts | | | | |
|------------------|---|---|---|--|---|---|
| |  | <i>Clamp</i> | <i>Screw</i> | <i>Shim</i> | <i>Shim Screw</i> | <i>Allen Key</i> |
| S25.. | KNUX-R/L 1604.. |  |  |  |  |  |
| S32.. - S50.. | | | | | | |

*Suitable Insert is ISO
**Spare Parts Ordering Codes



| Ordering Code | | Item Designation | Price | Master Insert* |
|------------------|-------------|-----------------------|--------------|----------------|
| <i>Direction</i> | | <i>E-SDUC R/L(93)</i> | EURO | |
| <i>Right</i> | <i>Left</i> | | | |
| SM59771 | SM59818 | E10M SDUC R/L-07 | 175 € | DCM. 0702.. |
| SM59788 | SM59825 | E12Q SDUC R/L-07 | 253 € | |
| SM59795 | SM59832 | E16R SDUC R/L-11 | 295 € | DCM. 11T3.. |
| SM59801 | SM59849 | E20S SDUC R/L-11 | 560 € | |



| Ordering Code | | Item Designation | Price | Master Insert* |
|------------------|-------------|---------------------------|--------------|----------------|
| <i>Direction</i> | | <i>E-SDUC R/L(93) SET</i> | EURO | |
| <i>Right</i> | <i>Left</i> | | | |
| SM59870 | SM59887 | E10M SDUC R/L-07 | 721 € | DCM. 0702.. |
| | | E12Q SDUC R/L-07 | | |
| | | E16R SDUC R/L-11 | | DCM. 11T3.. |

| Size Designation | Master Insert* | Spare Parts | | | |
|------------------|----------------|-------------------------|------|------------|--------------|
| | | Screw | Shim | Shim Screw | Torx Key |
| E10.. - E12 | DCM. 0702.. | SSV M2.5x6-9505 | | | STK-T08-9908 |
| E16.. - E20.. | DCM. 11T3.. | SSV M3.5x10-9511 | - | | |



| Ordering Code | | Item Designation | Price | Master Insert* |
|------------------|-------------|-----------------------|-------------|----------------|
| <i>Direction</i> | | <i>A-SDUC R/L(93)</i> | EURO | |
| <i>Right</i> | <i>Left</i> | | | |
| SM36093 | SM36109 | A10H SDUC R/L-07 | 36 € | DCM. 0702.. |
| SM36116 | SM36123 | A12H SDUC R/L-07 | 40 € | |
| SM36130 | SM36147 | A16M SDUC R/L-07 | 45 € | DCM. 11T3.. |
| SM36154 | SM36161 | A16M SDUC R/L-11 | 46 € | |
| SM36178 | SM36185 | A20P SDUC R/L-11 | 50 € | |
| SM36192 | SM36208 | A25R SDUC R/L-11 | 57 € | |
| SM36215 | SM36222 | A32S SDUC R/L-11 | 90 € | |









| Ordering Code | | Item Designation | Price | Master Insert* |
|------------------|-------------|---------------------------|-------------|----------------|
| <i>Direction</i> | | <i>A-SDUC R/L(93) SET</i> | EURO | |
| <i>Right</i> | <i>Left</i> | | | |
| SM59856 | SM59863 | A10H SDUC R/L-07 | 130 € | DCM. 0702.. |
| | | A12H SDUC R/L-07 | | |
| | | A16M SDUC R/L-11 | | DCM. 11T3.. |



| Ordering Code | | Item Designation | Price | Master Insert* |
|------------------|-------------|---------------------|-------------|---|
| <i>Direction</i> | | SDUC R/L(93) | <i>EURO</i> |  |
| <i>Right</i> | <i>Left</i> | | | |
| SM06713 | SM06805 | S10K SDUC R/L-07 | 29 € | DCM. 0702.. |
| SM06744 | SM06775 | S12K SDUC R/L-07 | 32 € | |
| SM06850 | SM06935 | S16x10M SDUC R/L-07 | 43 € | |
| SM06874 | SM06959 | S16x12M SDUC R/L-07 | 43 € | |
| SM06836 | SM06904 | S16P SDUC R/L-07 | 36 € | |
| SM42803 | SM42810 | S20R SDUC R/L-07 | 40 € | |
| SM07017 | SM07055 | S16P SDUC R/L-11 | 36 € | DCM. 11T3.. |
| SM07086 | SM07116 | S20R SDUC R/L-11 | 40 € | |
| SM07147 | SM07178 | S25S SDUC R/L-11 | 47 € | |
| SM39629 | SM39636 | S25S SDUC R/L-11S | 50 € | |
| SM07253 | SM07208 | S32T SDUC R/L-11 | 78 € | |
| SM07352 | SM07369 | S40U SDUC R/L-11 | 90 € | |



| Ordering Code | | Item Designation | Price | Master Insert* |
|------------------|-------------|-----------------------------|-------------|---|
| <i>Direction</i> | | SDUC R/L(93) SET | <i>EURO</i> |  |
| <i>Right</i> | <i>Left</i> | | | |
| SM59894 | SM59900 | S10K SDUC R/L-07 | 116 € | DCM. 0702.. |
| | | S12K SDUC R/L-07 | | DCM. 11T3.. |
| | | S16P SDUC R/L-11 | | |

| Size Designation | Master Insert* | Spare Parts | | | |
|------------------|--|---|--|--|---|
| | | Screw | Shim | Shim Screw | Torx Key |
| A10.. - A20 |  DCM. 0702.. |  SSV M2.5x6-9505 |  - |  - |  STK-T08-9908 |
| A16.. - A20.. | DCM. 11T3.. | SSV M3.5x10-9511 | BAX DC11-9613 | SBV5 M5x0.5 A3.5x9-9408 | STK-T15-9910 |
| A25.. | | SSV M3.5x14-9512 | | SBV M5x0.5 A3.5x11-9407 | |
| A32.. | | | | | |

S System Internal
Lathe Tool Holders





*Suitable Insert is ISO
**Spare Parts Ordering Codes



| Ordering Code | | Item Designation | Price | Master Insert* |
|------------------|-------------|--------------------------|--------------|---|
| <i>Direction</i> | | E-SDQC R/L(107.5) | EURO |  |
| <i>Right</i> | <i>Left</i> | | | |
| SM59979 | SM60012 | E10M SDQC R/L-07 | 175 € | DCM. 0702.. |
| SM59986 | SM60029 | E12Q SDQC R/L-07 | 253 € | |
| SM59993 | SM60036 | E16R SDQC R/L-11 | 295 € | DCM. 11T3.. |
| SM60005 | SM60043 | E20S SDQC R/L-11 | 560 € | |



| Ordering Code | | Item Designation | Price | Master Insert* |
|------------------|-------------|------------------------------|--------------|---|
| <i>Direction</i> | | E-SDQC R/L(107.5) SET | EURO |  |
| <i>Right</i> | <i>Left</i> | | | |
| SM59931 | SM59948 | E10M SDQC R/L-07 | 721 € | DCM. 0702.. |
| | | E12Q SDQC R/L-07 | | |
| | | E16R SDQC R/L-11 | | DCM. 11T3.. |

| Size Designation | Master Insert* | Spare Parts | | | |
|------------------|--|---|---|---|--|
| | | Screw | Shim | Shim Screw | Torx Key |
| E10.. - E12 |  DCM. 0702.. |  SSV M2.5x6- 9505 |  |  |  STK-T08-9908 |
| E16.. - E20.. | DCM. 11T3.. | SSV M3.5x10- 9511 | - | - | STK-T15-9910 |



| Ordering Code | | Item Designation | Price | Master Insert* |
|------------------|-------------|--------------------------|-------------|---|
| <i>Direction</i> | | A-SDQC R/L(107.5) | EURO |  |
| <i>Right</i> | <i>Left</i> | | | |
| SM36239 | SM36246 | A10H SDQC R/L-07 | 36 € | DCM. 0702.. |
| SM36253 | SM36260 | A12H SDQC R/L-07 | 40 € | |
| SM36277 | SM36284 | A16M SDQC R/L-07 | 45 € | DCM. 11T3.. |
| SM36291 | SM36307 | A16M SDQC R/L-11 | 46 € | |
| SM36314 | SM36321 | A20P SDQC R/L-11 | 50 € | |
| SM36338 | SM36345 | A25R SDQC R/L-11 | 57 € | |
| SM36352 | SM36369 | A32S SDQC R/L-11 | 90 € | |



| Ordering Code | | Item Designation | Price | Master Insert* |
|------------------|-------------|------------------------------|-------------|---|
| <i>Direction</i> | | A-SDQC R/L(107.5) SET | EURO |  |
| <i>Right</i> | <i>Left</i> | | | |
| SM59917 | SM59924 | A10H SDQC R/L-07 | 130 € | DCM. 0702.. |
| | | A12H SDQC R/L-07 | | |
| | | A16M SDQC R/L-11 | | DCM. 11T3.. |







| Ordering Code | | Item Designation | Price | Master Insert* |
|------------------|-------------|------------------------|-------------|---|
| <i>Direction</i> | | SDQC R/L(107.5) | <i>EURO</i> |  |
| <i>Right</i> | <i>Left</i> | | | |
| SM06720 | SM06737 | S10K SDQC R/L-07 | 29 € | DCM. 0702.. |
| SM06751 | SM06799 | S12K SDQC R/L-07 | 32 € | |
| SM06867 | SM06942 | S16x10M SDQC R/L-07 | 43 € | |
| SM06898 | SM06966 | S16x12M SDQC R/L-07 | 43 € | |
| SM06911 | SM06928 | S16P SDQC R/L-07 | 36 € | |
| SM49437 | SM49444 | S20R SDQC R/L-07 | 40 € | |
| SM07031 | SM07291 | S16P SDQC R/L-11 | 36 € | |
| SM07093 | SM07130 | S20R SDQC R/L-11 | 40 € | |
| SM07161 | SM07192 | S25S SDQC R/L-11 | 47 € | |
| SM39421 | SM39414 | S25S SDQC R/L-11S | 50 € | |
| SM07239 | SM07246 | S32T SDQC R/L-11 | 78 € | |
| SM07376 | SM07383 | S40U SDQC R/L-11 | 90 € | |



| Ordering Code | | Item Designation | Price | Master Insert* |
|------------------|-------------|----------------------------|-------------|---|
| <i>Direction</i> | | SDQC R/L(107.5) SET | <i>EURO</i> |  |
| <i>Right</i> | <i>Left</i> | | | |
| SM59955 | SM59962 | S10K SDQC R/L-07 | 116 € | DCM. 0702.. |
| | | S12K SDQC R/L-07 | | DCM. 11T3.. |
| | | S16P SDQC R/L-11 | | |

S System Internal Lathe Tool Holders

| Size Designation | Master Insert* | Spare Parts | | | |
|------------------|---|---|---|---|--------------|
| | | Screw | Shim | Shim Screw | Torx Key |
| S10.. - S20 |  DCM. 0702.. |  SSV M2.5x6-9505 |  - |  - | STK-T08-9908 |
| S16.. - S25.. | DCM. 11T3.. | SSV M3.5x10-9511 | BAX DC11-9613 | SBV5 M5x0.5 A3.5x9-9408 | STK-T15-9910 |
| S25(S).. | | SSV M3.5x14-9512 | | SBV M5x0.5 A3.5x11-9407 | |
| S32.. - S40.. | | | | | |

*Suitable Insert is ISO

**Spare Parts Ordering Codes



| Ordering Code | | Item Designation | Price | Master Insert* |
|------------------|-------------|------------------------|-------|----------------|
| <i>Direction</i> | | SDPC R/L(117.5) | EURO | |
| <i>Right</i> | <i>Left</i> | | | |
| SM06829 | SM06973 | S10K SDPC R/L-07 | 29 € | DCM. 0702.. |
| SM06843 | SM06980 | S12K SDPC R/L-07 | 32 € | |
| SM07314 | SM07390 | S16P SDPC R/L-11 | 36 € | DCM. 11T3.. |
| SM07338 | SM07406 | S20R SDPC R/L-11 | 40 € | |
| SM07345 | SM07413 | S25S SDPC R/L-11 | 47 € | |
| SM52086 | SM52093 | S25S SDPC R/L-11S | 50 € | |
| SM07277 | SM07437 | S32T SDPC R/L-11 | 78 € | |
| SM07475 | SM07482 | S40U SDPC R/L-11 | 90 € | |



| Ordering Code | | Item Designation | Price | Master Insert* |
|------------------|-------------|---------------------|-------|----------------|
| <i>Direction</i> | | SDXC R/L(93) | EURO | |
| <i>Right</i> | <i>Left</i> | | | |
| SM06768 | SM06997 | S12K SDXC R/L-07 | 32 € | DCM. 0702.. |
| SM07048 | SM07307 | S16P SDXC R/L-11 | 36 € | DCM. 11T3.. |
| SM07109 | SM07321 | S20R SDXC R/L-11 | 40 € | |
| SM07260 | SM07420 | S25S SDXC R/L-11 | 47 € | |
| SM07284 | SM07444 | S32T SDXC R/L-11 | 78 € | |
| SM07499 | SM07505 | S40U SDXC R/L-11 | 90 € | |



| Ordering Code | | Item Designation | Price | Master Insert* |
|------------------|-------------|----------------------|-------|----------------|
| <i>Direction</i> | | SD-CR/L(62.5) | EURO | |
| <i>Right</i> | <i>Left</i> | | | |
| SM42780 | SM42797 | S10K SD-CR/L-07 | 32 € | DCM. 0702.. |
| SM06812 | SM06782 | S12K SD-CR/L-07 | 32 € | |
| SM06881 | SM07000 | S16x12M SD-CR/L-07 | 43 € | DCM. 11T3.. |
| SM07024 | SM07062 | S16P SD-CR/L-11 | 36 € | |
| SM07079 | SM07123 | S20R SD-CR/L-11 | 40 € | |
| SM07154 | SM07185 | S25S SD-CR/L-11 | 47 € | |
| SM07215 | SM07222 | S32T SD-CR/L-11 | 78 € | |
| SM07451 | SM07468 | S40U SD-CR/L-11 | 90 € | |

| Size Designation | Master Insert* | Spare Parts | | | |
|------------------|-----------------|------------------------|------------------|----------------------------|--------------|
| | | Screw | Shim | Shim Screw | Torx Key |
| S10.. - S20 | DCM. 0702.. | SSV M2.5x6-9505 | | | STK-T08-9908 |
| S16.. - S25.. | DCM. 11T3.. | SSV M3.5x10-9511 | BAX DC11-9613 | SBV5 M5x0.5 A3.5x9-9408 | STK-T15-9910 |
| S25(S).. | | SSV M3.5x14-9512 | | SBV M5x0.5 A3.5x11-9407 | |
| S32.. - S40.. | | | | | |



| Ordering Code | | Item Designation | Price | Master Insert* |
|------------------|-------------|---------------------|-------------|---|
| <i>Direction</i> | | SVUB R/L(93) | <i>EURO</i> |  |
| <i>Right</i> | <i>Left</i> | | | |
| SM08298 | SM08328 | S16P SVUB R/L-11 | 43 € | VBM. 1103.. |
| SM08267 | SM08342 | S20R SVUB R/L-11 | 51 € | |
| SM08397 | SM08441 | S25S SVUB R/L-16 | 53 € | VBM. 1604.. |
| SM39933 | SM39971 | S25S SVUB R/L-16S | 51 € | |
| SM08410 | SM08472 | S32T SVUB R/L-16 | 78 € | |
| SM08502 | SM08519 | S40U SVUB R/L-16 | 90 € | |



| Ordering Code | | Item Designation | Price | Master Insert* |
|------------------|-------------|------------------------|-------------|---|
| <i>Direction</i> | | SVQB R/L(107.5) | <i>EURO</i> |  |
| <i>Right</i> | <i>Left</i> | | | |
| SM08304 | SM08366 | S16P SVQB R/L-11 | 43 € | VBM. 1103.. |
| SM08274 | SM08380 | S20R SVQB R/L-11 | 51 € | |
| SM08403 | SM08434 | S25S SVQB R/L-16 | 53 € | VBM. 1604.. |
| SM39926 | SM52055 | S25S SVQB R/L-16S | 51 € | |
| SM08465 | SM08458 | S32T SVQB R/L-16 | 78 € | |
| SM08595 | SM08601 | S40U SVQB R/L-16 | 90 € | |



| Ordering Code | | Item Designation | Price | Master Insert* |
|------------------|-------------|---------------------|-------------|---|
| <i>Direction</i> | | SVJB R/L(93) | <i>EURO</i> |  |
| <i>Right</i> | <i>Left</i> | | | |
| SM08533 | SM08540 | S25S SVJB R/L-16 | 53 € | VBM. 1604.. |
| SM49505 | SM49499 | S25S SVJB R/L-16S | 51 € | |
| SM08564 | SM08571 | S32T SVJB R/L-16 | 78 € | |
| SM08618 | SM08625 | S40U SVJB R/L-16 | 90 € | |





| Ordering Code | | Item Designation | Price | Master Insert* |
|------------------|-------------|---------------------|-------------|---|
| <i>Direction</i> | | SVXB R/L(52) | <i>EURO</i> |  |
| <i>Right</i> | <i>Left</i> | | | |
| SM08281 | SM08335 | S16P SVXB R/L-11 | 43 € | VBM. 1103.. |
| SM08311 | SM08359 | S20R SVXB R/L-11 | 51 € | |
| SM08427 | SM08489 | S25S SVXB R/L-16 | 53 € | VBM. 1604.. |
| SM39964 | SM39957 | S25S SVXB R/L-16S | 51 € | |
| SM08496 | SM08557 | S32T SVXB R/L-16 | 78 € | |
| SM08526 | SM08588 | S40U SVXB R/L-16 | 90 € | |

S System Internal Lathe Tool Holders

*Suitable Insert is ISO
**Spare Parts Ordering Codes



| Ordering Code | | Item Designation | Price | Master Insert* |
|------------------|-------------|----------------------|-------------|---|
| <i>Direction</i> | | SV-BR/L(72.5) | <i>EURO</i> |  |
| <i>Right</i> | <i>Left</i> | | | |
| SM34709 | SM34716 | S25S SV-BR/L-16 | 53 € | VBM. 1604.. |
| SM34723 | SM34730 | S32T SV-BR/L-16 | 78 € | |

| Size Designation | Master Insert* | Spare Parts | | | |
|------------------|---|-----------------------------|--------------------------|------------------------------------|--------------|
| |  | Screw | Shim | Shim Screw | Torx Key |
| S16.. - S20 | VBM. 1103.. | SSV M2.5x6- 9505 | - | | STK-T08-9908 |
| S25.. | VBM. 1604.. | SSV M3.5x10- 9511 | BAX VB16- 9618 | SBV5 M5x0.5 A3.5x9- 9408 | STK-T15-9910 |
| S25(S).. | | SSV M3.5x14- 9512 | | SBV M5x0.5 A3.5x11- 9407 | |
| S32.. - S40.. | | | | | |



| Ordering Code | | Item Designation | Price | Master Insert* |
|------------------|-------------|---------------------|-------------|---|
| <i>Direction</i> | | SVUC R/L(93) | <i>EURO</i> |  |
| <i>Right</i> | <i>Left</i> | | | |
| SM08373 | SM08632 | S16P SVUC R/L-11 | 43 € | VCM. 1103.. |
| SM08656 | SM08663 | S20R SVUC R/L-11 | 51 € | |
| SM08717 | SM08724 | S25S SVUC R/L-16 | 53 € | VCM. 1604.. |
| SM39988 | SM52017 | S25S SVUC R/L-16S | 51 € | |
| SM08731 | SM08748 | S32T SVUC R/L-16 | 78 € | |
| SM08755 | SM08762 | S40U SVUC R/L-16 | 90 € | |



| Ordering Code | | Item Designation | Price | Master Insert* |
|------------------|-------------|------------------------|-------------|---|
| <i>Direction</i> | | SVQC R/L(107.5) | <i>EURO</i> |  |
| <i>Right</i> | <i>Left</i> | | | |
| SM08649 | SM08694 | S16P SVQC R/L-11 | 43 € | VCM. 1103.. |
| SM08670 | SM08700 | S20R SVQC R/L-11 | 51 € | |
| SM08779 | SM08786 | S25S SVQC R/L-16 | 53 € | VCM. 1604.. |
| SM49475 | SM49482 | S25S SVQC R/L-16S | 51 € | |
| SM08793 | SM08809 | S32T SVQC R/L-16 | 78 € | |
| SM08816 | SM08823 | S40U SVQC R/L-16 | 90 € | |

| Size Designation | Master Insert* | Spare Parts | | | |
|------------------|---|-----------------------------|--------------------------|------------------------------------|--------------|
| |  | Screw | Shim | Shim Screw | Torx Key |
| S16.. - S20 | VCM. 1103.. | SSV M2.5x6- 9505 | - | | STK-T08-9908 |
| S25.. | VCM. 1604.. | SSV M3.5x10- 9511 | BAX VC16- 9620 | SBV5 M5x0.5 A3.5x9- 9408 | STK-T15-9910 |
| S25(S).. | | SSV M3.5x14- 9512 | | SBV M5x0.5 A3.5x11- 9407 | |
| S32.. - S40.. | | | | | |

INTERNAL TURNING TOOLS



| Ordering Code | | Item Designation | Price | Master Insert* |
|------------------|-------------|-----------------------|--------------|----------------|
| <i>Direction</i> | | E-SCLC R/L(95) | EURO | |
| <i>Right</i> | <i>Left</i> | | | |
| SM60074 | SM60135 | E08K SCLC R/L-06 | 120 € | CCM. 0602.. |
| SM60081 | SM60142 | E10M SCLC R/L-06 | 175 € | |
| SM60098 | SM60159 | E12Q SCLC R/L-06 | 250 € | |
| SM60104 | SM60166 | E12Q SCLC R/L-09 | 250 € | CCM. 09T3 |
| SM60111 | SM60173 | E16R SCLC R/L-09 | 295 € | |
| SM60128 | SM60180 | E20S SCLC R/L-09 | 560 € | |



| Ordering Code | | Item Designation | Price | Master Insert* |
|------------------|-------------|---------------------------|--------------|----------------|
| <i>Direction</i> | | E-SCLC R/L(95) SET | EURO | |
| <i>Right</i> | <i>Left</i> | | | |
| SM60197 | SM60203 | E08K SCLCR/L-06 | 850 € | CCM. 0602.. |
| | | E10M SCLCR/L-06 | | |
| | | E12Q SCLCR/L-06 | | |
| | | E16R SCLCR/L-09 | | CCM. 09T3 |

| Size Designation | Master Insert* | Spare Parts | | | |
|------------------|----------------|--------------------|-------------|-------------------|-----------------|
| | | <i>Screw</i> | <i>Shim</i> | <i>Shim Screw</i> | <i>Torx Key</i> |
| E08.. | CCM. 0602.. | | | | |
| E10.. - E12 | | SSV M2.5x5-9504 | - | - | |
| E16.. | CCM. 09T3.. | SSV M2.5x6-9505 | - | - | STK-T15-9910 |
| | | SSV M3.5x8-9510 | - | - | |



| Ordering Code | | Item Designation | Price | Master Insert* |
|------------------|-------------|-----------------------|-------------|----------------|
| <i>Direction</i> | | A-SCLC R/L(95) | EURO | |
| <i>Right</i> | <i>Left</i> | | | |
| SM36376 | SM36383 | A08H SCLC R/L-06 | 36 € | CCM. 0602.. |
| SM36390 | SM36406 | A10H SCLC R/L-06 | 36 € | |
| SM36413 | SM36420 | A12H SCLC R/L-06 | 40 € | |
| SM36437 | SM36444 | A16M SCLC R/L-09 | 46 € | CCM. 09T3.. |
| SM36451 | SM36468 | A20P SCLC R/L-09 | 50 € | |
| SM36475 | SM36482 | A25R SCLC R/L-09 | 57 € | |
| SM36499 | SM36505 | A32S SCLC R/L-09 | 90 € | |



| Ordering Code | | Item Designation | Price | Master Insert* |
|------------------|-------------|---------------------------|-------------|----------------|
| <i>Direction</i> | | A-SCLC R/L(95) SET | EURO | |
| <i>Right</i> | <i>Left</i> | | | |
| SM60050 | SM60067 | A08H SCLC R/L-06 | 174 € | CCM. 0602.. |
| | | A10H SCLC R/L-06 | | |
| | | A12H SCLC R/L-06 | | |
| | | A16M SCLC R/L-09 | | CCM. 09T3.. |

*Suitable Insert is ISO

**Spare Parts Ordering Codes













S System
Internal
Lathe Tool Holders



| Ordering Code | | Item Designation | Price | Master Insert* |
|------------------|-------------|---------------------|-------------|---|
| <i>Direction</i> | | SCLC R/L(95) | <i>EURO</i> |  |
| <i>Right</i> | <i>Left</i> | | | |
| SM06393 | SM06461 | S06x08H SCLC R/L-06 | 29 € | CCM. 0602.. |
| SM06317 | SM06362 | S08H SCLC R/L-06 | 29 € | |
| SM06324 | SM06331 | S10K SCLC R/L-06 | 29 € | |
| SM06348 | SM06355 | S12K SCLC R/L-06 | 32 € | |
| SM06386 | SM26049 | S16x10M SCLC R/L-06 | 43 € | |
| SM06379 | SM26056 | S16x12M SCLC R/L-06 | 43 € | |
| SM00548 | SM00555 | S16P SCLC R/L-06 | 36 € | CCM. 09T3 |
| SM37793 | SM37809 | S12K SCLC R/L-09 | 34 € | |
| SM06478 | SM06485 | S16P SCLC R/L-09 | 36 € | |
| SM06492 | SM06508 | S20R SCLC R/L-09 | 40 € | |
| SM06515 | SM06522 | S25S SCLC R/L-09 | 47 € | |
| SM39438 | SM39445 | S25S SCLC R/L-09S | 50 € | |
| SM06539 | SM06546 | S32T SCLC R/L-09 | 72 € | CCM.1204.. |
| SM49451 | SM49468 | S25S SCLC R/L-12 | 53 € | |
| SM06638 | SM06645 | S32T SCLC R/L-12 | 78 € | |
| SM06676 | SM06683 | S40U SCLC R/L-12 | 92 € | |



| Ordering Code | | Item Designation | Price | Master Insert* |
|------------------|-------------|-----------------------------|-------------|---|
| <i>Direction</i> | | SCLC R/L(95) SET | <i>EURO</i> |  |
| <i>Right</i> | <i>Left</i> | | | |
| SM60210 | SM60227 | S08H SCLC R/L-06 | 143 € | CCM. 0602.. |
| | | S10K SCLC R/L-06 | | |
| | | S12K SCLC R/L-06 | | |
| | | S16P SCLC R/L-09 | | |

| Size Designation | Master Insert* | Spare Parts | | | | | | |
|------------------|--|---|---|---|---|--|---------------|--------------|
| | | Screw | Shim | Shim Screw | Torx Key | | | |
| A0608.. - A08 |  |  SSV M2.5x5-9504 |  |  |  | | | |
| A10.. - A16 | | | | | | - | - | STK-T08-9908 |
| A12.. - A16 | CCM. 09T3.. |  SSV M2.5x6-9505 |  |  |  | | | |
| A20.. - A20.. | | | | | | - | - | STK-T15-9910 |
| A25.. | | | | | |  SSV M3.5x10-9511 | BAX CC09-9616 | |
| A32.. |  SSV M3.5x14-9512 |  SBV M5x0.5 A3.5x11-9407 | | | | | | |





| Ordering Code | | Item Designation | Price | Master Insert* |
|---------------|---------|---------------------|-------|---|
| Direction | | SCFC R/L(90) | EURO |  |
| Right | Left | | | |
| SM06409 | SM06416 | S08H SCFC R/L-06 | 29 € | CCM. 0602.. |
| SM06423 | SM06430 | S10K SCFC R/L-06 | 29 € | |
| SM06447 | SM06454 | S12K SCFC R/L-06 | 32 € | |
| SM37816 | SM37823 | S12K SCFC R/L-09 | 34 € | CCM. 09T3.. |
| SM06553 | SM06560 | S16P SCFC R/L-09 | 36 € | |
| SM06577 | SM06584 | S20R SCFC R/L-09 | 40 € | |
| SM06591 | SM06607 | S25S SCFC R/L-09 | 47 € | |
| SM06614 | SM06621 | S25S SCFC R/L-12 | 51 € | CCM.1204.. |
| SM06652 | SM06669 | S32T SCFC R/L-12 | 78 € | |
| SM06690 | SM06706 | S40U SCFC R/L-12 | 92 € | |

S System Internal Lathe Tool Holders

| Size Designation | Master Insert* | Spare Parts | | | |
|------------------|---|---|------------------|--|--------------|
| |  | Screw | Shim | Shim Screw | Torx Key |
| S0608.. - S08 | CCM. 0602.. |  SSV M2.5x5-9504 | - | - | STK-T08-9908 |
| S10.. - S16 | | SSV M2.5x6-9505 | - | - | |
| S12.. - S16.. | CCM. 09T3.. | SSV M3.5x8-9510 | - | - | STK-T15-9910 |
| S20.. - S25.. | | SSV M3.5x10-9511 | BAX CC09-9616 | SBV5 M5x0.5 A3.5x9-9408 SBV M5x0.5 A3.5x11-9407 | |
| S25(S).. | | SSV M3.5x14-9512 | | | |
| S32.. | | SSV M4x12x6-9517 | - | - | |
| S25.. | CCM. 1204.. | - | BAX CC12-9617 | SBV4 M6x0.75 A4x9 9411 | |
| S32.. - S40.. | | - | - | - | |



| Ordering Code | | Item Designation | Price | Master Insert* |
|---------------|---------|---------------------|-------|---|
| Direction | | SSSC R/L(45) | EURO |  |
| Right | Left | | | |
| SM07512 | SM07543 | S16P SSSC R/L-09 | 36 € | SCM. 09T3.. |
| SM07529 | SM07550 | S20R SSSC R/L-09 | 40 € | |
| SM07536 | SM07574 | S25S SSSC R/L-09 | 47 € | |
| SM49512 | SM49529 | S25S SSSC R/L-12 | 51 € | SCM. 1204.. |
| SM07604 | SM07581 | S32T SSSC R/L-12 | 78 € | |
| SM07611 | SM07598 | S40U SSSC R/L-12 | 92 € | |

| Size Designation | Master Insert* | Spare Parts | | | |
|------------------|---|--|------|----------------------------|--------------|
| |  | Screw | Shim | Shim Screw | Torx Key |
| S16.. - S25 | SCM. 09T3.. |  SSV M3.5x10-9511 | - | - | STK-T15-9910 |
| S25.. | SCM. 1204.. | SSV M4x12x6-9517 | - | SBV4 M6x0.75 A4x9- 9411 | |
| S32.. - S40.. | | BAX SC12-9615 | - | | |

*Suitable Insert is ISO

**Spare Parts Ordering Codes



| Ordering Code | | Item Designation | Price | Master Insert* |
|------------------|-------------|-----------------------|--------------|----------------|
| <i>Direction</i> | | E-STUC R/L(93) | EURO | |
| <i>Right</i> | <i>Left</i> | | | |
| SM60234 | SM60272 | E10M STUC R/L-09 | 175 € | TCM.0902.. |
| SM60241 | SM60289 | E12Q STUC R/L-09 | 250 € | |
| SM60258 | SM60296 | E12Q STUC R/L-11 | 250 € | TCM.1102.. |
| SM60265 | SM60302 | E16R STUC R/L-11 | 295 € | |



| Ordering Code | | Item Designation | Price | Master Insert* |
|------------------|-------------|-------------------------------|--------------|----------------|
| <i>Direction</i> | | E-STUC R/L(93) SET | EURO | |
| <i>Right</i> | <i>Left</i> | | | |
| SM60319 | SM60326 | E10M STUC R/L-09 | 768 € | TCM.0902.. |
| | | E12Q STUC R/L-09 | | |
| | | E16R STUC R/L-11 | | TCM.1102.. |

| Size Designation | Master Insert* | Spare Parts | | | |
|------------------|----------------|------------------------|------|------------|--------------|
| | | Screw | Shim | Shim Screw | Torx Key |
| E10.. - E12.. | TCM.0902.. | SSV M2.2x5-9503 | | | STK-T06-9906 |
| E16.. | TCM.1102.. | SSV M2.5x5-9504 | - | - | STK-T08-9908 |



| Ordering Code | | Item Designation | Price | Master Insert* |
|------------------|-------------|---------------------|-------------|----------------|
| <i>Direction</i> | | STUC R/L(93) | EURO | |
| <i>Right</i> | <i>Left</i> | | | |
| SM07642 | SM07659 | S10K STUC R/L-09 | 29 € | TCM.0902.. |
| SM07680 | SM07697 | S12K STUC R/L-09 | 32 € | |
| SM07802 | SM07789 | S10K STUC R/L-11 | 29 € | TCM.1102.. |
| SM07741 | SM07772 | S12K STUC R/L-11 | 32 € | |
| SM07840 | SM07857 | S16P STUC R/L-11 | 36 € | |
| SM07901 | SM07918 | S20R STUC R/L-11 | 40 € | TCM.16T3.. |
| SM07963 | SM08076 | S16P STUC R/L-16 | 36 € | |
| SM07970 | SM08113 | S20R STUC R/L-16 | 40 € | |
| SM07987 | SM08083 | S25S STUC R/L-16 | 47 € | |
| SM39483 | SM39476 | S25S STUC R/L-16S | 51 € | |
| SM08168 | SM08175 | S32T STUC R/L-16 | 78 € | |
| SM08205 | SM08212 | S40U STUC R/L-16 | 90 € | |



| Ordering Code | | Item Designation | Price | Master Insert* |
|---------------|---------|---------------------|-------|---|
| Direction | | <i>STFC R/L(90)</i> | EURO |  |
| Right | Left | | | |
| SM07628 | SM07635 | S10x06K STFC R/L-06 | 29 € | TCM.0602.. |
| SM07666 | SM07673 | S10K STFC R/L-09 | 29 € | TCM.0902.. |
| SM07703 | SM07710 | S12K STFC R/L-09 | 32 € | |
| SM07819 | SM07796 | S10K STFC R/L-11 | 29 € | TCM.1102.. |
| SM07826 | SM07833 | S12K STFC R/L-11 | 32 € | |
| SM07864 | SM07871 | S16P STFC R/L-11 | 36 € | |
| SM07925 | SM07932 | S20R STFC R/L-11 | 40 € | |
| SM08090 | SM08106 | S16P STFC R/L-16 | 36 € | TCM.16T3.. |
| SM08120 | SM08137 | S20R STFC R/L-16 | 40 € | |
| SM08144 | SM08151 | S25S STFC R/L-16 | 47 € | |
| SM39452 | SM39469 | S25S STFC R/L-16S | 51 € | |
| SM08182 | SM08199 | S32T STFC R/L-16 | 78 € | |
| SM08229 | SM08236 | S40U STFC R/L-16 | 90 € | |



| Ordering Code | | Item Designation | Price | Master Insert* |
|---------------|---------|---------------------|-------|--|
| Direction | | <i>ST-C R/L(60)</i> | EURO |  |
| Right | Left | | | |
| SM07727 | SM07734 | S12K ST-C R/L-09 | 32 € | TCM.0902.. |
| SM07758 | SM07765 | S12K ST-C R/L-11 | 32 € | TCM.1102.. |
| SM07888 | SM07895 | S16P ST-C R/L-11 | 36 € | |
| SM07949 | SM07956 | S20R ST-C R/L-11 | 40 € | |
| SM07994 | SM08007 | S16P ST-C R/L-16 | 36 € | TCM.16T3. |
| SM08014 | SM08021 | S20R ST-C R/L-16 | 40 € | |
| SM08038 | SM08045 | S25S ST-C R/L-16 | 47 € | |
| SM08052 | SM08069 | S32T ST-C R/L-16 | 78 € | |
| SM08243 | SM08250 | S40U ST-C R/L-16 | 90 € | |



| Ordering Code | | Item Designation | Price | Master Insert* |
|---------------|---------|---------------------|-------|---|
| Direction | | <i>SWLC R/L(95)</i> | EURO |  |
| Right | Left | | | |
| SM08854 | SM08830 | S0608H SWLC R/L-03 | 29 € | WCM.0302.. |
| SM08861 | SM08847 | S0810K SWLC R/L-03 | 32 € | |

| Size Designation | Master Insert* | Spare Parts | | | |
|-------------------|---|---|------|------------|---|
| |  | Screw | Shim | Shim Screw | Torx Key |
| S0608.. - S0810.. | WCM.0302.. |  SSV M2.5x5-9504 | - | - |  STK-T08-9908 |

S System Internal Lathe Tool Holders

*Suitable Insert is ISO
**Spare Parts Ordering Codes

| Insert | | MGM. 2C KRLY | MGM. 2.5C KRLY | MGM. 3C KRLY | MGM. 4C KRLY | MGM. 5C KRLY | MGM. 6C KRLY | |
|------------------|---|---|---|---|---|---|---|---|
| | |  |  |  |  |  |  | |
| Size (mm) | | #1212 - 3232 | #2020 - 2525 | #1212 - 3232 | #2020 - 3232 | #2020 - 3232 | #2525 - 3232 | |
| Item Code | | BDKT R/L | BDKT R/L | BDKT R/L | BDKT R/L | BDKT R/L | BDKT R/L | |
| T Max. (mm) | | 15-18mm | 18mm | 18-40mm | 20-40mm | 20-40mm | 25mm | |
| Application Type | External Grooving |  | ✓ | ✓ | ✓ | ✓ | ✓ | |
| | Page | | C85 | C85 | C85 | C85 | C85 | |
| | Long Ext. Grooving |  | - | - | ✓ T Max:40mm | ✓ T Max:40mm | ✓ T Max:40mm | - |
| | Page | | | C85 | C85 | C85 | | |
| | External Turning |  | - | - | - | - | - | |
| | Page | | | | | | | |
| | Swiss Type |  | ✓ | - | ✓ | | | |
| | Page | | C95 | | C95 | | | |
| | Parting (Blade) |  | - | - | - | - | - | |
| | Page | | | | | | | |
| | Edge Grooving |  | - | - | - | - | - | |
| | Page | | | | | | | |
| Face Grooving |  | - | - | ✓ | ✓ | ✓ | | |
| Page | | | | C96-97 | C96-97 | C96-97 | | |

| Insert | | MRM. 3C KRLY | MRM. 4C KRLY | MRM. 5C KRLY | MRM. 6C KRLY | KGM.2C KRLY | KGM.3C KRLY | |
|------------------|---|---|---|---|---|---|---|------------|
| | |  |  |  |  |  |  | |
| Size (mm) | | #2020 - 3232 | #2020 - 3232 | #2525 - 3232 | #3232 | #1212 - 2525 | #2020 - 2525 | |
| Item Code | | BDRT R/L | BDRT R/L | BDRT R/L | BDRT R/L | BDKT R/L | BDKT R/L | |
| T Max. (mm) | | 2.8mm | 2.8mm | 2.8mm | 2.8mm | 15-18mm | 20-22mm | |
| Application Type | External Grooving |  | - | - | - | - | ✓ | ✓ |
| | Page | | | | | | C86 | C86 |
| | Long Ext. Grooving |  | - | - | - | - | - | - |
| | Page | | | | | | | |
| | External Turning |  | - | - | - | - | ✓ | ✓ |
| | Page | | | | | | C86 | C86 |
| | Swiss Type |  | - | - | - | - | ✓ | - |
| | Page | | | | | | C95 | |
| | Parting (Blade) |  | - | - | - | - | - | - |
| | Page | | | | | | | |
| | Edge Grooving |  | ✓ | ✓ | ✓ | ✓ | - | - |
| | Page | | C86 | C86 | C86 | C86 | | |
| Face Grooving |  | - | - | - | - | - | - | |
| Page | | | | | | | | |





| Insert | | KGM. 4C KRLY | KGM. 5C KRLY | KGM. 6C KRLY | DGN. 2C | DGN. 2.2C | DGN. 3C |
|------------------|---|---|---|---|--|---|---|
| | |  |  |  |  |  |  |
| Size (mm) | | #2020 - 2525 | #2525 | #2525 | #1212 - 2525 | #2020 - 2525 | #1212 - 3232 |
| Item Code | | BDKT R/L | BDKT R/L | BDKT R/L | BDKT R/L | BDKT R/L | BDKT R/L |
| T Max. (mm) | | 20-22mm | 25mm | 20-22mm | 15-18mm | 18mm | 15-25mm |
| Application Type | External Grooving |  | ✓ | ✓ | ✓ | ✓ | ✓ |
| | Page | | C86 | C86 | C86 | C87 | C87 |
| | Long Ext. Grooving |  | - | - | - | - | ✓ T Max:40mm |
| | Page | | | | | | C87 |
| | External Turning |  | ✓ | ✓ | ✓ | - | - |
| | Page | | C86 | C86 | C86 | | |
| | Swiss Type |  | - | - | - | ✓ | - |
| | Page | | | | | C94 | C94 |
| | Parting (Blade) |  | - | - | - | ✓ | - |
| | Page | | | | | C83 | C83 |
| | Edge Grooving |  | - | - | - | - | - |
| | Page | | | | | | |
| Face Grooving |  | - | - | - | - | - | |
| Page | | | | | | | |

| Insert | | GRIP 3C | GRIP 4C | GRIP 5C | GIM. 3C | TGM 3C | TGM 4C | TDC. 2C TGTC | |
|------------------|---|---|---|---|--|---|---|---|------------|
| | |  |  |  |  |  |  |  | |
| Size (mm) | | #1212 - 3232 | #2020 - 3232 | #3232 | #1616 - 2525 | #2020 - 2525 | #2020 - 2525 | #1010 - 2525 | |
| Item Code | | BDKT R/L | BDKT R/L | BDKT R/L | BDKT R/L | BDKT R/L | BDKT R/L | BDKT R/L | |
| T Max. (mm) | | 15-22mm | 20-40mm | 25mm | 15-22mm | 20-22mm | 20-22mm | 15-18mm | |
| Application Type | External Grooving |  | ✓ | ✓ | ✓ | ✓ | ✓ | ✓ | |
| | Page | | C87 | C87 | C87 | C87 | C87 | C88 | |
| | Long Ext. Grooving |  | - | ✓ T Max:40mm | - | - | - | - | |
| | Page | | | | | | | | |
| | External Turning |  | ✓ | ✓ | ✓ | - | ✓ | ✓ | |
| | Page | | C87 | C87 | C87 | | 87 | C87 | C94 |
| | Swiss Type |  | - | - | - | - | - | - | |
| | Page | | | | | | | | |
| | Parting (Blade) |  | - | ✓ | - | - | - | - | ✓ |
| | Page | | | C83 | | | | | C83 |
| | Edge Grooving |  | - | - | - | - | - | - | |
| | Page | | | | | | | | |
| Face Grooving |  | - | ✓ | - | - | - | - | | |
| Page | | | C97 | | | | | | |

| Insert | | TDC. 3C TGTC | TDC. 4C TGTC | GDM. 2C KYC | GDM. 3C KYC | GDM. 4C KYC | ZTDB 2C ZCC | ZTFD 3C ZCC |
|------------------|---|---|---|---|--|---|---|---|
| | |  |  |  |  |  |  |  |
| Size (mm) | | #1212 - 2525 | #2020 - 2525 | #2020 - 2525 | #2020 - 2525 | #2020 - 2525 | #1616 - 2525 | #1616 - 2525 |
| Item Code | | BDKT R/L | BDKT R/L | BDKT R/L | BDKT R/L | BDKT R/L | BDKT R/L | BDKT R/L |
| T Max. (mm) | | 15-18mm | 20-22mm | 18mm | 20-22mm | 20-22mm | 18mm | 18-20mm |
| Application Type | External Grooving |  | ✓ | ✓ | ✓ | ✓ | ✓ | ✓ |
| | Page | | C88 | C88 | C88 | C88 | C89 | C89 |
| | Long Ext. Grooving |  | - | - | - | - | - | - |
| | Page | | | | | | | |
| | External Turning |  | - | - | - | - | - | - |
| | Page | | | | | | | |
| | Swiss Type |  | ✓ | - | - | - | - | - |
| | Page | | | | | | | |
| | Parting (Blade) |  | - | ✓ | - | - | - | ✓ |
| | Page | | | C83 | | | | C84 |
| | Edge Grooving |  | - | - | - | - | - | - |
| | Page | | | | | | | |
| Face Grooving |  | - | - | - | - | - | ✓ | |
| Page | | | | | | | C98 | |

| Insert | | ZTGD 4C ZCC | ZTHD 5C ZCC | GCTX 2C LMN | GCTX 3C LMN | 123 2C SNDV | 123 3C SNDV | |
|------------------|---|---|---|---|---|---|---|------------|
| | |  |  |  |  |  |  | |
| Size (mm) | | #2020 - 2525 | #2020 - 2525 | #1616 - 2525 | #1616 - 2525 | #1212 - 2525 | #1212 - 2525 | |
| Item Code | | BDKT R/L | BDKT R/L | BDKT R/L | BDKT R/L | BDKT R/L | BDKT R/L | |
| T Max. (mm) | | 20-22mm | 20-25mm | 18mm | 18-22mm | 15-18mm | 15-18mm | |
| Application Type | External Grooving |  | ✓ | ✓ | ✓ | ✓ | ✓ | |
| | Page | | C89 | C89 | C89 | C89 | C90 | |
| | Long Ext. Grooving |  | - | - | - | - | - | |
| | Page | | | | | | | |
| | External Turning |  | - | - | - | - | - | |
| | Page | | | | | | | |
| | Swiss Type |  | - | - | - | - | - | |
| | Page | | | | | | | |
| | Parting (Blade) |  | ✓ | - | - | - | ✓ | ✓ |
| | Page | | C84 | | | | C84 | C84 |
| | Edge Grooving |  | - | - | - | - | - | - |
| | Page | | | | | | | |
| Face Grooving |  | ✓ | - | - | - | - | - | |
| Page | | C98 | | | | | | |

| Insert | | 123 4C SNDV | 123 5C SNDV | 151.2 2C SNDV | 151.2 3C SNDV | 151.2 4C SNDV | 151.2 5C SNDV |
|------------------|---|---|---|---|---|---|---|
| | |  |  |  |  |  |  |
| Size (mm) | | #2020 - 2525 | #2020 - 2525 | #1616 - 2525 | #1616 - 2525 | #1616 - 2525 | #2020 - 2525 |
| Item Code | | BDKT R/L | BDKT R/L | BDKT R/L | BDKT R/L | BDKT R/L | BDKT R/L |
| T Max. (mm) | | 20-22mm | 22-25mm | 18mm | 18-22mm | 18-22mm | 20-25mm |
| Application Type | External Grooving |  | ✓ | ✓ | ✓ | ✓ | ✓ |
| | Page | | C90 | C91 | C91 | C91 | C91 |
| | Long Ext. Grooving |  | - | - | - | - | - |
| | Page | | | | | | |
| | External Turning |  | - | - | ✓ | ✓ | ✓ |
| | Page | | | | C91 | C91 | C91 |
| | Swiss Type |  | - | - | - | - | - |
| | Page | | | | | | |
| | Parting (Blade) |  | ✓ | - | - | ✓ | ✓ |
| | Page | | C84 | | | C83 | C83 |
| | Edge Grooving |  | - | - | - | - | - |
| | Page | | | | | | |
| Face Grooving |  | - | - | - | - | - | |
| Page | | | | | | | |

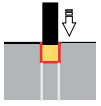
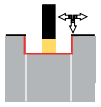
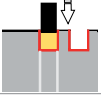
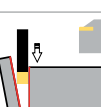
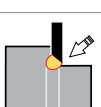
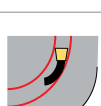
| Insert | | GX16 2C WLTR | GX16 3C WLTR | GX24 2C WLTR | GX24 3C WLTR | GX24 4C WLTR |
|------------------|---|---|---|--|---|---|
| | |  |  |  |  |  |
| Size (mm) | | #2020 - 2525 | #2020 - 2525 | #2020 - 2525 | #2020 - 2525 | #2525 |
| Item Code | | BDKT R/L | BDKT R/L | BDKT R/L | BDKT R/L | BDKT R/L |
| T Max. (mm) | | 18mm | 20-22mm | 18mm | 20-22mm | 22mm |
| Application Type | External Grooving |  | ✓ | ✓ | ✓ | ✓ |
| | Page | | C91 | C91 | C91 | C91 |
| | Long Ext. Grooving |  | - | - | - | - |
| | Page | | | | | |
| | External Turning |  | - | - | - | - |
| | Page | | | | | |
| | Swiss Type |  | - | - | - | - |
| | Page | | | | | |
| | Parting (Blade) |  | - | - | - | - |
| | Page | | | | | |
| | Edge Grooving |  | - | - | - | - |
| | Page | | | | | |
| Face Grooving |  | - | - | - | - | |
| Page | | | | | | |

| Insert | | GCM 2C SMTM | GCM 3C SMTM | S229 2C HORN | S229 3C HORN | S229 4C HORN | S229 5C HORN |
|------------------|---|---|--------------|--------------|--------------|--------------|--------------|
| Size (mm) | | #1212 - 2525 | #1616 - 2525 | #2020 - 2525 | #2020 - 2525 | #2020 - 2525 | #2020 - 2525 |
| Item Code | | BDKT R/L | BDKT R/L | BDKT R/L | BDKT R/L | BDKT R/L | BDKT R/L |
| T Max. (mm) | | 15-18mm | 15-22mm | 18mm | 20-22mm | 20-22mm | 20-25mm |
| Application Type | External Grooving |  | ✓ | ✓ | ✓ | ✓ | ✓ |
| | Page | | C93 | C93 | C92 | C92 | C92 |
| | Long Ext. Grooving |  | - | - | - | - | - |
| | Page | | | | | | |
| | External Turning |  | - | - | - | - | - |
| | Page | | | | | | |
| | Swiss Type |  | - | - | - | - | - |
| | Page | | | | | | |
| | Parting (Blade) |  | - | - | - | - | - |
| | Page | | | | | | |
| | Edge Grooving |  | - | - | - | - | - |
| | Page | | | | | | |
| Face Grooving |  | - | - | - | - | - | |
| Page | | | | | | | |

| Insert | | S224 2C HORN | S229 3C HORN | S229 4C HORN | S229 5C HORN | DGM / DTX 2C TNGLY | DGM / DTX 3C TNGLY |
|------------------|---|---|---|---|--|---|---|
| | |  |  |  |  |  |  |
| Size (mm) | | #2020 - 2525 | #2020 - 2525 | #2020 - 2525 | #2020 - 2525 | #2020 - 2525 | #2020 - 2525 |
| Item Code | | BDKT R/L | BDKT R/L | BDKT R/L | BDKT R/L | BDKT R/L | BDKT R/L |
| T Max. (mm) | | 18mm | 20-22mm | 20-22mm | 20-22mm | 18mm | 20-22mm |
| Application Type | External Grooving |  | ✓ | ✓ | ✓ | ✓ | ✓ |
| | Page | | C92 | C92 | C92 | C92 | C93 |
| | Long Ext. Grooving |  | - | - | - | - | - |
| | Page | | | | | | |
| | External Turning |  | - | - | - | - | ✓ |
| | Page | | | | | C93 | C93 |
| | Swiss Type |  | - | - | - | - | - |
| | Page | | | | | | |
| | Parting (Blade) |  | - | - | - | - | - |
| | Page | | | | | | |
| | Edge Grooving |  | - | - | - | - | - |
| | Page | | | | | | |
| Face Grooving |  | - | - | - | - | - | |
| Page | | | | | | | |

| Insert | | DGM / DTX 4C TNGLY | A4 - 2C KNMTL | A4 - 3C KNMTL | A4 - 4C KNMTL | | |
|------------------|--|---|---|---|---|---|---|
| | |  |  |  |  | | |
| Size (mm) | | #2020 - 2525 | #2020 - 2525 | #2020 - 2525 | #2020 - 2525 | | |
| Item Code | | BDKT R/L | BDKT R/L | BDKT R/L | BDKT R/L | | |
| T Max. (mm) | | 20-22mm | 18mm | 20-22mm | 20-22mm | | |
| Application Type | External Grooving |  ✓ DTM | ✓ | ✓ | ✓ | | |
| | Page | C93 | C94 | C94 | C94 | | |
| | Long Ext. Grooving |  - | - | - | - | | |
| | Page | | | | | | |
| | External Turning |  ✓ DTX | - | - | - | | |
| | Page | C93 | | | | | |
| | Swiss Type |  - | - | - | - | - | - |
| | Page | | | | | | |
| | Parting (Blade) |  - | - | - | - | - | - |
| | Page | | | | | | |
| | Edge Grooving |  - | - | - | - | - | - |
| | Page | | | | | | |
| Face Grooving |  - | - | - | - | - | - | |
| Page | | | | | | | |



| Ordering Code | Item Designation | Price | Master Insert* |
|---------------|------------------|----------------------|----------------|
| | | SML-Blade DGN | EURO |
| SM54714 | SML 26-ID2C | 95 € | DGN. 2C |
| SM54721 | SML 32-ID2C | 100 € | DGN. 2C |
| SM54738 | SML 26-ID3C | 95 € | DGN. 3C |
| SM54745 | SML 32-ID3C | 100 € | DGN. 3C |
| SM54752 | SML 26-IG4C | 95 € | GRIP 4C |
| SM54769 | SML 32-IG4C | 100 € | GRIP 4C |

| Size Designation | Master Insert* | Spare Parts |
|------------------|--------------------|-------------|
| | | |
| 26 - 32 | DGN / GRIP (2C-4C) | SBK-01-9901 |

*Suitable Insert brand is ISC.



| Ordering Code | Item Designation | Dimensions (mm) | Master Insert* |
|---------------|------------------|-----------------------------|----------------|
| | | SML-Blade TGTC - TDC | EURO |
| SM54820 | SML 32-TDC-2C | 100 € | TDC. 2C |
| SM54837 | SML 32-TDC-3C | 100 € | TDC. 3C |
| SM54844 | SML 32-TDC-4C | 100 € | TDC. 4C |

| Size Designation | Master Insert* | Spare Parts |
|------------------|----------------|-------------|
| | | |
| 32 | TDC (2C- 4C) | SBK-01-9901 |

*Suitable Insert brand is TGTC.



| Ordering Code | Item Designation | Price | Master Insert* |
|---------------|--------------------|------------------------------|----------------|
| | | SML-Blade SDV - 151.2 | EURO |
| SM54806 | SML 32-SDV151.2-3C | 100 € | 151.2-3C |
| SM54813 | SML 32-SDV151.2-4C | 100 € | 151.2-4C |

| Size Designation | Master Insert* | Spare Parts |
|------------------|----------------|-------------|
| | | |
| 32 | 151.2 (3C- 4C) | SBK-01-9901 |

*Suitable Insert brand is SDV.

External Parting and Grooving Tools



| Ordering Code | Item Designation | Price | Master Insert* |
|---------------|------------------|----------------------------|----------------|
| | | <i>SML-Blade SDV - 123</i> | EURO |
| SM54776 | SML 32-SDV123-2C | 100 € | 123-2C |
| SM54783 | SML 32-SDV123-3C | 100 € | 123-3C |
| SM54790 | SML 32-SDV123-4C | 100 € | 123-4C |

| Size Designation | Master Insert* | Spare Parts |
|------------------|----------------|-------------|
| | | |
| 32 | 123 (2C- 4C) | SBK-01-9901 |

*Suitable Insert brand is SDV.



| Ordering Code | Item Designation | Price | Master Insert* |
|---------------|------------------|--------------------------------|----------------|
| | | <i>SML-Blade ZCC-CT - ZT..</i> | EURO |
| SM54851 | SML 32-ZT-3C | 100 € | ZTFD 3C |
| SM54868 | SML 32-ZT-4C | 100 € | ZTGD 4C |

| Size Designation | Master Insert* | Spare Parts |
|------------------|----------------|-------------|
| | | |
| 32 | ZT.. (3C - 4C) | SBK-01-9901 |

*Suitable Insert brand is ZCC-CT





| Ordering Code | Item Designation | Price |
|---------------|------------------|--------------------------|
| | | <i>SMLK-Blade Holder</i> |
| SM54875 | SMLK 20-26 | 92 € |
| SM54882 | SMLK 20-32 | 92 € |
| SM54899 | SMLK 25-26 | 102 € |
| SM54905 | SMLK 25-32 | 102 € |
| SM54912 | SMLK 32-32 | 102 € |

| Ordering Code | Blade Clamp | Descriptions | Clamp Screw | Allen Key |
|---------------|-------------|--------------|-----------------|-----------|
| | | | | |
| SM54929 | SMK1-075 | SMLK 20-26 | BKTV-M6x30-9240 | AA5 |
| SM54936 | SMK2-090 | SMLK 20-26 | BKTV-M6x35-9241 | |
| SM54943 | SMK3-100 | SMLK 20-26 | | |



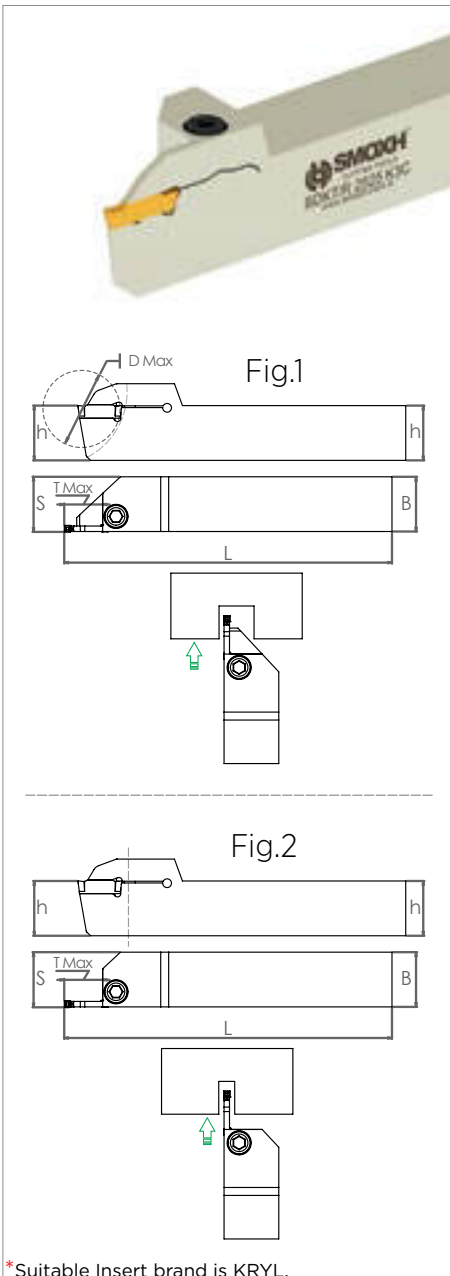

| Ordering Code | | Item Designation | Price | Master Insert* |
|---------------|---------|-------------------------------|-------|---|
| Direction | | BDKT R/L-MGM | EURO |  |
| Right | Left | | | |
| SM56183 | SM56190 | 2525 BDKT R/L-K3C t max:22-JC | 135 € | MGM. 3C |
| SM56206 | SM56213 | 2525 BDKT R/L-K4C t max:22-JC | 135 € | MGM. 4C |







| Ordering Code | | Item Designation | Master Insert* | | |
|---------------|---------|------------------------------|----------------|-------|---|
| Direction | | BDKT R/L-MGM | Fig. | EURO |  |
| Right | Left | | | | |
| SM09493 | SM09691 | 1212 BDKT R/L-K2C t max:15 | 1 | 62 € | MGM. 2C |
| SM09479 | SM09660 | 1616 BDKT R/L-K2C t max:18 | 1 | 67 € | |
| SM09455 | SM09653 | 2020 BDKT R/L-K2C t max:18 | 1 | 69 € | |
| SM27411 | SM38851 | 2020 BDKT R/L-K2C t max:12 | 1 | 69 € | |
| SM09462 | SM09677 | 2525 BDKT R/L-K2C t max:18 | 1 | 73 € | MGM. 2.5C |
| SM09486 | SM09684 | 3232 BDKT R/L-K2C t max:18 | 1 | 83 € | |
| SM47747 | SM47754 | 2020 BDKT R/L-K2.5C t max:18 | 1 | 69 € | MGM. 3C |
| SM47761 | SM47778 | 2525 BDKT R/L-K2.5C t max:18 | 1 | 73 € | |
| SM09547 | SM09745 | 1212 BDKT R/L-K3C t max:18 | 1 | 62 € | MGM. 3C |
| SM09523 | SM09714 | 1616 BDKT R/L-K3C t max:18 | 1 | 67 € | |
| SM09509 | SM09707 | 2020 BDKT R/L-K3C t max:20 | 1 | 69 € | |
| SM57258 | SM57265 | 2020 BDKT R/L-K3C-T t max:20 | 2 | 69 € | |
| SM09516 | SM09721 | 2525 BDKT R/L-K3C t max:22 | 1 | 73 € | |
| SM57173 | SM57180 | 2525 BDKT R/L-K3C-T t max:22 | 2 | 73 € | |
| SM24601 | SM25141 | 2525 BDKT R/L-K3C t max:25 | 1 | 83 € | |
| SM57197 | SM57203 | 2525 BDKT R/L-K3C-T t max:25 | 2 | 83 € | |
| SM24625 | SM25134 | 2525 BDKT R/L-K3C t max:40 | 1 | 123 € | |
| SM09530 | SM09738 | 3232 BDKT R/L-K3C t max:22 | 1 | 83 € | |
| SM09554 | SM09752 | 2020 BDKT R/L-K4C t max:20 | 1 | 69 € | MGM. 4C |
| SM57272 | SM57289 | 2020 BDKT R/L-K4C-T t max:20 | 2 | 69 € | |
| SM27428 | SM38844 | 2020 BDKT R/L-K4C t max:25 | 1 | 69 € | |
| SM09561 | SM09769 | 2525 BDKT R/L-K4C t max:22 | 1 | 73 € | |
| SM24618 | SM25127 | 2525 BDKT R/L-K4C t max:25 | 1 | 83 € | MGM. 5C |
| SM24687 | SM25110 | 2525 BDKT R/L-K4C t max:40 | 1 | 123 € | |
| SM09578 | SM09776 | 3232 BDKT R/L-K4C t max:22 | 1 | 83 € | |
| SM09585 | SM09783 | 2020 BDKT R/L-K5C t max:20 | 1 | 69 € | MGM. 6C |
| SM09592 | SM09790 | 2525 BDKT R/L-K5C t max:25 | 1 | 73 € | |
| SM37830 | SM37847 | 2525 BDKT R/L-K5C t max:40 | 1 | 123 € | MGM. 8C |
| SM09608 | SM09806 | 3232 BDKT R/L-K5C t max:25 | 1 | 83 € | |
| SM09615 | SM09813 | 2525 BDKT R/L-K6C t max:25 | 1 | 73 € | |
| SM09622 | SM09820 | 3232 BDKT R/L-K6C t max:25 | 1 | 83 € | |
| SM09646 | SM09837 | 2525 BDKT R/L-K8C t max:25 | 1 | 73 € | MGM. 8C |
| SM09639 | SM09844 | 3232 BDKT R/L-K8C t max:27 | 1 | 83 € | |



*Suitable Insert brand is KRYL.



| Size Designation | Master Insert* | Spare Parts | |
|------------------|---|--|--|
| |  | Screw  | Allen Key  |
| 1212 | MGM (2C - 3C) | BKTV M5x17-9211 | SAK-AA4-9903 |
| 1616 | | BKTV M6x25-9215 | |
| 2020 - 3232 | MGM (2C) | BKTV M6x25-9215 | |
| 2020 - 3232 | MGM (3C - 8C) | BKTV M8x1x25-9232 | |

External Parting and Grooving Tools

|  | Ordering Code | | Item Designation | Price | Master Insert* |
|---|---------------|------------------------------|---------------------------|---------|---|
| | Direction | | BDRT R/L-MRMN (45) | EURO |  |
| | Right | Left | | | |
| SM47785 | SM47792 | 2020 BDRT R/L-KR3C t max:2.8 | 73 € | MR.. 3C | |
| SM47808 | SM47815 | 2525 BDRT R/L-KR3C t max:2.8 | 73 € | | |
| SM47822 | SM47839 | 3232 BDRT R/L-KR3C t max:2.8 | 86 € | | |
| SM47846 | SM47853 | 2020 BDRT R/L-KR4C t max:2.8 | 73 € | MR.. 4C | |
| SM47860 | SM47877 | 2525 BDRT R/L-KR4C t max:2.8 | 73 € | | |
| SM47884 | SM47891 | 3232 BDRT R/L-KR4C t max:2.8 | 86 € | | |
| SM47907 | SM47914 | 2525 BDRT R/L-KR5C t max:2.8 | 73 € | MR.. 5C | |
| SM47921 | SM47938 | 3232 BDRT R/L-KR5C t max:2.8 | 86 € | | |
| SM47952 | SM47945 | 3232 BDRT R/L-KR6C t max:2.8 | 86 € | MR.. 6C | |

| Size Designation | Master Insert* | Spare Parts | |
|------------------|---|--|---|
| |  | Screw | Allen Key |
| 2020 - 3232 | MRMN (3C - 6C) |  BKTV M8x1x25-9232 |  SAK-AA4-9903 |

|  | Ordering Code | | Item Designation | Price | Master Insert* |
|---|---------------|-----------------------------|---------------------|----------|---|
| | Direction | | BDKT R/L-KGM | EURO |  |
| | Right | Left | | | |
| SM24656 | SM24649 | 1212 BDKT R/L-KG2C t max:15 | 67 € | KGM.. 2C | |
| SM25011 | SM25059 | 1616 BDKT R/L-KG2C t max:18 | 67 € | | |
| SM25004 | SM25042 | 2020 BDKT R/L-KG2C t max:18 | 69 € | | |
| SM24403 | SM25097 | 2525 BDKT R/L-KG2C t max:18 | 73 € | KGM.. 3C | |
| SM24991 | SM25035 | 2020 BDKT R/L-KG3C t max:20 | 69 € | | |
| SM24410 | SM25080 | 2525 BDKT R/L-KG3C t max:22 | 73 € | | |
| SM24984 | SM25028 | 2020 BDKT R/L-KG4C t max:20 | 69 € | KGM.. 4C | |
| SM24427 | SM25073 | 2525 BDKT R/L-KG4C t max:22 | 73 € | | |
| SM24434 | SM25066 | 2525 BDKT R/L-KG5C t max:25 | 73 € | KGM.. 5C | |
| SM24632 | SM25103 | 2525 BDKT R/L-KG6C t max:25 | 73 € | KGM.. 6C | |



| Size Designation | Master Insert* | Spare Parts | |
|------------------|---|--|---|
| |  | Screw | Allen Key |
| 1212 | KGM (2C) |  BKTV M5x17-9211 |  SAK-AA4-9903 |
| 1616 | KGM (3C) | BKTV M6x25-9215 | |
| 2020 - 2525 | KGM (2C) | BKTV M6x25-9215 | |
| 2020 - 2525 | KGM (3C - 6C) | BKTV M8x1x25-9232 | |



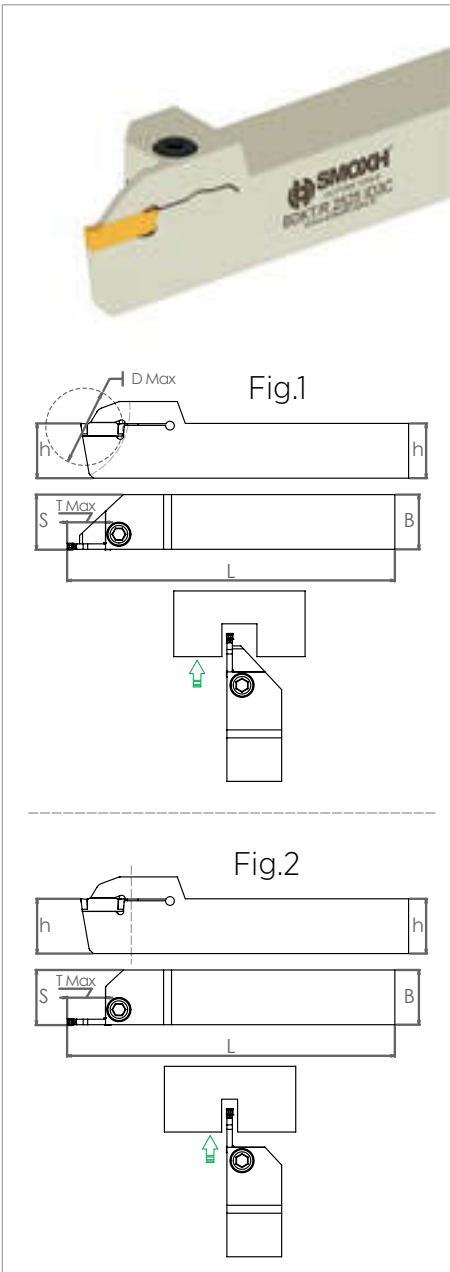

| Ordering Code | | Item Designation | Price | Master Insert* |
|---------------|---------|--------------------------------|-------|---|
| Direction | | BDKT R/L DGN / GRIP | EURO |  |
| Right | Left | | | |
| SM56220 | SM56237 | 2525 BDKT R/L-ID3C t max:22-JC | 135 € | DGN. 3C |
| SM56244 | SM56251 | 2525 BDKT R/L-IG4C t max:22-JC | 135 € | GRIP 4C |





| Ordering Code | | Item Designation | Price | | Master Insert* |
|---------------|---------|---------------------------------|-------|-------|---|
| Direction | | BDKT R/L DGN / GRIP / GIM / TGM | Fig. | EURO |  |
| Right | Left | | | | |
| SM09066 | SM09196 | 1212 BDKT R/L-ID2C t max:15 | 1 | 62 € | DGN. 2C |
| SM09059 | SM09172 | 1616 BDKT R/L-ID2C t max:18 | 1 | 67 € | |
| SM09035 | SM09189 | 2020 BDKT R/L-ID2C t max:18 | 1 | 69 € | DGN. 2.2C |
| SM09042 | SM09202 | 2525 BDKT R/L-ID2C t max:18 | 1 | 73 € | |
| SM47969 | SM47976 | 2020 BDKT R/L-ID2.2C t max:18 | 1 | 69 € | DGN. 3C |
| SM27787 | SM52024 | 2525 BDKT R/L-ID2.2C t max:18 | 1 | 73 € | |
| SM09103 | SM09233 | 1212 BDKT R/L-ID3C t max:15 | 1 | 62 € | DGN. 3C |
| SM09097 | SM09219 | 1616 BDKT R/L-ID3C t max:18 | 1 | 67 € | |
| SM09073 | SM09226 | 2020 BDKT R/L-ID3C t max:20 | 1 | 69 € | DGN. 3C |
| SM57333 | SM57340 | 2020 BDKT R/L-ID3C-T t max:20 | 2 | 69 € | |
| SM09080 | SM09240 | 2525 BDKT R/L-ID3C t max:22 | 1 | 73 € | DGN. 3C |
| SM57357 | SM57364 | 2525 BDKT R/L-ID3C-T t max:22 | 2 | 73 € | |
| SM57296 | SM57302 | 2525 BDKT R/L-ID3C t max:25 | 1 | 83 € | DGN. 3C |
| SM57371 | SM57388 | 2525 BDKT R/L-ID3C-T t max:25 | 2 | 83 € | |
| SM57319 | SM57326 | 2525 BDKT R/L-ID3C t max:40 | 1 | 123 € | DGN. 3C |
| SM09110 | SM09257 | 3232 BDKT R/L-ID3C t max:22 | 1 | 83 € | |
| SM47983 | SM47990 | 1212 BDKT R/L-IG3C t max:15 | 1 | 62 € | GRIP 3C |
| SM48003 | SM48010 | 1616 BDKT R/L-IG3C t max:18 | 1 | 67 € | |
| SM48027 | SM48034 | 2020 BDKT R/L-IG3C t max:20 | 1 | 69 € | GRIP 3C |
| SM48041 | SM48058 | 2525 BDKT R/L-IG3C t max:22 | 1 | 73 € | |
| SM48065 | SM48072 | 3232 BDKT R/L-IG3C t max:22 | 1 | 83 € | GRIP 3C |
| SM09127 | SM09141 | 2020 BDKT R/L-IG4C t max:20 | 1 | 69 € | |
| SM57395 | SM57401 | 2020 BDKT R/L-IG4C-T t max:20 | 2 | 69 € | GRIP 4C |
| SM09134 | SM09264 | 2525 BDKT R/L-IG4C t max:22 | 1 | 73 € | |
| SM57456 | SM57463 | 2525 BDKT R/L-IG4C-T t max:22 | 2 | 73 € | GRIP 4C |
| SM57418 | SM57425 | 2525 BDKT R/L-IG4C t max:25 | 1 | 83 € | |
| SM57470 | SM57487 | 2525 BDKT R/L-IG4C-T t max:25 | 2 | 83 € | GRIP 4C |
| SM57432 | SM57449 | 2525 BDKT R/L-IG4C t max:40 | 1 | 123 € | |
| SM09158 | SM09271 | 3232 BDKT R/L-IG4C t max:22 | 1 | 83 € | GRIP 4C |
| SM09165 | SM09288 | 3232 BDKT R/L-IG5C t max:25 | 1 | 83 € | |
| SM38837 | SM38820 | 1616 BDKT R/L-IGM3C t max:15 | 1 | 67 € | GIM 3C |
| SM38806 | SM38813 | 2020 BDKT R/L-IGM3C t max:20 | 1 | 69 € | |
| SM38769 | SM38752 | 2525 BDKT R/L-ITG3C-T t max:22 | 2 | 73 € | TGM 3C |
| SM57739 | SM57777 | 2020 BDKT R/L-ITG3C-T t max:8 | 2 | 69 € | |
| SM57746 | SM57784 | 2525 BDKT R/L-ITG3C-T t max:8 | 2 | 73 € | TGM 3C |
| SM57753 | SM57791 | 2020 BDKT R/L-ITG4C-T t max:10 | 2 | 69 € | |
| SM57760 | SM57807 | 2525 BDKT R/L-ITG4C-T t max:16 | 2 | 73 € | TGM 4C |



| Size Designation | Master Insert* | Spare Parts | |
|------------------|---|--|--|
| |  | Screw  | Allen Key  |
| 1212 | DGN / GRIP (2C - 3C) | BKTV M5x17-9211 | SAK-AA4-9903 |
| 1616 | | BKTV M6x25-9215 | |
| 2020 - 3232 | DGN (2C - 2.2C) | BKTV M6x25-9215 | |
| 2020 - 3232 | DGN / GRIP / GIM / TGM (3C - 5C) | BKTV M8x1x25-9232 | |



*Suitable Insert brand is ISC.

|  | Ordering Code | | Item Designation | Price | Master Insert* |
|---|---------------|----------------------------|---------------------------------|-------------|---|
| | Direction | | <i>BDKT R/L TGTC TDC</i> | <i>EURO</i> |  |
| | Right | Left | | | |
| | SM10055 | SM10154 | 1212 BDKT R/L-T2C t max:15 | 62 € | TDC. 2C |
| | SM10062 | SM10161 | 1616 BDKT R/L-T2C t max:18 | 67 € | |
| | SM10079 | SM10178 | 2020 BDKT R/L-T2C t max:18 | 69 € | |
| | SM10086 | SM10185 | 2525 BDKT R/L-T2C t max:18 | 73 € | |
| | SM10093 | SM10192 | 1212 BDKT R/L-T3C t max:15 | 62 € | TDC. 3C |
| | SM10109 | SM10208 | 1616 BDKT R/L-T3C t max:18 | 67 € | |
| | SM10116 | SM10215 | 2020 BDKT R/L-T3C t max:20 | 69 € | |
| SM10123 | SM10222 | 2525 BDKT R/L-T3C t max:22 | 73 € | | |
| SM10130 | SM10239 | 2020 BDKT R/L-T4C t max:20 | 69 € | TDC. 4C | |
| SM10147 | SM10246 | 2525 BDKT R/L-T4C t max:22 | 73 € | | |



| Size Designation | Master Insert* | Spare Parts | |
|------------------|---|--|---|
| | | Screw | Allen Key |
| 1212 |  TDC(2C - 3C) |  BKTV M5x17-9211 |  SAK-AA4-9903 |
| 1616 | | BKTV M6x25-9215 | |
| 2020 - 2525 | TDC (2C) | BKTV M6x25-9215 | |
| 2020 - 2525 | TDC(3C - 4C) | BKTV M8x1x25-9232 | |



*Suitable Insert brand is TGTC.

|  | Ordering Code | | Item Designation | Price | Master Insert* |
|---|---------------|---------|--------------------------------|-------------|---|
| | Direction | | <i>BDKT R/L KYC GDM</i> | <i>EURO</i> |  |
| | Right | Left | | | |
| | SM45231 | SM45248 | 2020 BDKT R/L KYC2C t max:18 | 69 € | GDM 2020 |
| | SM45255 | SM45262 | 2525 BDKT R/L KYC2C t max:18 | 73 € | GDM 3020 |
| | SM45279 | SM45286 | 2020 BDKT R/L KYC3C t max:20 | 69 € | |
| | SM45293 | SM45309 | 2525 BDKT R/L KYC3C t max:22 | 73 € | |
| | SM45316 | SM45323 | 2020 BDKT R/L KYC4C t max:20 | 69 € | |
| | SM45330 | SM45347 | 2525 BDKT R/L KYC4C t max:22 | 73 € | GDM 4020 |



| Size Designation | Master Insert* | Spare Parts | |
|------------------|---|--|---|
| | | Screw | Allen Key |
| 2020 - 2525 |  GDM (2C) |  BKTV M6x25-9215 |  SAK-AA4-9903 |
| 2020 - 2525 | GDM (3C - 4C) | BKTV M8x1x25-9232 | |



*Suitable Insert brand is KYCR.

|  | Ordering Code | | Item Designation | Price | Master Insert* |
|---|---------------|------------------------------|------------------------------|-------|---|
| | Direction | | BDKT R/L ZCC-CT ZT.. | EURO |  |
| | Right | Left | | | |
| | SM10277 | SM10376 | 1616 BDKT/R ZCC2-2C t max:18 | 67 € | ZTDB 2C |
| | SM10253 | SM10352 | 2020 BDKT/R ZCC2-2C t max:18 | 69 € | |
| | SM10260 | SM10369 | 2525 BDKT/R ZCC2-2C t max:18 | 73 € | ZTFD 3C |
| | SM10307 | SM10406 | 1616 BDKT/R ZCC2-3C t max:18 | 67 € | |
| | SM10284 | SM10383 | 2020 BDKT/R ZCC2-3C t max:20 | 69 € | ZTGD 4C |
| | SM10291 | SM10390 | 2525 BDKT/R ZCC2-3C t max:22 | 73 € | |
| | SM10314 | SM10413 | 2020 BDKT/R ZCC2-4C t max:20 | 69 € | ZTHD 5C |
| SM10321 | SM10420 | 2525 BDKT/R ZCC2-4C t max:22 | 73 € | | |
| SM10338 | SM10437 | 2020 BDKT/R ZCC2-5C t max:22 | 69 € | | |
| SM10345 | SM10444 | 2525 BDKT/R ZCC2-5C t max:25 | 73 € | | |



| Size Designation | Master Insert* | Spare Parts | |
|------------------|--|---|---|
| | | Screw | Allen Key |
| 1212 |  ZT..(2C - 3C) |  BKT V M5x17-9211 |  SAK-AA4-9903 |
| 1616 | | BKT V M6x25-9215 | |
| 2020 - 2525 | ZT.. (2C) | BKT V M6x25-9215 | |
| 2020 - 2525 | ZT.. (3C - 5C) | BKT V M8x1x25-9232 | |

*Suitable Insert brand is ZCC-CT.







|  | Ordering Code | | Item Designation | Price | Master Insert** |
|---|---------------|---------|---------------------------------|-------|---|
| | Direction | | BDKT R/L LMN GCTX | EURO |  |
| | Right | Left | | | |
| | SM25158 | SM24960 | 1616 BDKT R/L-GC-LM-2C t max:18 | 67 € | GCTX 2C |
| | SM24946 | SM24922 | 2020 BDKT R/L-GC-LM-2C t max:18 | 69 € | |
| | SM24908 | SM24885 | 2525 BDKT R/L-GC-LM-2C t max:18 | 73 € | GCTX 3C |
| | SM24977 | SM24953 | 1616 BDKT R/L-GC-LM-3C t max:18 | 67 € | |
| | SM24939 | SM24915 | 2020 BDKT R/L-GC-LM-3C t max:20 | 69 € | |
| | SM24892 | SM24878 | 2525 BDKT R/L-GC-LM-3C t max:22 | 73 € | |



| Size Designation | Master Insert** | Spare Parts | |
|------------------|---|---|---|
| | | Screw | Allen Key |
| 1616 |  GCTX (2C - 3C) |  BKT V M6x25-9215 |  SAK-AA4-9903 |
| 2020 - 2525 | | BKT V M6x25-9215 | |
| 2020 - 2525 | GCTX (2C) | BKT V M6x25-9215 | |
| 2020 - 2525 | GCTX (3C) | BKT V M8x1x25-9232 | |

*Suitable Insert brand is LMN.

|  | Ordering Code | | Item Designation | Price | Master Insert* |
|---|---------------|---------|-------------------------------------|-------|---|
| | Direction | | BDKT R/L SDV123 | EURO |  |
| | Right | Left | | | |
| | SM56268 | SM56275 | 2525 BDKT R/L-SDV123-3C t max:22-JC | 135 € | 123-3C |
| | SM56282 | SM56299 | 2525 BDKT R/L-SDV123-4C t max:22-JC | 135 € | 123-4C |

Cooling accessories are optional / See Page 297 for cooling accessory.
Soğutma ekipmanları opsiyoneldir / Bkz. Sayfa 297 Soğutma aksesuarları için

|  | Ordering Code | | Item Designation | Price | Master Insert* |
|--|---------------|---------|--|-------|---|
| | Direction | | BDKT R/L SDV123 | EURO |  |
| | Right | Left | | | |
| | SM38707 | SM38691 | 1212 BDKT R/L-SDV123-2C t max:15 | 62 € | 123-2C |
| | SM09875 | SM09950 | 1616 BDKT R/L-SDV123-2C t max:18 | 67 € | |
| | SM09851 | SM09967 | 2020 BDKT R/L-SDV123-2C t max:18 | 69 € | |
| | SM09868 | SM09974 | 2525 BDKT R/L-SDV123-2C t max:18 | 73 € | 123-3C |
| | SM38677 | SM38684 | 1212 BDKT R/L-SDV123-3C t max:15 | 62 € | |
| | SM09899 | SM10000 | 1616 BDKT R/L-SDV123-3C t max:18 | 67 € | |
| | SM09882 | SM09998 | 2020 BDKT R/L-SDV123-3C t max:20 | 69 € | 123-4C |
| | SM09905 | SM09981 | 2525 BDKT R/L-SDV123-3C t max:22 | 73 € | |
| | SM57814 | SM57838 | 2525 BDKT R/L-SDV123-3C t max:25  | 0 € | |
| | SM57821 | SM57845 | 2525 BDKT R/L-SDV123-3C t max:40  | 0 € | 123-5C |
| | SM09912 | SM10017 | 2020 BDKT R/L-SDV123-4C t max:20 | 69 € | |
| | SM09929 | SM10024 | 2525 BDKT R/L-SDV123-4C t max:22 | 73 € | |
| | SM57852 | SM57876 | 2525 BDKT R/L-SDV123-4C t max:25  | 83 € | 123-5C |
| | SM57869 | SM57883 | 2525 BDKT R/L-SDV123-4C t max:40  | 123 € | |
| | SM09936 | SM10031 | 2020 BDKT R/L-SDV123-5C t max:22 | 69 € | |
| | SM09943 | SM10048 | 2525 BDKT R/L-SDV123-5C t max:25 | 73 € | |

| Size Designation | Master Insert* | Spare Parts | |
|------------------|----------------|---|---|
| | | Screw | Allen Key |
| | |  |  |
| 1212 | 123 (2C - 3C) | BKTV M5x17-9211 | SAK-AA4-9903 |
| 1616 | 123 (2C - 5C) | BKTV M6x25-9215 | |
| 2020 - 2525 | 123 (2C) | BKTV M6x25-9215 | |
| 2020 - 2525 | 123 (3C - 5C) | BKTV M8x1x25-9232 | |

*Suitable Insert brand is SDVK.





| Ordering Code | | Item Designation | Price | Master Insert* |
|---------------|---------|-------------------------------------|-------|---|
| Direction | | BDKT R/L SDV151.2 | EURO |  |
| Right | Left | | | |
| SM48089 | SM48096 | 1616 BDKT R/L SDV 151.2 2C t max:18 | 67 € | 151.2-2C |
| SM48102 | SM48119 | 2020 BDKT R/L SDV 151.2 2C t max:18 | 69 € | |
| SM48126 | SM48133 | 2525 BDKT R/L SDV 151.2 2C t max:18 | 73 € | 151.2-3C |
| SM48140 | SM48157 | 1616 BDKT R/L SDV 151.2 3C t max:18 | 67 € | |
| SM48164 | SM48171 | 2020 BDKT R/L SDV 151.2 3C t max:20 | 69 € | 151.2-4C |
| SM48188 | SM48195 | 2525 BDKT R/L SDV 151.2 3C t max:22 | 73 € | |
| SM48201 | SM48218 | 1616 BDKT R/L SDV 151.2 4C t max:18 | 67 € | 151.2-5C |
| SM48225 | SM48232 | 2020 BDKT R/L SDV 151.2 4C t max:20 | 69 € | |
| SM48256 | SM48263 | 2525 BDKT R/L SDV 151.2 4C t max:22 | 73 € | 151.2-5C |
| SM48294 | SM48300 | 2020 BDKT R/L SDV 151.2 5C t max:20 | 69 € | |
| SM48287 | SM48270 | 2525 BDKT R/L SDV 151.2 5C t max:25 | 73 € | |

| Size Designation | Master Insert* | Spare Parts | |
|------------------|---|-------------------|--------------|
| |  | Screw | Allen Key |
| 1616 | 151.2 (2C - 5C) | BKTV M6x25-9215 | SAK-AA4-9903 |
| 2020 - 2525 | 151.2 (2C) | BKTV M6x25-9215 | |
| 2020 - 2525 | 151.2 (3C - 5C) | BKTV M8x1x25-9232 | |

*Suitable Insert brand is SDVK.







| Ordering Code | | Item Designation | Price | Master Insert* |
|---------------|---------|---|-------|---|
| Direction | | BDKT R/L WLTR/CRTZ ..GX16 / ..GX24 | EURO |  |
| Right | Left | | | |
| SM45811 | SM45828 | 2020 BDKT R/L 2GX16 t max:18 | 69 € | 2GX16 |
| SM45897 | SM45903 | 2525 BDKT R/L 2GX16 t max:18 | 73 € | 3GX16 |
| SM45835 | SM45842 | 2020 BDKT R/L 3GX16 t max:20 | 69 € | |
| SM45910 | SM45927 | 2525 BDKT R/L 3GX16 t max:22 | 73 € | 2GX24 |
| SM45859 | SM45866 | 2020 BDKT R/L 2GX24 t max:18 | 69 € | |
| SM45934 | SM45941 | 2525 BDKT R/L 2GX24 t max:18 | 73 € | 3GX24 |
| SM45873 | SM45880 | 2020 BDKT R/L 3GX24 t max:20 | 69 € | |
| SM45958 | SM45965 | 2525 BDKT R/L 3GX24 t max:22 | 73 € | 4GX24 |
| SM45972 | SM45989 | 2525 BDKT R/L 4GX24 t max:22 | 73 € | |

| Size Designation | Master Insert* | Spare Parts | |
|------------------|---|-------------------|--------------|
| |  | Screw | Allen Key |
| 2020 - 2525 | ..GX16 - ..GX24 (2C) | BKTV M6x25-9215 | SAK-AA4-9903 |
| 2020 - 2525 | ..GX16 - ..GX24 (3C - 4C) | BKTV M8x1x25-9232 | |



*Suitable Insert brand is WLTR/CRTZ.



External Parting and Grooving Tools

|  | Ordering Code | | Item Designation | Price | Master Insert* |
|---|---------------|----------------------------------|----------------------------------|-------|---|
| | Direction | | BDKT R/L HRN S229 | EURO |  |
| | Right | Left | | | |
| | SM08878 | SM08953 | 2020 BDKT R/L-H-S229-2C t max:18 | 69 € | S229-2C |
| | SM08885 | SM08960 | 2525 BDKT R/L-H-S229-2C t max:18 | 73 € | |
| | SM08892 | SM08977 | 2020 BDKT R/L-H-S229-3C t max:20 | 69 € | S229-3C |
| | SM08908 | SM08984 | 2525 BDKT R/L-H-S229-3C t max:22 | 73 € | |
| | SM08915 | SM08991 | 2020 BDKT R/L-H-S229-4C t max:20 | 69 € | S229-4C |
| | SM08922 | SM09004 | 2525 BDKT R/L-H-S229-4C t max:22 | 73 € | |
| | SM08946 | SM09011 | 2020 BDKT R/L-H-S229-5C t max:20 | 69 € | S229-5C |
| SM08939 | SM09028 | 2525 BDKT R/L-H-S229-5C t max:25 | 73 € | | |



| Size Designation | Master Insert* | Spare Parts | |
|------------------|---|---|--|
| |  | Screw | Allen Key |
| 2020 - 2525 | S229 (2C) |  BKTV M6x25-9215 |  SAK-AA4-9903 |
| 2020 - 2525 | S229 (3C - 5C) | BKTV M8x1x25-9232 | |



*Suitable Insert brand is HRN.

|  | Ordering Code | | Item Designation | Price | Master Insert* |
|---|---------------|-----------------------------------|-----------------------------------|-------|---|
| | Direction | | BDKT R/L K.HRN S224 | EURO |  |
| | Right | Left | | | |
| | SM09295 | SM09370 | 2020 BDKT R/L-HK-S224-2C t max:18 | 69 € | S224-2C |
| | SM09301 | SM09387 | 2525 BDKT R/L-HK-S224-2C t max:18 | 73 € | |
| | SM09318 | SM09394 | 2020 BDKT R/L-HK-S224-3C t max:20 | 69 € | S224-3C |
| | SM09325 | SM09400 | 2525 BDKT R/L-HK-S224-3C t max:22 | 73 € | |
| | SM09332 | SM09417 | 2020 BDKT R/L-HK-S224-4C t max:20 | 69 € | S224-4C |
| | SM09349 | SM09424 | 2525 BDKT R/L-HK-S224-4C t max:22 | 73 € | |
| | SM09356 | SM09431 | 2020 BDKT R/L-HK-S224-5C t max:20 | 69 € | S224-5C |
| SM09363 | SM09448 | 2525 BDKT R/L-HK-S224-5C t max:25 | 73 € | | |



| Size Designation | Master Insert* | Spare Parts | |
|------------------|---|---|--|
| |  | Screw | Allen Key |
| 2020 - 2525 | S224 (2C) |  BKTV M6x25-9215 |  SAK-AA4-9903 |
| 2020 - 2525 | S224 (3C - 5C) | BKTV M8x1x25-9232 | |



*Suitable Insert brand is HRN.

|  | Ordering Code | | Item Designation | Price | Master Insert* |
|---|---------------|----------------------------------|----------------------------------|-------|---|
| | Direction | | <i>BDKT R/L SMTM GCM</i> | EURO |  |
| | Right | Left | | | |
| | SM24762 | SM24717 | 1212 BDKT R/L-SM-GCM-2C t max:15 | 62 € | GCM-2C |
| | SM24847 | SM24823 | 1616 BDKT R/L-SM-GCM-2C t max:18 | 67 € | |
| | SM24793 | SM24786 | 2020 BDKT R/L-SM-GCM-2C t max:18 | 69 € | |
| | SM24755 | SM24731 | 2525 BDKT R/L-SM-GCM-2C t max:18 | 73 € | |
| | SM24861 | SM24854 | 1212 BDKT R/L-SM-GCM-3C t max:15 | 62 € | GCM-3C |
| | SM24830 | SM24816 | 1616 BDKT R/L-SM-GCM-3C t max:15 | 67 € | |
| | SM24809 | SM24779 | 2020 BDKT R/L-SM-GCM-3C t max:20 | 69 € | |
| SM24748 | SM24724 | 2525 BDKT R/L-SM-GCM-3C t max:22 | 73 € | | |

| Size Designation | Master Insert* | Spare Parts | |
|------------------|---|-------------------|---|
| |  | Screw | Allen Key |
| 1212 | GCM (2C - 3C) | BKTV M5x17-9211 |  SAK-AA4-9903 |
| 1616 | GCM (2C - 3C) | BKTV M6x25-9215 | |
| 2020 - 2525 | GCM (2C) | BKTV M6x25-9215 | |
| 2020 - 2525 | GCM (3C) | BKTV M8x1x25-9232 | |

*Suitable Insert brand is SMTM.

|  | Ordering Code | | Item Designation | Price | Master Insert* |
|---|---------------|---------|--|-------|---|
| | Direction | | <i>BDKT R/L TNGLY DGM / DTX</i> | EURO |  |
| | Right | Left | | | |
| | SM57494 | SM57555 | 2020 BDKT R/L-DG2C t max:18 | 69 € | DGM / DTX 2C |
| | SM57500 | SM57562 | 2525 BDKT R/L-DG2C t max:18 | 73 € | |
| | SM57517 | SM57579 | 2020 BDKT R/L-DG3C t max:20 | 69 € | DGM / DTX 3C |
| | SM57524 | SM57586 | 2525 BDKT R/L-DG3C t max:22 | 73 € | |
| | SM57531 | SM57593 | 2020 BDKT R/L-DG4C t max:20 | 69 € | DGM / DTX 4C |
| | SM57548 | SM57609 | 2525 BDKT R/L-DG4C t max:22 | 73 € | |

| Size Designation | Master Insert* | Spare Parts | |
|------------------|---|-------------------|---|
| |  | Screw | Allen Key |
| 2020 - 2525 | DTM / DTX (2C) | BKTV M6x25-9215 |  SAK-AA4-9903 |
| 2020 - 2525 | DTM / DTX (3C - 4C) | BKTV M8x1x25-9232 | |

*Suitable Insert brand is TNGLY.

External Parting and Grooving Tools



| Ordering Code | | Item Designation | Price | Master Insert* |
|------------------|-------------|------------------------------|-------------|----------------|
| <i>Direction</i> | | BDKT R/L KNMTL A4 | EURO | |
| <i>Right</i> | <i>Left</i> | | | |
| SM57616 | SM57678 | 2020 BDKT R/L-A4-2C t max:18 | 69 € | A4 2C |
| SM57623 | SM57685 | 2525 BDKT R/L-A4-2C t max:18 | 73 € | A4 2C |
| SM57630 | SM57692 | 2020 BDKT R/L-A4-3C t max:20 | 69 € | A4 3C |
| SM57647 | SM57708 | 2525 BDKT R/L-A4-3C t max:22 | 73 € | A4 3C |
| SM57654 | SM57715 | 2020 BDKT R/L-A4-4C t max:20 | 69 € | A4 4C |
| SM57661 | SM57722 | 2525 BDKT R/L-A4-4C t max:22 | 73 € | A4 4C |

| Size Designation | Master Insert* | Spare Parts | |
|------------------|----------------|--------------------|--------------|
| | | Screw | Allen Key |
| | | | |
| 2020 - 2525 | A4 (2C) | BKT V M6x25-9215 | SAK-AA4-9903 |
| 2020 - 2525 | A4 (3C - 4C) | BKT V M8x1x25-9232 | |

*Suitable Insert brand is KNMTL.



| Ordering Code | | Item Designation | Price | Master Insert* |
|------------------|-------------|---|-------------|----------------|
| <i>Direction</i> | | BDKT R/L TGTC TDC SWISS TYPE | EURO | |
| <i>Right</i> | <i>Left</i> | | | |
| SM48430 | SM48447 | 1010 BDKT R/L T2C K.O t max:10 | 62 € | TDC 2C |
| SM39605 | SM48454 | 1212 BDKT R/L T2C K.O t max:10 | 62 € | |
| SM48461 | SM48478 | 1616 BDKT R/L T2C K.O t max:16 | 67 € | |

| Size Designation | Master Insert* | Spare Parts | |
|------------------|----------------|------------------|--------------|
| | | Screw | Allen Key |
| | | | |
| 1010 - 1212 | TDC (2C) | SSV M3.5x14-9512 | STK-T15-9910 |
| 1616 | | SSV M4x14-9516 | |



*Suitable Insert brand is TGTC.







| Ordering Code | | Item Designation | Price | Master Insert* |
|------------------|-------------|------------------------------------|-------------|----------------|
| <i>Direction</i> | | BDKT R/L DGN SWISS TYPE | EURO | |
| <i>Right</i> | <i>Left</i> | | | |
| SM40052 | SM40069 | 1212 BDKT R/L ID2C K.O t max:10 | 62 € | DGN 2C |
| SM40038 | SM40045 | 1616 BDKT R/L ID2C K.O t max:16 | 67 € | |
| SM38448 | SM38493 | 1010 BDKT R/L ID3C K.O t max:10 | 62 € | DGN 3C |
| SM38455 | SM38509 | 1212 BDKT R/L ID3C K.O t max:10 | 62 € | |
| SM38462 | SM38523 | 1616 BDKT R/L ID3C K.O t max:16 | 67 € | |



| Size Designation | Master Insert** | Spare Parts | |
|------------------|-----------------|------------------|--------------|
| | | Screw | Allen Key |
| | | | |
| 1010 - 1212 | DGN (2C - 3C) | SSV M3.5x14-9512 | STK-T15-9910 |
| 1616 | | SSV M4x14-9516 | |

**Suitable Insert brand is ISC.

|  | Ordering Code | | Item Designation | Price | Master Insert* |
|---|---------------|--------------------------------|---|-------|---|
| | Direction | | <i>BDKT R/L KRLY MGM. SWISS TYPE</i> | EURO |  |
| | Right | Left | | | |
| | SM48317 | SM48324 | 1010 BDKT R/L K2C K.O t max:10 | 62 € | MGM. 2C |
| | SM48331 | SM48348 | 1212 BDKT R/L K2C K.O t max:10 | 62 € | |
| | SM48362 | SM48355 | 1616 BDKT R/L K2C K.O t max:16 | 67 € | |
| | SM48386 | SM48379 | 1010 BDKT R/L K3C K.O t max:10 | 62 € | MGM. 3C |
| | SM48393 | SM48409 | 1212 BDKT R/L K3C K.O t max:10 | 62 € | |
| SM48416 | SM48423 | 1616 BDKT R/L K3C K.O t max:16 | 67 € | | |

| Size Designation | Master Insert* | Spare Parts | |
|------------------|---|---|---|
| |  | Screw | Allen Key |
| 1010 - 1212 | MGM. (2C - 3C) |  |  |
| 1616 | | SSV M3.5x14-9512 | |
| | | SSV M4x14-9516 | STK-T15-9910 |

|  | Ordering Code | | Item Designation | Price | Master Insert* |
|--|---------------|---------|---|-------|--|
| | Direction | | <i>BDKT R/L KRLY KGM. SWISS TYPE</i> | EURO |  |
| | Right | Left | | | |
| | SM38363 | SM38394 | 1010 BDKT R/L KGM2C K.O t max:10 | 62 € | KGM. 2C |
| | SM38370 | SM38400 | 1212 BDKT R/L KGM2C K.O t max:10 | 62 € | |
| | SM38387 | SM38417 | 1616 BDKT R/L KGM2C K.O t max:16 | 67 € | |



| Size Designation | Master Insert* | Spare Parts | |
|------------------|---|---|---|
| |  | Screw | Allen Key |
| 1010 - 1212 | KGM. (2C) |  |  |
| 1616 | | SSV M3.5x14-9512 | |
| | | SSV M4x14-9516 | STK-T15-9910 |

*Suitable Insert brand is KRLY.

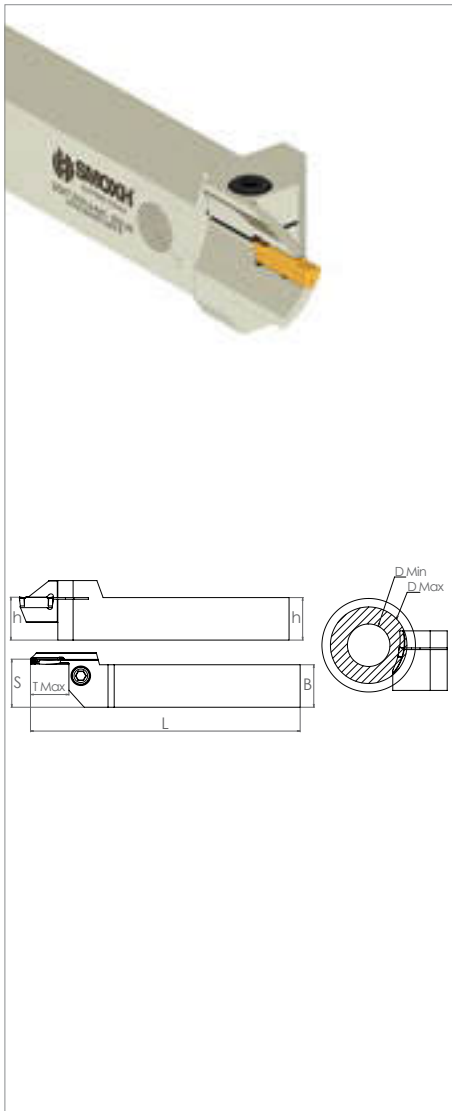
External Parting and Grooving Tools



| Ordering Code | Item Designation | Price | Master Insert* |
|------------------|-------------------------------------|-------------|---|
| <i>Direction</i> | A TYPE FACE GROOVING | | |
| <i>Right</i> | BDKT-A MGM. | <i>EURO</i> |  |
| SM10543 | 2525 BDKT-A K3C (Ø24-36) t max:17 | 102 € | MGM. 3C |
| SM10567 | 2525 BDKT-A K3C (Ø36-48) t max:17 | 102 € | |
| SM10550 | 2525 BDKT-A K3C (Ø48-70) t max:17 | 102 € | |
| SM10536 | 2525 BDKT-A K3C (Ø70-110) t max:17 | 102 € | |
| SM10512 | 2525 BDKT-A K3C (Ø100-150) t max:17 | 102 € | |
| SM10529 | 2525 BDKT-A K3C (Ø150-200) t max:17 | 102 € | |
| SM39643 | 2525 BDKT-A K3C (Ø200-350) t max:17 | 102 € | |
| SM39650 | 2525 BDKT-A K3C (Ø300-500) t max:17 | 102 € | |
| SM10581 | 2525 BDKT-A K4C (Ø24-36) t max:22 | 102 € | MGM. 4C |
| SM10604 | 2525 BDKT-A K4C (Ø36-48) t max:22 | 102 € | |
| SM10598 | 2525 BDKT-A K4C (Ø48-70) t max:22 | 102 € | |
| SM10574 | 2525 BDKT-A K4C (Ø70-110) t max:22 | 102 € | |
| SM10628 | 2525 BDKT-A K4C (Ø100-150) t max:22 | 102 € | |
| SM10611 | 2525 BDKT-A K4C (Ø150-200) t max:22 | 102 € | |
| SM39667 | 2525 BDKT-A K4C (Ø200-350) t max:22 | 102 € | |
| SM39674 | 2525 BDKT-A K4C (Ø300-500) t max:22 | 102 € | |
| SM10635 | 2525 BDKT-A K5C (Ø36-48) t max:25 | 102 € | MGM. 5C |
| SM10659 | 2525 BDKT-A K5C (Ø48-70) t max:25 | 102 € | |
| SM10666 | 2525 BDKT-A K5C (Ø70-110) t max:25 | 102 € | |
| SM10673 | 2525 BDKT-A K5C (Ø100-150) t max:25 | 102 € | |
| SM10680 | 2525 BDKT-A K5C (Ø150-200) t max:25 | 102 € | |
| SM39681 | 2525 BDKT-A K5C (Ø200-350) t max:25 | 102 € | |
| SM39803 | 2525 BDKT-A K5C (Ø300-500) t max:25 | 102 € | |



| Size Designation | Master Insert* | Spare Parts | |
|------------------|---|--|---|
| | | Screw | Allen Key |
| 2525 |  MGM (3C - 5C) |  BKTV M8x1x25-9232 |  SAK-AA4-9903 |

*Suitable Insert brand is KRLY.

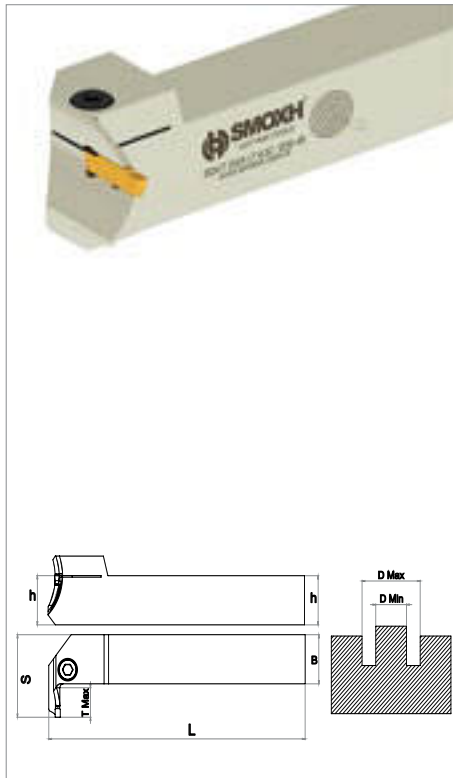
L AND A TYPE FACE GROOVING





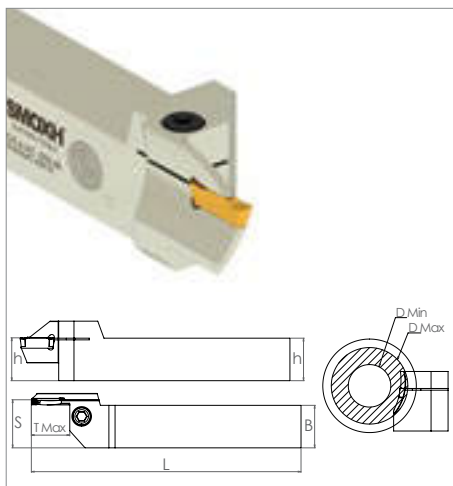

| Ordering Code | Item Designation | Price | Master Insert* |
|------------------|--------------------------------------|-------------|---|
| <i>Direction</i> | L TYPE FACE GROOVING | <i>EURO</i> |  |
| <i>Right</i> | BDKT-LT MGM. | | |
| SM37854 | 2525 BDKT-LT K3C (Ø24-36) t max:17 | 102 € | MGM. 3C |
| SM34624 | 2525 BDKT-LT K3C (Ø36-48) t max:17 | 102 € | |
| SM34631 | 2525 BDKT-LT K3C (Ø48-70) t max:17 | 102 € | |
| SM34648 | 2525 BDKT-LT K3C (Ø70-110) t max:17 | 102 € | |
| SM34655 | 2525 BDKT-LT K3C (Ø100-150) t max:17 | 102 € | |
| SM34662 | 2525 BDKT-LT K3C (Ø150-200) t max:17 | 102 € | |
| SM39766 | 2525 BDKT-LT K3C (Ø200-350) t max:17 | 102 € | |
| SM39773 | 2525 BDKT-LT K3C (Ø300-500) t max:17 | 102 € | |
| SM37861 | 2525 BDKT-LT K4C (Ø36-48) t max:20 | 102 € | MGM. 4C |
| SM37878 | 2525 BDKT-LT K4C (Ø48-70) t max:20 | 102 € | |
| SM34679 | 2525 BDKT-LT K4C (Ø70-110) t max:20 | 102 € | |
| SM34686 | 2525 BDKT-LT K4C (Ø100-150) t max:20 | 102 € | |
| SM34693 | 2525 BDKT-LT K4C (Ø150-200) t max:20 | 102 € | |
| SM39780 | 2525 BDKT-LT K4C (Ø200-350) t max:20 | 102 € | |
| SM39797 | 2525 BDKT-LT K4C (Ø300-500) t max:20 | 102 € | |

| Size Designation | Master Insert* | Spare Parts | |
|------------------|---|--|---|
| | | Screw | Allen Key |
| 2525 |  MGM (3C - 4C) |  BKTV M8x1x25-9232 |  SAK-AA4-9903 |

*Suitable Insert brand is KRLY.



| Ordering Code | Item Designation | Price | Master Insert* |
|------------------|-------------------------------------|-------------|---|
| <i>Direction</i> | A TYPE FACE GROOVING | <i>EURO</i> |  |
| <i>Right</i> | BDKT-A DGN | | |
| SM10505 | 2525 BDKT-A I4C (Ø24-36) t max:22 | 102 € | DGN. 4C |
| SM10468 | 2525 BDKT-A I4C (Ø36-48) t max:22 | 102 € | |
| SM10475 | 2525 BDKT-A I4C (Ø48-70) t max:22 | 102 € | |
| SM10482 | 2525 BDKT-A I4C (Ø70-110) t max:22 | 102 € | |
| SM10499 | 2525 BDKT-A I4C (Ø100-150) t max:22 | 102 € | |
| SM10451 | 2525 BDKT-A I4C (Ø150-200) t max:22 | 102 € | |
| SM39704 | 2525 BDKT-A I4C (Ø200-350) t max:22 | 102 € | |
| SM39711 | 2525 BDKT-A I4C (Ø300-500) t max:22 | 102 € | |

| Size Designation | Master Insert* | Spare Parts | |
|------------------|--|--|---|
| | | Screw | Allen Key |
| 2525 |  DGN (4C) |  BKTV M8x1x25-9232 |  SAK-AA4-9903 |

*Suitable Insert brand is ISCR.

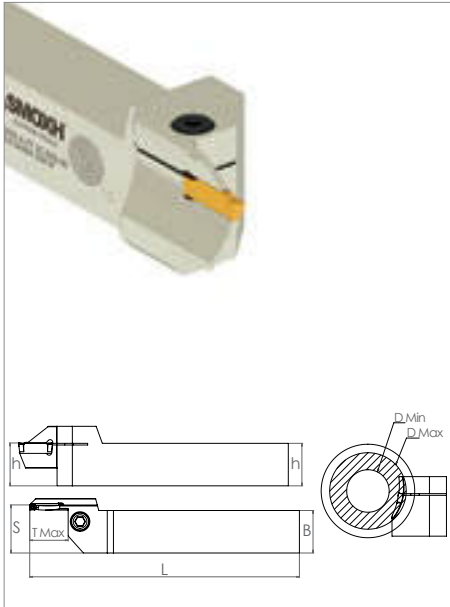

External Parting and Grooving Tools



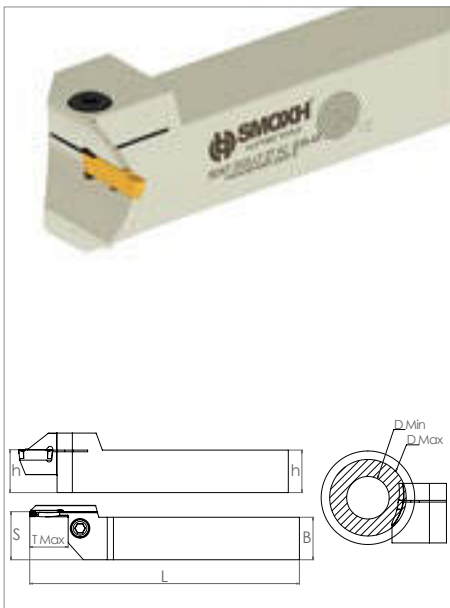





| Ordering Code | Item Designation | Price | Master Insert* | |
|------------------|---------------------------------------|-------------|---|---------|
| <i>Direction</i> | A TYPE FACE GROOVING | <i>EURO</i> |  | |
| <i>Right</i> | BDKT-A ZT.. ZCC-CT | | | |
| SM34402 | 2525 BDKT-A ZT 3C (Ø24-36) t max:17 | 102 € | ZTFD 3C | |
| SM34419 | 2525 BDKT-A ZT 3C (Ø36-48) t max:17 | 102 € | | |
| SM34426 | 2525 BDKT-A ZT 3C (Ø48-70) t max:17 | 102 € | | |
| SM34433 | 2525 BDKT-A ZT 3C (Ø70-110) t max:17 | 102 € | | |
| SM34440 | 2525 BDKT-A ZT 3C (Ø100-150) t max:17 | 102 € | | |
| SM34457 | 2525 BDKT-A ZT 3C (Ø150-200) t max:17 | 102 € | | |
| SM39810 | 2525 BDKT-A ZT 3C (Ø200-350) t max:17 | 102 € | ZTFD 3C | |
| SM39827 | 2525 BDKT-A ZT 3C (Ø300-500) t max:17 | 102 € | | |
| SM34464 | 2525 BDKT-A ZT 4C (Ø36-48) t max:22 | 102 € | | ZTFD 3C |
| SM34471 | 2525 BDKT-A ZT 4C (Ø48-70) t max:22 | 102 € | | |
| SM34488 | 2525 BDKT-A ZT 4C (Ø70-110) t max:22 | 102 € | | |
| SM34495 | 2525 BDKT-A ZT 4C (Ø100-150) t max:22 | 102 € | | |
| SM34501 | 2525 BDKT-A ZT 4C (Ø150-200) t max:22 | 102 € | | |
| SM39834 | 2525 BDKT-A ZT 4C (Ø200-350) t max:22 | 102 € | | |
| SM39841 | 2525 BDKT-A ZT 4C (Ø300-500) t max:22 | 102 € | | |
| | | | ZTFD 3C | |







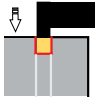
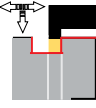
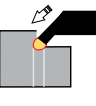

| Ordering Code | Item Designation | Price | Master Insert* | |
|------------------|--|-------------|---|---------|
| <i>Direction</i> | L TYPE FACE GROOVING | <i>EURO</i> |  | |
| <i>Right</i> | BDKT-LT ZT. ZCC-CT | | | |
| SM34518 | 2525 BDKT-LT ZT 3C (Ø24-36) t max:17 | 102 € | ZTFD 3C | |
| SM34525 | 2525 BDKT-LT ZT 3C (Ø36-48) t max:17 | 102 € | | |
| SM34532 | 2525 BDKT-LT ZT 3C (Ø48-70) t max:17 | 102 € | | |
| SM34549 | 2525 BDKT-LT ZT 3C (Ø70-110) t max:17 | 102 € | | |
| SM34556 | 2525 BDKT-LT ZT 3C (Ø100-150) t max:17 | 102 € | | |
| SM34563 | 2525 BDKT-LT ZT 3C (Ø150-200) t max:17 | 102 € | | |
| SM39728 | 2525 BDKT-LT ZT 3C (Ø200-350) t max:17 | 102 € | ZTFD 3C | |
| SM39735 | 2525 BDKT-LT ZT 3C (Ø300-500) t max:17 | 102 € | | |
| SM34570 | 2525 BDKT-LT ZT 4C (Ø36-48) t max:20 | 102 € | | ZTFD 3C |
| SM34587 | 2525 BDKT-LT ZT 4C (Ø48-70) t max:20 | 102 € | | |
| SM34594 | 2525 BDKT-LT ZT 4C (Ø70-110) t max:20 | 102 € | | |
| SM34600 | 2525 BDKT-LT ZT 4C (Ø100-150) t max:20 | 102 € | | |
| SM34617 | 2525 BDKT-LT ZT 4C (Ø150-200) t max:20 | 102 € | | |
| SM39742 | 2525 BDKT-LT ZT 4C (Ø200-350) t max:20 | 102 € | | |
| SM39759 | 2525 BDKT-LT ZT 4C (Ø300-500) t max:20 | 102 € | | |
| | | | ZTFD 3C | |

| Size Designation | Master Insert* | Spare Parts | |
|------------------|---|--|--|
| |  | Screw  | Allen Key  |
| 2525 | ZT.. (3C - 4C) | BKTV M8x1x25-9232 | SAK-AA4-9903 |





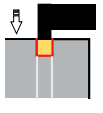
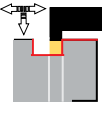
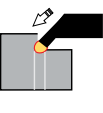

*Suitable Insert brand is ZCC-CT.

| Insert | | MGM. 1.5C KRLY | MGM. 2C KRLY | MGM. 3C KRLY | MGM. 4C KRLY | MGM. 5C KRLY | MGM. 5C KRLY |
|------------------|--------------------|---|---|---|---|---|---|
| | |  |  |  |  |  |  |
| Size (mm) | | Ø16 - 20 | Ø16 - 25 | Ø20 - 40 | Ø20 - 40 | Ø25 - 50 | Ø50 |
| Item Code | | BIKT R/L | BIKT R/L | BIKT R/L | BIKT R/L | BIKT R/L | BIKT R/L |
| T Max. (mm) | | 4-6mm | 4-7mm | 6-10mm | 7-15mm | 7-15mm | 15mm |
| Application Type | Internal Grooving |  | ✓ | ✓ | ✓ | ✓ | ✓ |
| | Page | | D103 | D103 | D103 | D103 | D103 |
| | Internal Turning |  | - | - | - | - | - |
| | Page | | | | | | |
| | Int. Edge Grooving |  | - | - | - | - | - |
| | Page | | | | | | |





| Insert | | MGM. 6C KRLY | KGM. 2C KRLY | KGM. 3C KRLY | KGM. 4C KRLY | MRM. 3C KRLY | MRM. 4C KRLY |
|------------------|--------------------|---|---|---|---|---|---|
| | |  |  |  |  |  |  |
| Size (mm) | | Ø50 | Ø20 - 25 | Ø25 - 32 | Ø25 - 32 | Ø25 - 40 | Ø25 - 40 |
| Item Code | | BIKT R/L | BIKT R/L | BIKT R/L | BIKT R/L | BIRT R/L | BIRT R/L |
| T Max. (mm) | | 15mm | 6-7mm | 7-8mm | 7-8mm | 3.5mm | 3.5mm |
| Application Type | Internal Grooving |  | ✓ | ✓ | ✓ | - | - |
| | Page | | D103 | D104 | D104 | | |
| | Internal Turning |  | - | ✓ | ✓ | ✓ | - |
| | Page | | | D104 | D104 | D104 | |
| | Int. Edge Grooving |  | - | - | - | - | ✓ |
| | Page | | | | | D104 | D104 |

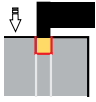
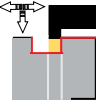
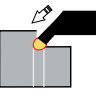







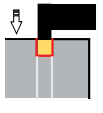
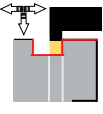
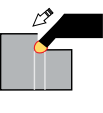

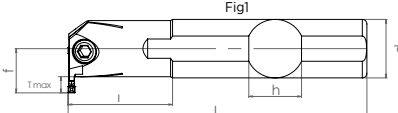
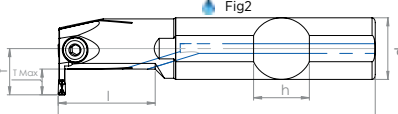
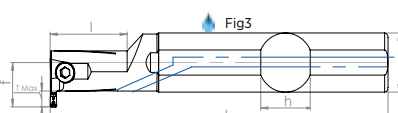



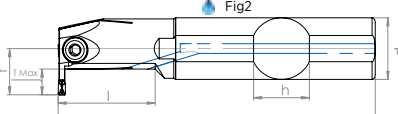

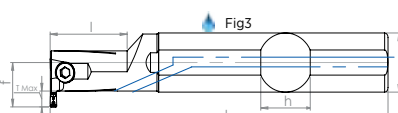
| Insert | | MRM. 5C KRLY | GRIP 3C | GRIP 4C | DGN 3C | GEPI 3C | GEPI 4C | TDC. 2C TGTC | TDC. 3C TGTC |
|------------------|--------------------|---|-------------|---|---|---|---|--|---|
| | | | |  |  |  |  |  |  |
| Size (mm) | | Ø32 - 40 | Ø16 - 25 | Ø25 - 32 | Ø20 - 32 | Ø10 - 16 | Ø10 - 16 | Ø20 - 25 | Ø20 - 32 |
| Item Code | | BIRT R/L | BIKT R/L | BIKT R/L | BIKT R/L | BEKT R/L | BEKT R/L | BIKT R/L | BIKT R/L |
| T Max. (mm) | | 3.5mm | 4-7mm | 7-8mm | 6-8mm | 2.6mm | 2.6-4mm | 6-7mm | 6-8mm |
| Application Type | Internal Grooving |  | - | ✓ | ✓ | ✓ | ✓ | ✓ | ✓ |
| | Page | | D105 | D105 | D105 | D105 | D105 | D107 | D107 |
| | Internal Turning |  | - | - | - | - | | - | - |
| | Page | | | | | | | | |
| | Int. Edge Grooving |  | ✓ | - | - | - | | - | - |
| | Page | | D104 | | | | | | |

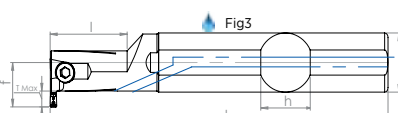
| Insert | | TDC. 4C TGTC | S224 2C HORN | S224 3C HORN | S224 4C HORN | S229 3C HORN | S229 4C HORN |
|------------------|--------------------|---|--------------|---|---|---|---|
| | | | |  |  |  |  |
| Size (mm) | | Ø20 - 32 | Ø20 - 25 | Ø20 - 32 | Ø20 - 32 | Ø25 - 50 | Ø50 |
| Item Code | | BIKT R/L | BIKT R/L | BIKT R/L | BIKT R/L | BIKT R/L | BIKT R/L |
| T Max. (mm) | | 6-8mm | 6-7mm | 7-8mm | 7-8mm | 7-15mm | 15mm |
| Application Type | Internal Grooving |  | ✓ | ✓ | ✓ | ✓ | ✓ |
| | Page | | D107 | D106 | D106 | D106 | D106 |
| | Internal Turning |  | - | - | - | | - |
| | Page | | | | | | |
| | Int. Edge Grooving |  | - | - | - | - | - |
| | Page | | | | | | |

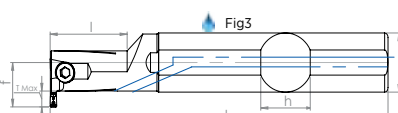
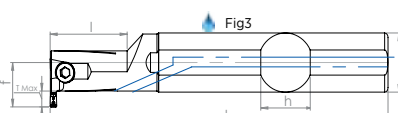

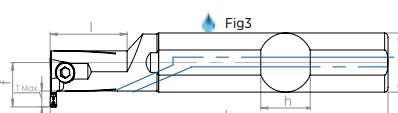
| Insert | | S229 5C HORN | 123 2C SDV | 123 3C SDV | 123 4C SDV | GDM 2C KYC | GDM 3C KYC |
|------------------|--------------------|---|---|---|---|---|---|
| | |  |  |  |  |  |  |
| Size (mm) | | Ø25 - 32 | Ø20 - 25 | Ø20 - 32 | Ø20 - 32 | Ø20 - 25 | Ø20 - 32 |
| Item Code | | BIKT R/L | BIKT R/L | BIKT R/L | BIKT R/L | BIKT R/L | BIKT R/L |
| T Max. (mm) | | 7-10mm | 6-7mm | 6-8mm | 6-8mm | 6-7mm | 6-8mm |
| Application Type | Internal Grooving |  | ✓ | ✓ | ✓ | ✓ | ✓ |
| | Page | | D106 | D106 | D106 | D107 | D107 |
| | Internal Turning |  | - | - | - | - | - |
| | Page | | | | | | |
| | Int. Edge Grooving |  | - | - | - | - | - |
| | Page | | | | | | |

| Insert | | GDM 4C KYC | ZTBD 2C ZCC | ZTFD 3C ZCC | ZTGD 4C ZCC | ZTHD 5C ZCC | - |
|------------------|--------------------|---|---|---|---|---|---|
| | |  |  |  |  |  | - |
| Size (mm) | | Ø20 - 32 | Ø20 | Ø20 - 32 | Ø25 - 40 | Ø32 - 40 | - |
| Item Code | | BIKT R/L | BIKT R/L | BIKT R/L | BIKT R/L | BIKT R/L | - |
| T Max. (mm) | | 6-8mm | 6mm | 6-8mm | 7-10mm | 8-10mm | - |
| Application Type | Internal Grooving |  | ✓ | ✓ | ✓ | ✓ | - |
| | Page | | D107 | D108 | D108 | D108 | |
| | Internal Turning |  | - | - | - | - | - |
| | Page | | | | | | |
| | Int. Edge Grooving |  | - | - | - | - | - |
| | Page | | | | | | |

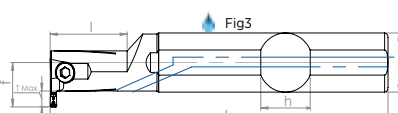
| Insert | | NF..08 KRLY | NF..11 KRLY | NF..14 KRLY | NF..16 KRLY | MB09 SDV | - |
|------------------|--------------------|---|---|---|---|---|---|
| | |  |  |  |  |  | |
| Size (mm) | | Ø12 | Ø16 | Ø16 | Ø16 | Ø16 | - |
| Item Code | | BIKT | BIKT R/L | BIKT R/L | BIKT R/L | BIKT R/L | - |
| T Max. (mm) | | From Insert | From Insert | From Insert | From Insert | From Insert | - |
| Application Type | Internal Grooving |  | ✓ | ✓ | ✓ | ✓ | - |
| | Page | | D108 | D108 | D108 | D108 | |
| | Internal Turning |  | ✓ | ✓ | ✓ | ✓ | - |
| | Page | | D108 | D108 | D108 | D108 | |
| | Int. Edge Grooving |  | - | - | - | - | - |
| | Page | | | | | | |

|  | Ordering Code | | Item Designation | Price | Fig. | Master Insert* |
|--|---------------|---------|--|-------|------|----------------|
| | Direction | | | | | |
| | Right | Left | BIKT R/L MGM.-KRLY | | EURO | |
|  | SM51478 | SM51485 | BIKT R/L 16-K1.5C t max:4 | 62 € | 1 | MGM. 1.5C |
| | SM51522 | SM51515 | BIKT R/L 20-K1.5C t max:6 | 65 € | 1 | |
| | SM11151 | SM11298 | BIKT R/L 16-K2C t max:4 | 62 € | 1 | |
|  | SM11168 | SM11304 | BIKT R/L 20-K2C t max:6 | 65 € | 1 | MGM. 2C |
| | SM11175 | SM11311 | BIKT R/L 25-K2C t max:7 | 70 € | 1 | |
| | SM11199 | SM11335 | BIKT R/L 20-K3C t max:6 | 65 € | 1 | |
|  | SM11205 | SM11342 | BIKT R/L 25-K3C t max:7 | 70 € | 1 | MGM. 3C |
| | SM59597 | SM59641 | BEKT R/L 25-K3C t max:10-IJ   | 85 € | 2 | |
| | SM59603 | SM59658 | BEKT R/L 25-K3C t max:7 D25-IJ   | 85 € | 3 | |
|  | SM11182 | SM11359 | BIKT R/L 32-K3C t max:8 | 75 € | 1 | MGM. 3C |
| | SM59610 | SM59665 | BEKT R/L 32-K3C t max:10-IJ   | 105 € | 2 | |
| | SM11212 | SM11328 | BIKT R/L 40-K3C t max:10 | 105 € | 1 | |
|  | SM11229 | SM11366 | BIKT R/L 20-K4C t max:6 | 62 € | 1 | MGM. 4C |
| | SM11236 | SM11373 | BIKT R/L 25-K4C t max:7 | 70 € | 1 | |
| | SM59627 | SM59672 | BEKT R/L 25-K4C t max:10-IJ   | 85 € | 2 | |
|  | SM11243 | SM11380 | BIKT R/L 32-K4C t max:8 | 75 € | 1 | MGM. 4C |
| | SM59634 | SM59689 | BEKT R/L 32-K4C t max:10-IJ   | 105 € | 2 | |
| | SM11250 | SM11397 | BIKT R/L 40-K4C t max:10 | 105 € | 1 | |
|  | SM25684 | SM25646 | BIKT R/L 50-K4C t max:15 | 265 € | 1 | MGM. 5C |
| | SM11267 | SM11403 | BIKT R/L 25-K5C t max:7 | 70 € | 1 | |
| | SM11274 | SM11410 | BIKT R/L 32-K5C t max:8 | 75 € | 1 | |
|  | SM11281 | SM11427 | BIKT R/L 40-K5C t max:10 | 105 € | 1 | MGM. 5C |
| | SM25677 | SM25639 | BIKT R/L 50-K5C t max:15 | 265 € | 1 | |
| | SM55599 | SM55612 | BIKT R/L 32-K6C t max:8   | 73 € | 1 | |
|  | SM55605 | SM55629 | BIKT R/L 40-K6C t max:10   | 105 € | 1 | MGM. 6C |
| | SM25660 | SM25622 | BIKT R/L 50-K6C t max:15 | 265 € | 1 | |
| | SM55636 | SM55643 | BIKT R/L 40-K8C t max:10   | 105 € | 1 | |
|  | SM25653 | SM25615 | BIKT R/L 50-K8C t max:15 | 265 € | 1 | MGM. 8C |



Internal Grooving Tools

| Size Designation | Master Insert* | Spare Parts | |
|------------------|---|---|---|
| | | Screw | Allen Key |
| Ø16 |  MGM.. (1.5C - 2C) |  BKT V M4x15-9210 |  SAK-AA3-9902 |
| Ø20 | | BKT V M5x17-9211 | |
| Ø25 | MGM.. (2C - 5C) | BKT V M6x22-9214 | SAK-AA4-9903 |
| Ø25 (D25) | | BKT V M5x17-9221 | |
| Ø32 | MGM.. (3C - 6C) | BKT V M6x25-9215 | |
| Ø40 - Ø50 | | BKT V M8x1x25-9232 | |

*Suitable Insert brand is KRLY.





| Ordering Code | | Item Designation | Price | Master Insert* |
|------------------|-------------|---------------------------|-------------|---|
| <i>Direction</i> | | <i>BIKT R/L</i> | <i>EURO</i> |  |
| <i>Right</i> | <i>Left</i> | <i>KGM.-KRLY</i> | | |
| SM25585 | SM34754 | BIKT R/L 20-KG-2C t max:6 | 65 € | KGM. 2C |
| SM25608 | SM25578 | BIKT R/L 25-KG-2C t max:7 | 70 € | |
| SM25592 | SM25561 | BIKT R/L 25-KG-3C t max:7 | 70 € | KGM. 3C |
| SM25547 | SM25523 | BIKT R/L 32-KG-3C t max:8 | 74 € | |
| SM38653 | SM25554 | BIKT R/L 25-KG-4C t max:7 | 70 € | KGM. 4C |
| SM25530 | SM25516 | BIKT R/L 32-KG-4C t max:8 | 74 € | |

| Size Designation | Master Insert* | Spare Parts | |
|------------------|---|---|---|
| | | Screw | Allen Key |
| |  |  |  |
| Ø20 | KGM..(2C) | BKTV M5x17-9211 | SAK-AA4-9903 |
| Ø25 | KGM..(2C - 4C) | BKTV M6x22-9214 | |
| Ø32 | KGM..(3C - 4C) | BKTV M6x25-9215 | |







| Ordering Code | | Item Designation | Price | Master Insert* |
|------------------|-------------|-----------------------------|-------------|---|
| <i>Direction</i> | | <i>BIRT R/L (45)</i> | <i>EURO</i> |  |
| <i>Right</i> | <i>Left</i> | <i>MRMN-KRLY</i> | | |
| SM48522 | SM48539 | BIRT R/L 25-KR-3C t max:3.5 | 83 € | MR. 3C |
| SM48560 | SM48577 | BIRT R/L 32-KR-3C t max:3.5 | 87 € | |
| SM48621 | SM48638 | BIRT R/L 40-KR-3C t max:3.5 | 120 € | MR. 4C |
| SM48553 | SM48546 | BIRT R/L 25-KR-4C t max:3.5 | 83 € | |
| SM48591 | SM48584 | BIRT R/L 32-KR-4C t max:3.5 | 87 € | MR. 5C |
| SM48652 | SM48645 | BIRT R/L 40-KR-4C t max:3.5 | 120 € | |
| SM48607 | SM48614 | BIRT R/L 32-KR-5C t max:3.5 | 87 € | MR. 5C |
| SM48669 | SM48676 | BIRT R/L 40-KR-5C t max:3.5 | 120 € | |

| Size Designation | Master Insert* | Spare Parts | |
|------------------|---|---|---|
| | | Screw | Allen Key |
| |  |  |  |
| Ø25 | MR..(3C - 4C) | BKTV M5x17-9211 | SAK-AA4-9903 |
| Ø32 | MR..(3C - 5C) | BKTV M6x22-9214 | |
| Ø40 | MR..(3C - 5C) | | |

*Suitable Insert brand is KRLY.





| Ordering Code | | Item Designation | Price | Master Insert* |
|------------------|-------------|--------------------------------------|-------------|---|
| <i>Direction</i> | | BIKT R/L GRIP / DGN | <i>EURO</i> |  |
| <i>Right</i> | <i>Left</i> | | | |
| SM10871 | SM25745 | BIKT R/L 16-IG3C t max:4 | 64 € | GRIP 3C |
| SM48768 | SM48775 | BIKT R/L 20-IG3C t max:6 | 65 € | |
| SM49031 | SM49024 | BIKT R/L 25-IG3C t max:7 | 70 € | |
| SM10918 | SM25707 | BIKT R/L 25-IG4C t max:7 | 70 € | GRIP 4C |
| SM10970 | SM25691 | BIKT R/L 32-IG4C t max:8 | 74 € | |
| SM10888 | SM25738 | BIKT R/L 20-ID3C t max:6 | 65 € | DGN 3C |
| SM10895 | SM25721 | BIKT R/L 25-ID3C t max:7 | 70 € | |
| SM10901 | SM25714 | BIKT R/L 32-ID3C t max:8 | 74 € | |

| Size Designation | Master Insert* | Spare Parts | |
|------------------|---|---|---|
| | | Screw | Allen Key |
| |  |  |  |
| Ø16 | GRIP - DGN (3C) | BKTV M4x15- 9210 | SAK-AA3- 9902 |
| Ø20 | | BKTV M5x17- 9211 | SAK-AA4- 9903 |
| Ø25 | GRIP (3C - 4C) | BKTV M6x22- 9214 | |
| Ø32 | GRIP - DGN (3C - 4C) | BKTV M6x25- 9215 | |





| Ordering Code | | Item Designation | Price | Master Insert* |
|------------------|-------------|-----------------------|-------------|---|
| <i>Direction</i> | | BIKT R/L GEPI | <i>EURO</i> |  |
| <i>Right</i> | <i>Left</i> | | | |
| SM60500 | SM60562 | BEKT R/L 10-GP2C T2.4 | 68 € | GEPI 2C |
| SM60517 | SM60579 | BEKT R/L 12-GP2C T2.6 | 68 € | |
| SM60524 | SM60586 | BEKT R/L 16-GP2C T2.6 | 83 € | |
| SM60531 | SM60593 | BEKT R/L 12-GP3C T2.6 | 68 € | GEPI 3C |
| SM60548 | SM60609 | BEKT R/L 16-GP3C T2.6 | 83 € | |
| SM60555 | SM60616 | BEKT R/L 16-GP3C T4 | 83 € | |

| Size Designation | Master Insert* | Spare Parts | |
|------------------|---|---|---|
| | | Screw | Torx Key |
| |  |  |  |
| Ø10 - 12 | GEPI2 | SSV M3x8- 9508 | STK-T08- 9908 |
| Ø16 | | SSV M3.5x10- 9511 | STK-T15- 9910 |
| Ø10 - 12 | GEPI3 | SSV M3x8- 9508 | STK-T08- 9908 |
| Ø16 | | SSV M3.5x10- 9511 | STK-T15- 9910 |

*Suitable Insert brand is ISC.

| Ordering Code | Direction | | Item Designation | Price | Master Insert* |
|---------------|-----------|---------------------------------|------------------|---------|----------------|
| | Right | Left | | | |
| | | | | | |
| SM10994 | SM11076 | BIKT R/L 20-HK2C (S224) t max:6 | 65 € | S224 2C | |
| SM11007 | SM11083 | BIKT R/L 25-HK2C (S224) t max:7 | 70 € | | |
| SM11014 | SM11090 | BIKT R/L 20-HK3C (S224) t max:6 | 65 € | S224 3C | |
| SM11021 | SM11106 | BIKT R/L 25-HK3C (S224) t max:7 | 70 € | | |
| SM11038 | SM11113 | BIKT R/L 32-HK3C (S224) t max:8 | 74 € | S224 4C | |
| SM11045 | SM11120 | BIKT R/L 20-HK4C (S224) t max:6 | 65 € | | |
| SM11052 | SM11137 | BIKT R/L 25-HK4C (S224) t max:7 | 70 € | S229 3C | |
| SM11069 | SM11144 | BIKT R/L 32-HK4C (S224) t max:8 | 74 € | | |
| SM10697 | SM10789 | BIKT R/L 25-H3C (S229) t max:7 | 70 € | S229 4C | |
| SM10703 | SM10796 | BIKT R/L 32-H3C (S229) t max:8 | 74 € | | |
| SM10710 | SM10802 | BIKT R/L 40-H3C (S229) t max:10 | 105 € | S229 5C | |
| SM10727 | SM10819 | BIKT R/L 25-H4C (S229) t max:7 | 70 € | | |
| SM10734 | SM10826 | BIKT R/L 32-H4C (S229) t max:8 | 74 € | S229 5C | |
| SM10741 | SM10833 | BIKT R/L 40-H4C (S229) t max:10 | 105 € | | |
| SM10758 | SM10840 | BIKT R/L 25-H5C (S229) t max:7 | 70 € | S229 5C | |
| SM10765 | SM10857 | BIKT R/L 32-H5C (S229) t max:8 | 74 € | | |
| SM10772 | SM10864 | BIKT R/L 40-H5C (S229) t max:10 | 105 € | | |





| Size Designation | Master Insert* | Spare Parts | |
|------------------|-----------------------|---|---|
| | | Screw | Allen Key |
| | |  |  |
| Ø20 | S224 - S229 (2C - 4C) | BKTV M5x17-9211 | SAK-AA4-9903 |
| Ø25 | S224 - S229 (2C - 5C) | BKTV M6x22-9214 | |
| Ø32 | S224 - S229 (3C - 5C) | BKTV M6x25-9215 | |
| Ø40 | S229 (3C - 5C) | BKTV M8x1x25-9232 | |

*Suitable Insert brand is HRN.

| Ordering Code | Direction | | Item Designation | Price | Master Insert* |
|---------------|-----------|-------------------------------|------------------|--------|----------------|
| | Right | Left | | | |
| | | | | | |
| SM55650 | SM55735 | BIKT R/L 20-SDV123-2C t max:6 | 66 € | 123-2C | |
| SM55667 | SM55742 | BIKT R/L 25-SDV123-2C t max:7 | 72 € | | |
| SM55674 | SM55759 | BIKT R/L 20-SDV123-3C t max:6 | 66 € | 123-3C | |
| SM55681 | SM55766 | BIKT R/L 25-SDV123-3C t max:7 | 72 € | | |
| SM55698 | SM55773 | BIKT R/L 32-SDV123-3C t max:8 | 75 € | 123-4C | |
| SM55711 | SM55797 | BIKT R/L 25-SDV123-4C t max:7 | 72 € | | |
| SM55728 | SM55803 | BIKT R/L 32-SDV123-4C t max:8 | 75 € | | |



| Size Designation | Master Insert* | Spare Parts | |
|------------------|----------------|---|---|
| | | Screw | Allen Key |
| | |  |  |
| Ø20 | 123 (2C - 4C) | BKTV M5x17-9211 | SAK-AA4-9903 |
| Ø25 | | BKTV M6x22-9214 | SAK-AA5-9904 |
| Ø32 | 123 (3C - 4C) | BKTV M6x25-9215 | |

*Suitable Insert brand is SDVK.

| | Ordering Code | | Item Designation | Price | Master Insert* | |
|---------|---------------|--------------------------------|--------------------------------|-------|----------------|--------|
| | Direction | | <i>BIKT R/L TDC - TGTC</i> | EURO | | Fig. |
| | Right | Left | | | | |
| | SM45125 | SM45187 | BIKT R/L 20-T2C t max:6 | 65 € | 1 | TDC 2C |
| | SM45132 | SM45194 | BIKT R/L 25-T2C t max:7 | 70 € | 1 | |
| | SM45149 | SM45200 | BIKT R/L 20-T3C t max:6 | 65 € | 1 | TDC 3C |
| | SM45156 | SM45217 | BIKT R/L 25-T3C t max:7 | 70 € | 1 | |
| | SM59696 | SM59733 | BEKT R/L 25-T3C t max:7 D25-IJ | 85 € | 3 | |
| | SM48683 | SM48690 | BIKT R/L 32-T3C t max:8 | 74 € | 1 | TDC 4C |
| | SM59702 | SM59740 | BEKT R/L 32-T3C t max:8 D32-IJ | 105 € | 3 | |
| | SM48744 | SM48751 | BIKT R/L 20-T4C t max:6 | 65 € | 1 | |
| | SM48720 | SM48737 | BIKT R/L 25-T4C t max:7 | 70 € | 1 | TDC 4C |
| | SM59719 | SM59757 | BEKT R/L 25-T4C t max:7 D25-IJ | 85 € | 3 | |
| | SM48713 | SM48706 | BIKT R/L 32-T4C t max:8 | 74 € | 1 | |
| SM59726 | SM59764 | BEKT R/L 32-T4C t max:8 D32-IJ | 105 € | 3 | | |

| Size Designation | Master Insert* | Spare Parts | |
|------------------|----------------|-----------------|--------------|
| | | Screw | Allen Key |
| Ø20 | TDC (2C - 4C) | BKTV M5x17-9211 | SAK-AA4-9903 |
| Ø25 | TDC (2C - 4C) | BKTV M6x22-9214 | |
| Ø25 (D25) | TDC (2C - 4C) | BKTV M5x17-9221 | |
| Ø32 | TDC (3C - 4C) | BKTV M6x25-9215 | |



*Suitable Insert brand is TGTC.



| | Ordering Code | | Item Designation | Price | Master Insert* |
|--|---------------|---------|---------------------------|-------|----------------|
| | Direction | | <i>BIKT R/L KYC GDM</i> | EURO | |
| | Right | Left | | | |
| | SM55810 | SM55896 | BIKT R/L 20-KYC2C t max:6 | 65 € | GDM 2020-2C |
| | SM55827 | SM55902 | BIKT R/L 25-KYC2C t max:7 | 70 € | |
| | SM55834 | SM55919 | BIKT R/L 20-KYC3C t max:6 | 65 € | GDM 3020-3C |
| | SM55841 | SM55926 | BIKT R/L 25-KYC3C t max:7 | 70 € | |
| | SM55858 | SM55933 | BIKT R/L 32-KYC3C t max:8 | 74 € | |
| | SM55865 | SM55940 | BIKT R/L 20-KYC4C t max:6 | 65 € | GDM 4020-4C |
| | SM55872 | SM55957 | BIKT R/L 25-KYC4C t max:7 | 70 € | |
| | SM55889 | SM55964 | BIKT R/L 32-KYC4C t max:8 | 74 € | |

| Size Designation | Master Insert* | Spare Parts | |
|------------------|----------------|-----------------|--------------|
| | | Screw | Allen Key |
| Ø20 | GDM (2C - 4C) | BKTV M5x17-9211 | SAK-AA4-9903 |
| Ø25 | | BKTV M6x22-9214 | SAK-AA5-9904 |
| Ø32 | GDM (3C - 4C) | BKTV M6x25-9215 | |



*Suitable Insert brand is KYCR.



Internal Grooving Tools



|  | Ordering Code | | Item Designation | Price | Master Insert* |
|---|------------------|------------------------------|-----------------------------|-------------|---|
| | <i>Direction</i> | | <i>BIKT R/L</i> | <i>EURO</i> |  |
| | <i>Right</i> | <i>Left</i> | <i>ZT.. - ZCC-CT</i> | | |
| | SM55971 | SM55988 | BIKT R/L 16-ZCC2-2C t max:4 | 63 € | ZTDB 2C |
| | SM11434 | SM24700 | BIKT R/L 20-ZCC2-2C t max:6 | 65 € | ZTDB 2C |
| | SM20764 | SM11502 | BIKT R/L 20-ZCC2-3C t max:6 | 65 € | ZTFD 3C |
| | SM11441 | SM11519 | BIKT R/L 25-ZCC2-3C t max:7 | 70 € | ZTFD 3C |
| | SM11458 | SM11526 | BIKT R/L 32-ZCC2-3C t max:8 | 74 € | ZTFD 3C |
| | SM11465 | SM11533 | BIKT R/L 25-ZCC2-4C t max:7 | 70 € | ZTFD 3C |
| | SM11472 | SM11540 | BIKT R/L 32-ZCC2-4C t max:8 | 74 € | ZTGD 4C |
| SM25509 | SM25493 | BIKT R/L 40-ZCC2-4C t max:10 | 105 € | ZTGD 4C | |
| SM11489 | SM11557 | BIKT R/L 32-ZCC2-5C t max:8 | 74 € | ZTHD 5C | |
| SM11496 | SM11564 | BIKT R/L 40-ZCC2-5C t max:10 | 105 € | ZTHD 5C | |



| Size Designation | Master Insert* | Spare Parts | |
|------------------|----------------|---|---|
| | | Screw | Allen Key |
| | |  |  |
| Ø20 | ZT.. (2C - 3C) | BKTV M5x17-9211 | SAK-AA4-9903 |
| Ø25 | ZT.. (3C - 4C) | BKTV M6x22-9214 | |
| Ø32 | ZT.. (3C - 5C) | BKTV M6x25-9215 | |
| Ø40 | ZT.. (4C - 5C) | BKTV M8x1x25-9232 | |

*Suitable Insert brand is ZCC-CT.

|  | Ordering Code | | Item Designation | Price | Master Insert* |
|---|------------------|------------------------|-------------------------------|-------------|---|
| | <i>Direction</i> | | <i>BIKT</i> | <i>EURO</i> |  |
| | | | <i>NF..08-11-14-16 - KRLY</i> | | |
| | SM24458 | | BIKT NF08 A12 L100 I20 | 72 € | NFTG08 |
| | SM24441 | | BIKT NF11 A16 L120 I25 | 72 € | NFTG11 |
| | SM24465 | | BIKT NF14 A16 L120 I30 | 72 € | NFTG14 |
| SM49048 | | BIKT NF16 A16 L120 I30 | 79 € | NFTG16 | |

| Size Designation | Master Insert* | Spare Parts | |
|------------------|----------------|---|---|
| | | Screw | Torx Key |
| | |  |  |
| NF08 | NFTG08 | SSV M2.5x6-9505 | STK-T08-9908 |
| NF11 | NFTG11 | SSV M3.5x10-9511 | STK-T15-9910 |
| NF14 | NFTG14 | | |
| NF16 | NFTG16 | SSV M4x10-9514 | |

|  | Ordering Code | | Item Designation | Price | Master Insert* |
|---|------------------|------------------------|------------------------|-------------|---|
| | <i>Direction</i> | | <i>BIKT</i> | <i>EURO</i> |  |
| | | | <i>MB09 - SDV</i> | | |
| | SM52109 | | BIKT MB09 A16 L120 I25 | 79 € | MB09 |
| | SM52116 | | BIKT MB09 A16 L120 I30 | 79 € | |
| SM52123 | | BIKT MB09 A16 L120 I40 | 79 € | | |

| Size Designation | Master Insert* | Spare Parts | |
|------------------|----------------|---|---|
| | | Screw | Torx Key |
| | |  |  |
| MB09 | MB09 | SSV M4x10-9514 | STK-T15-9910 |

*Suitable Insert brand is KRLY. / **Suitable Insert brand is SDVK.



| Ordering Code | | Item Designation | Price | Master Insert* |
|---------------|---------|-------------------------------|-------|--------------------------------|
| Direction | | SER / L | EURO | |
| Right | Left | | | |
| SM11618 | SM11625 | SER/L 0808 E11 | 47 € | 11 ER/EL ISO |
| SM11571 | SM11588 | SER/L 1010 E11 | 47 € | |
| SM11632 | SM11649 | SER/L 1212 F11 | 47 € | |
| SM11595 | SM11601 | SER/L 1616 H11 | 47 € | 16 ER/EL ISO (0.35-3) |
| SM11700 | SM11717 | SER/L 1616 H16 | 48 € | |
| SM11656 | SM11663 | SER/L 2020 K16 | 51 € | |
| SM11670 | SM11687 | SER/L 2525 M16 | 57 € | |
| SM57968 | SM57975 | SER/L 2525 M16-JT** | 96 € | 16 ER/EL (Trapezoidal) (1.5-3) |
| SM11724 | SM11694 | SER/L 3232 P16 | 66 € | |
| SM56923 | SM56930 | SETR/L 2525 M16 (Trapezoidal) | 57 € | 22 ER/EL ISO (3.5-4.5) |
| SM57135 | SM57142 | SETR/L 3232 P16 (Trapezoidal) | 66 € | |
| SM50709 | SM50716 | SER/L 2020 K22 | 55 € | 22 ER/EL (Trapezoidal) (4-6) |
| SM11731 | SM11755 | SER/L 2525 M22 | 58 € | |
| SM11762 | SM11748 | SER/L 3232 P22 | 66 € | 11 ER/EL ISO |
| SM11779 | SM11786 | SER/L 4040 S22 | 114 € | |
| SM56947 | SM56954 | SETR/L 2525 M22 (Trapezoidal) | 58 € | 11 ER/EL ISO |
| SM57098 | SM57111 | SETR/L 3232 P22 (Trapezoidal) | 66 € | |
| SM57104 | SM57128 | SETR/L 4040 S22 (Trapezoidal) | 114 € | |
| SM59504 | SM59535 | SER/L 1010 K11 K.O | 47 € | 11 ER/EL ISO |
| SM59511 | SM59542 | SER/L 1212 K11 K.O | 47 € | |
| SM59528 | SM59559 | SER/L 1616 K11 K.O | 47 € | |

Cooling accessories are optional / See Page 297 for cooling accessory.
Soğutma ekipmanları opsiyoneldir / Bkz. Sayfa 297 Soğutma aksesuarları için

Threading Tools





| Size Designation | Master Insert* | Spare Parts | | | |
|---------------------------|---------------------|------------------|------------------|-------------------------|--------------|
| | | Clamp Screw | Shim | Shim Screw | Torx Key |
| 0808 - 1616 | 11 ER/EL | SSV M2.5x6-9505 | - | - | STK-T08-9908 |
| 1616 | 16 ER/EL (0.35-3) | SSV M3.5x10-9511 | BAX ER/L-16-9623 | SBV5 M5.05-A3.5x9-9408 | STK-T15-9910 |
| 2020 - 3232 | | SSV M3.5x14-9512 | - | SBV M5.05 A3.5x11-9407 | |
| 2525 - 3232 (Trapezoidal) | 16 ER/EL-TR (1.5-3) | - | - | - | |
| 2020 - 4040 | 22 ER/EL (3.5-4.5) | SSV M4x14-9516 | BAX ER/L-22-9624 | SBV1 M6x0.75 A4x12-9409 | - |
| 2525 -4040 (Trapezoidal) | 22 ER/EL-TR (4-6) | | - | - | |

*Suitable Insert brand is ISO.

**With coolant hole / İçten su vermeli





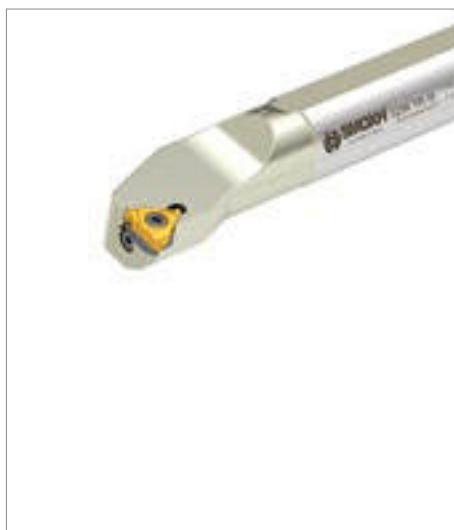

| Ordering Code | | Item Designation | Price | Master Insert* |
|---------------|---------|------------------|-------|---|
| Direction | | TER / L | EURO |  |
| Right | Left | | | |
| SM34815 | SM34808 | TER/L 1616 H16 | 48 € | 16 ER/EL ISO |
| SM29828 | SM29835 | TER/L 2020 K16 | 51 € | |
| SM29842 | SM29859 | TER/L 2525 M16 | 57 € | |
| SM34822 | SM34839 | TER/L 3232 P16 | 66 € | |
| SM34846 | SM34853 | TER/L 2525 M22 | 58 € | 22 ER/EL ISO |
| SM34860 | SM34877 | TER/L 3232 P22 | 66 € | |
| SM34891 | SM34884 | TER/L 4040 S22 | 114 € | 27 ER/EL ISO |
| SM50662 | SM50679 | TER/L 3232 P27 | 88 € | |
| SM50686 | SM50693 | TER/L 4040 S27 | 151 € | |

| Size Designation | Master Insert* | Spare Parts | | | |
|------------------|---|---|---|---|---|
| |  | Clamp Screw | Shim | Shim Screw | Torx Key |
| 1616 - 3232 | 16 ER/EL |  |  |  |  |
| 2525 - 4040 | 22 ER/EL | SSV M3.5x10-9511 | BAX TER-16-9625 BAX TEL-16-9626 | TASV1 M3x9-9220 | |
| 3232 - 4040 | 27 ER/EL | SSV M4x14-9516 | BAX TER-22-9627 BAX TEL-22-9628 | TASV2 M4x12-9221 | STK-T15-9910 |
| | | SSV M5x18-9530 | BAX TER-27-9630 BAX TEL-27-9631 | | STK-T20-9911 |

*Suitable Insert brand is ISO.









| Ordering Code | | Item Designation | Price | Master Insert* |
|---------------|---------|------------------|-------|---|
| Direction | | TIR / L | EURO |  |
| Right | Left | | | |
| SM44685 | SM44692 | S25R TIR/L-16 | 52 € | 16 IR/IL ISO |
| SM44708 | SM44715 | S32S TIR/L-16 | 74 € | |
| SM44722 | SM44739 | S40T TIR/L-16 | 92 € | |
| SM44746 | SM44753 | S25R TIR/L-22 | 53 € | 22 IR/IL ISO |
| SM44760 | SM44777 | S32S TIR/L-22 | 77 € | |
| SM44784 | SM44791 | S40T TIR/L-22 | 98 € | 27 IR/IL ISO |
| SM51010 | SM51027 | S32S TIR/L-27 | 105 € | |
| SM51034 | SM51041 | S40T TIR/L-27 | 132 € | |
| SM00517 | SM00524 | S50U TIR/L-27 | 165 € | |





| Size Designation | Master Insert* | Spare Parts | | | |
|------------------|----------------|---|---|---|---|
| | | Clamp Screw | Shim | Shim Screw | Torx Key |
| S25 - S40 | 16 IR/IL ISO |  |  |  |  |
| S25 - S40 | 22 IR/IL ISO | SSV M3.5x14-9512 | BAX TER-16-9625 TEL-16-9626 | TASV1 M3x9-9220 | |
| S32 - S40 | 27 IR/IL ISO | SSV M4x14-9516 | BAX TER-22-9627 TEL-22-9628 | TASV2 M4x12-9221 | STK-T15-9910 |
| | | SSV M5x18-9530 | BAX TER-27-9630 BAX TEL-27-9631 | | STK-T20-9911 |

*Suitable Insert brand is ISO.



| Ordering Code | | Item Designation | Price | Master Insert* |
|---------------|---------|--|-------|---|
| Direction | | SIR/L | EURO |  |
| Right | Left | | | |
| SM11793 | SM11809 | S16x07M SIR/L-08 | 40 € | 08 IR/IL ISO |
| SM11830 | SM11847 | S10K SIR/L-11 | 40 € | 11 IR/IL ISO |
| SM11854 | SM11861 | S12K SIR/L-11 | 40 € | |
| SM00579 | SM00586 | S16M SIR/L-11 | 47 € | |
| SM11878 | SM11885 | S16x10M SIR/L-11 | 47 € | |
| SM11823 | SM11816 | S16x13M SIR/L-11 | 47 € | |
| SM11991 | SM12004 | S16x13M SIR/L-16 | 47 € | 16 IR/IL ISO (0.35-3) |
| SM11915 | SM11953 | S16M SIR/L-16 | 47 € | |
| SM12011 | SM12028 | S20x16P SIR/L-16 | 47 € | |
| SM11922 | SM11960 | S20P SIR/L-16 | 47 € | |
| SM11939 | SM11977 | S25R SIR/L-16 | 52 € | |
| SM11946 | SM11892 | S32S SIR/L-16 | 70 € | |
| SM11984 | SM11908 | S40T SIR/L-16 | 85 € | |
| SM56961 | SM56978 | S25R SITR/L-16 (Trapezoidal)  | 52 € | |
| SM56985 | SM56992 | S32S SITR/L-16 (Trapezoidal)  | 70 € | |
| SM12042 | SM12080 | S20P SIR/L-22 | 47 € | 22 IR/IL ISO (3.5-4.5) |
| SM12059 | SM12097 | S25R SIR/L-22 | 48 € | |
| SM12066 | SM12103 | S32S SIR/L-22 | 77 € | |
| SM12073 | SM12035 | S40T SIR/L-22 | 94 € | |
| SM57005 | SM57012 | S25R SITR/L-22 (Trapezoidal)  | 77 € | 22 IR/IL Trapezoidal (4-6) |
| SM57029 | SM57036 | S32S SITR/L-22 (Trapezoidal)  | 77 € | |
| SM57159 | SM57166 | S40T SITR/L-22 (Trapezoidal)  | 94 € | |

Threading Tools

| Size Designation | Master Insert* | Spare Parts | | | |
|-------------------------|---|---|---|---|---|
| | | Clamp Screw | Shim | Shim Screw | Torx Key |
| |  |  |  |  |  |
| S16x07 | 08 IR/IL ISO | SSV M2.2x5-9503 | - | - | STK-T06-9906 |
| S10 - S16 | 11 IR/IL | SSV M2.5x6-9505 | - | - | STK-T08-9908 |
| S16x13 | 16 IR/IL-ISO (0.35-3) | SSV M3.5x8-9510 | - | - | STK-T15-9910 |
| S16 - S20 | | SSV M3.5x10-9511 | - | - | |
| S25 | | BAX ER/L-16-9623 | - | SBV5 M5.05-A3.5x9-9408 | |
| S32 - S40 | | | | SBV M5.05-A3.5x11-9407 | |
| S25 - S32 (Trapezoidal) | 16 IR/IL-TR (1.5-3) | SSV M3.5x14-9512 | - | - | |
| S20 - S25 | 22 IR/IL ISO (3.5-4.5) | SSV M4x12-9515 | - | - | |
| S32 - S40 | | BAX ER/L-22-9624 | - | SBV3 M6x0.75 A4x10-9412 | |
| S25 - S40 (Trapezoidal) | 22 IR/IL-TR (4-6) | | | SSV M4x14-9516 | - |

*Suitable Insert brand is ISO.

















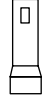
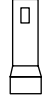
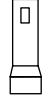
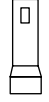
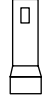









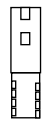





































| Ordering Code | Item Designation | Price | Master Insert |
|------------------------|------------------------------|-------------|---|
| THREADING TOOLS | | <i>EURO</i> |  |
| SM49796 | SDT C14 D12 W20 L100 Z01-H | 105 € | 14 CPT |
| SM49802 | SDT C14 D14.5 W20 L100 Z01-H | 105 € | |
| SM49819 | SDT C14 D17 W20 L100 Z01-H | 109 € | |
| SM49826 | SDT C21 D18 W20 L100 Z01-H | 109 € | 21 CPT |
| SM49833 | SDT C21 D21 W20 L120 Z01-H | 109 € | |
| SM49840 | SDT C21 D29 W25 L120 Z01-H | 114 € | |
| SM49857 | SDT C21 D25 W20 L120 Z01-H | 114 € | |
| SM49864 | SDT C21 D38 W32 L120 Z02-H | 124 € | |

| Size Designation | Master Insert* | Spare Parts | | |
|------------------|---|---|---|--|
| |  | Screw | Torx Key | Screw Torque Value |
| D12.5 - D17 | 14 CPT |  SSV M2.5x6- 9505 |  STK-T08- 9908 |  N·m 1,2 |
| D18 - D38 | 21 CPT |  SSV M4x10- 9514 | STK-T15- 9910 | 3,0 |

*Suitable Insert brand is CPT.

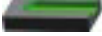

















| Insert | | APKT 1003.. ISO | APKT 1604.. ISO | APMT 0602.. KRLY | APMT 11T3.. KRLY | APMT 1135.. YG-1 | APKT 09T3.. TGTC |
|--------------------|-----------------------|---|--|---|---|---|---|
| | |  |  |  |  |  |  |
| Page | | F144-145 | F146-147 | F148 | F148 | F149 | F150 |
| Dimeter Range (mm) | | Ø12-125 | Ø25-200 | Ø10-123 | Ø16-80 | Ø16-80 | Ø16-20 |
| Approach Angle | | 90° | 90° | 90° | 90° | 90° | 90° |
| Max. Cutting Depth | | 10mm | 16mm | 6mm | 11mm | 11mm | 8.8mm |
| Holder Type | Endmills |  Dia Range (mm) Ø12-40 |  Dia Range (mm) Ø25-40 |  Dia Range (mm) Ø10-13 |  Dia Range (mm) Ø16-32 |  Dia Range (mm) Ø16-26 |  Dia Range (mm) Ø16-20 |
| | Modular Mills |  Dia Range (mm) Ø16-42 |  Dia Range (mm) Ø25-42 | - |  Dia Range (mm) Ø16-25 |  Dia Range (mm) Ø16-25 |  Dia Range (mm) Ø16-20 |
| | Face Mills |  Dia Range (mm) Ø40-125 |  Dia Range (mm) Ø40-200 | - |  Dia Range (mm) Ø40-80 |  Dia Range (mm) Ø40-80 | - |
| | Helical Mills |  Dia Range (mm) Ø20-40 | - | - | - | - | - |
| Application | Face Milling |  ✓ |  ✓ |  ✓ |  ✓ |  ✓ |  ✓ |
| | Shoulder Milling |  ✓ |  ✓ |  ✓ |  ✓ |  ✓ |  ✓ |
| | Slot Milling |  ✓ |  ✓ |  ✓ |  ✓ |  ✓ |  ✓ |
| | Plunging |  ✓ |  ✓ |  ✓ |  ✓ |  ✓ |  ✓ |
| | Helical Interpolation |  ✓ |  ✓ |  ✓ |  ✓ |  ✓ |  ✓ |
| | Side Profile Milling |  ✓ | - | - | - | - | - |
| | Profile Milling |  - | - | - | - | - | - |
| | | | | | | | |
| | | | | | | | |

| Insert | | APKT 1204.. TGTC | APKT 1705.. TGTC | APKT 11T3.. ZCC | R390.0702.. SDV | R390.11T3.. SDV | R390.1704.. SDV | R390.1806.. SDV |
|--------------------|---|---|---|---|--|---|---|---|
| | |  |  |  |  |  |  |  |
| Page | | F150 | F150 | F151 | F152 | F152 | F152 | F152 |
| Dimeter Range (mm) | | Ø20-63 | Ø25-100 | Ø16-63 | Ø10-16 | Ø16-63 | Ø25-125 | Ø50-160 |
| Approach Angle | | 90° | 90° | 90° | 90° | 90° | 90° | 90° |
| Max. Cutting Depth | | 12mm | 16mm | 11mm | 5.8mm | 10mm | 15.7mm | 15.4mm |
| Holder Type | Endmills  | ✓ Dia Range (mm) Ø20-32 | ✓ Dia Range (mm) Ø25-32 | ✓ Dia Range (mm) Ø16-32 | ✓ Dia Range (mm) Ø10-16 | ✓ Dia Range (mm) Ø16-25 | ✓ Dia Range (mm) Ø25-30 | - |
| | Modular Mills  | ✓ Dia Range (mm) Ø20-32 | - | ✓ Dia Range (mm) Ø16-25 | - | ✓ Dia Range (mm) Ø16-32 | - | - |
| | Face Mills  | ✓ Dia Range (mm) Ø40-63 | ✓ Dia Range (mm) Ø50-100 | ✓ Dia Range (mm) Ø40-63 | - | ✓ Dia Range (mm) Ø40-63 | ✓ Dia Range (mm) Ø50-125 | ✓ Dia Range (mm) Ø50-160 |
| | Helical Mills  | - | - | - | - | - | - | - |
| Application | Face Milling  | ✓ | ✓ | ✓ | ✓ | ✓ | ✓ | ✓ |
| | Shoulder Milling  | ✓ | ✓ | ✓ | ✓ | ✓ | ✓ | ✓ |
| | Slot Milling  | ✓ | ✓ | ✓ | ✓ | ✓ | ✓ | ✓ |
| | Plunging  | ✓ | ✓ | ✓ | ✓ | ✓ | ✓ | ✓ |
| | Helical Interpolation  | ✓ | ✓ | ✓ | ✓ | ✓ | ✓ | ✓ |
| | Side Profile Milling  | - | - | - | - | - | - | - |
| | Profile Milling  | - | - | - | - | - | - | - |
| | | | | | | | | |
| | | | | | | | | |

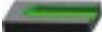
| Insert | | AS.T 11T3.. TNGLY | BD.T 0703.. KYCR | BD.T 11T3.. KYCR | BD.T 1704.. KYCR | AXMT 1235.. SMTM | AXMT 1705.. SMTM |
|--------------------|-----------------------|--|---|---|---|--|---|
| | |  |  |  |  |  |  |
| Page | | F153 | F154 | F154-155 | F154-155 | F156-157 | F156-157 |
| Dimeter Range (mm) | | Ø16-63 | Ø10-12 | Ø16-100 | Ø25-100 | Ø16-80 | Ø25-100 |
| Approach Angle | | 90° | 90° | 90° | 90° | 90° | 90° |
| Max. Cutting Depth | | 10.6mm | 6mm | 10mm | 15.7mm | 10mm | 14mm |
| Holder Type | Endmills |  Dia Range (mm) Ø16-32 |  Dia Range (mm) Ø10-12 |  Dia Range (mm) Ø16-32 |  Dia Range (mm) Ø25-32 |  Dia Range (mm) Ø16-25 |  Dia Range (mm) Ø25-40 |
| | Modular Mills |  Dia Range (mm) Ø20-32 | - |  Dia Range (mm) Ø16-32 | - |  Dia Range (mm) Ø16-25 |  Dia Range (mm) Ø32-40 |
| | Face Mills |  Dia Range (mm) Ø40-63 | - |  Dia Range (mm) Ø40-100 |  Dia Range (mm) Ø40-100 |  Dia Range (mm) Ø40-80 |  Dia Range (mm) Ø40-100 |
| | Helical Mills |  - | - | - | - | - | - |
| Application | Face Milling |  ✓ | ✓ | ✓ | ✓ | ✓ | ✓ |
| | Shoulder Milling |  ✓ | ✓ | ✓ | ✓ | ✓ | ✓ |
| | Slot Milling |  ✓ | ✓ | ✓ | ✓ | ✓ | ✓ |
| | Plunging |  ✓ | ✓ | ✓ | ✓ | ✓ | ✓ |
| | Helical Interpolation |  ✓ | ✓ | ✓ | ✓ | ✓ | ✓ |
| | Side Profile Milling |  - | - | - | - | - | - |
| | Profile Milling |  - | - | - | - | - | - |















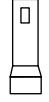

| Insert | | ADMX 0702.. PRMT | ADMX 11T3.. PRMT | ADMX 1606.. PRMT | ADKT 1505.. | ADMT 0803.. WLTR | ADMT 10T3.. WLTR |
|--------------------|---|---|---|---|--|---|---|
| | |  |  |  |  |  |  |
| Page | | F158 | F158 | F158 | F159 | F160 | F160 |
| Dimeter Range (mm) | | Ø10-12 | Ø20-63 | Ø25-80 | Ø25-125 | Ø16-25 | Ø16-63 |
| Approach Angle | | 90° | 90° | 90° | 90° | 90° | 90° |
| Max. Cutting Depth | | 7mm | 10.5mm | 10.5mm | 14.3mm | 8mm | 10mm |
| Holder Type | Endmills  | ✓ Dia Range (mm) Ø10-12 | ✓ Dia Range (mm) Ø20-32 | ✓ Dia Range (mm) Ø25-32 | ✓ Dia Range (mm) Ø25-32 | ✓ Dia Range (mm) Ø16-25 | ✓ Dia Range (mm) Ø16-25 |
| | Modular Mills  | - | - | - | ✓ Dia Range (mm) Ø25-32 | ✓ Dia Range (mm) Ø16-25 | ✓ Dia Range (mm) Ø16-25 |
| | Face Mills  | - | ✓ Dia Range (mm) Ø40-63 | ✓ Dia Range (mm) Ø50-80 | ✓ Dia Range (mm) Ø40-125 | - | ✓ Dia Range (mm) Ø40-63 |
| | Helical Mills  | - | - | - | - | - | - |
| Application | Face Milling  | ✓ | ✓ | ✓ | ✓ | ✓ | ✓ |
| | Shoulder Milling  | ✓ | ✓ | ✓ | ✓ | ✓ | ✓ |
| | Slot Milling  | ✓ | ✓ | ✓ | ✓ | ✓ | ✓ |
| | Plunging  | ✓ | ✓ | ✓ | ✓ | ✓ | ✓ |
| | Helical Interpolation  | ✓ | ✓ | ✓ | ✓ | ✓ | ✓ |
| | Side Profile Milling  | - | - | - | - | - | - |
| | Profile Milling  | - | - | - | - | - | - |
| | | | | | | | |
| | | | | | | | |

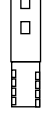

| Insert | | | ADKT 1204.. WLTR | ADMT 1606.. WLTR | RT 0703.. SAFETY | RT 1003.. SAFETY | RT 1606.. SAFETY | XOMX 0602.. SCO |
|--------------------|-----------------------|---|---|---|---|--|---|---|
| | | |  |  |  |  |  |  |
| Page | | | F160 | F160 | F162 | F162-163 | F162-163 | F164 |
| Dimeter Range (mm) | | | Ø20-80 | Ø50-80 | Ø10-14 | Ø16-63 | Ø25-100 | Ø10-20 |
| Approach Angle | | | 90° | 90° | 90° | 90° | 90° | 90° |
| Max. Cutting Depth | | | 11.7mm | 15mm | 7mm | 10mm | 16mm | 5.5mm |
| Holder Type | Endmills |  | ✓ Dia Range (mm) Ø20-32 | - | ✓ Dia Range (mm) Ø10-14 | ✓ Dia Range (mm) Ø16-25 | ✓ Dia Range (mm) Ø25-40 | ✓ Dia Range (mm) Ø10-20 |
| | Modular Mills |  | ✓ Dia Range (mm) Ø20-32 | - | - | ✓ Dia Range (mm) Ø25-42 | - | - |
| | Face Mills |  | ✓ Dia Range (mm) Ø40-80 | ✓ Dia Range (mm) Ø50-80 | - | ✓ Dia Range (mm) Ø40-63 | ✓ Dia Range (mm) Ø50-100 | - |
| | Helical Mills |  | - | - | - | - | - | - |
| Application | Face Milling |  | ✓ | ✓ | ✓ | ✓ | ✓ | ✓ |
| | Shoulder Milling |  | ✓ | ✓ | ✓ | ✓ | ✓ | ✓ |
| | Slot Milling |  | ✓ | ✓ | ✓ | ✓ | ✓ | ✓ |
| | Plunging |  | ✓ | ✓ | ✓ | ✓ | ✓ | ✓ |
| | Helical Interpolation |  | ✓ | ✓ | ✓ | ✓ | ✓ | ✓ |
| | Side Profile Milling |  | - | - | - | - | - | - |
| | Profile Milling |  | - | - | - | - | - | - |
| | | | | | | | | |
| | | | | | | | | |











| Insert | | XOMX 10T3.. SCO | XOMX 1204.. SCO | XOMX 1806.. SCO | EDPT 10T3.. KNMTL | EDPT 1404.. KNMTL | AOMT 1236.. MTSBH |
|--------------------|---|---|---|---|--|---|---|
| | |  |  |  |  |  |  |
| Page | | F164-165 | F164-165 | F165 | F161 | F161 | F166 |
| Dimeter Range (mm) | | Ø16-63 | Ø20-125 | Ø50-125 | Ø16-63 | Ø20-80 | Ø16-100 |
| Approach Angle | | 90° | 90° | 90° | 90° | 90° | 90° |
| Max. Cutting Depth | | 9mm | 11mm | 17mm | 9.80mm | 14mm | 10mm |
| Holder Type | Endmills  | ✓ Dia Range (mm) Ø16-20 | ✓ Dia Range (mm) Ø20-32 | - | ✓ Dia Range (mm) Ø16-32 | ✓ Dia Range (mm) Ø20-40 | ✓ Dia Range (mm) Ø16-32 |
| | Modular Mills  | ✓ Dia Range (mm) Ø16-20 | ✓ Dia Range (mm) Ø20-32 | - | ✓ Dia Range (mm) Ø16-32 | ✓ Dia Range (mm) Ø20-32 | ✓ Dia Range (mm) Ø16-32 |
| | Face Mills  | ✓ Dia Range (mm) Ø40-63 | ✓ Dia Range (mm) Ø40-125 | ✓ Dia Range (mm) Ø50-125 | ✓ Dia Range (mm) Ø40-63 | ✓ Dia Range (mm) Ø40-80 | ✓ Dia Range (mm) Ø40-100 |
| | Helical Mills  | - | - | - | - | - | - |
| Application | Face Milling  | ✓ | ✓ | ✓ | ✓ | ✓ | ✓ |
| | Shoulder Milling  | ✓ | ✓ | ✓ | ✓ | ✓ | ✓ |
| | Slot Milling  | ✓ | ✓ | ✓ | ✓ | ✓ | ✓ |
| | Plunging  | ✓ | ✓ | ✓ | ✓ | ✓ | ✓ |
| | Helical Interpolation  | ✓ | ✓ | ✓ | ✓ | ✓ | ✓ |
| | Side Profile Milling  | - | - | - | - | - | - |
| | Profile Milling  | - | - | - | - | - | - |











| Insert | | | XDKT 0703.. CRTZ | XDKT 11T3.. CRTZ | AXMT 0602.. TGTC | APKT 0602.. LMN | AOMT 0702.. TNGLY | |
|--------------------|-----------------------|---|---|---|---|--|---|--|
| | | |  |  |  |  |  | |
| Page | | | F167 | F167 | F167 | F167 | F166 | |
| Dimeter Range (mm) | | | Ø12-17 | Ø16-26 | Ø10-16 | Ø10-13 | Ø12-22 | |
| Approach Angle | | | 90° | 90° | 90° | 90° | 90° | |
| Max. Cutting Depth | | | 7mm | 11mm | 5.75mm | 5.5mm | 7mm | |
| Holder Type | Endmills |  | ✓ Dia Range (mm) Ø12-17 | ✓ Dia Range (mm) Ø16-26 | ✓ Dia Range (mm) Ø10-16 | ✓ Dia Range (mm) Ø10-13 | ✓ Dia Range (mm) Ø12-22 | |
| | Modular Mills |  | - | - | - | - | - | |
| | Face Mills |  | - | - | - | - | - | |
| | Helical Mills |  | - | - | - | - | - | |
| Application | Face Milling |  | ✓ | ✓ | ✓ | ✓ | ✓ | |
| | Shoulder Milling |  | ✓ | ✓ | ✓ | ✓ | ✓ | |
| | Slot Milling |  | ✓ | ✓ | ✓ | ✓ | ✓ | |
| | Plunging |  | ✓ | ✓ | ✓ | ✓ | ✓ | |
| | Helical Interpolation |  | ✓ | ✓ | ✓ | ✓ | ✓ | |
| | Side Profile Milling |  | - | - | - | - | - | |
| | Profile Milling |  | - | - | - | - | - | |
| | | | | | | | | |
| | | | | | | | | |





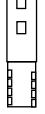











| Insert | | | LNHU 0904.. WLTR | LNMU 1306.. WLTR | LNMT 0804.. | LNMT 1306.. | LOEX 0804.. SCO | LP.U 0904.. SCO |
|--------------------|-----------------------|---|---|---|---|---|---|---|
| | | |  |  |  |  |  |  |
| Page | | | F168 | F168 | F169 | F169 | F170 | F171 |
| Dimeter Range (mm) | | | Ø20-80 | Ø40-100 | Ø16-80 | Ø32-125 | Ø20-63 | Ø20-63 |
| Approach Angle | | | 90° | 90° | 90° | 90° | 90° | 90° |
| Max. Cutting Depth | | | 8mm | 12mm | 8mm | 12.5mm | 8mm | 8.3mm |
| Holder Type | Endmills |  | ✓ Dia Range (mm) Ø20-32 | - | ✓ Dia Range (mm) Ø16-32 | ✓ Dia Range (mm) Ø32-40 | ✓ Dia Range (mm) Ø20-32 | ✓ Dia Range (mm) Ø20-32 |
| | Modular Mills |  | ✓ Dia Range (mm) Ø20-32 | - | ✓ Dia Range (mm) Ø20-32 | - | ✓ Dia Range (mm) Ø20-32 | ✓ Dia Range (mm) Ø20-32 |
| | Face Mills |  | ✓ Dia Range (mm) Ø40-80 | ✓ Dia Range (mm) Ø40-100 | ✓ Dia Range (mm) Ø40-80 | ✓ Dia Range (mm) Ø50-125 | ✓ Dia Range (mm) Ø40-63 | ✓ Dia Range (mm) Ø40-63 |
| | Helical Mills |  | - | - | - | - | - | - |
| Application | Face Milling |  | ✓ | ✓ | ✓ | ✓ | ✓ | ✓ |
| | Shoulder Milling |  | ✓ | ✓ | ✓ | ✓ | ✓ | ✓ |
| | Slot Milling |  | ✓ | ✓ | ✓ | ✓ | ✓ | ✓ |
| | Plunging |  | ✓ | ✓ | ✓ | ✓ | ✓ | ✓ |
| | Helical Interpolation |  | ✓ | ✓ | ✓ | ✓ | ✓ | ✓ |
| | Side Profile Milling |  | - | - | - | - | - | - |
| | Profile Milling |  | - | - | - | - | - | - |





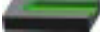









| Insert | | LOGU 0904.. MTSBH | LN.. 1106.. T490 | LNKT 1506.. ZCC | LNKT 1707.. KRLY | AN.X 0904.. | AN.X 1205.. |
|--------------------|---|---|---|---|---|---|---|
| | |  |  |  |  |  |  |
| Page | | F172 | F173 | F173 | F174 | F174 | F174 |
| Dimeter Range (mm) | | Ø16-80 | Ø25-80 | Ø50-125 | Ø50-100 | Ø16-63 | Ø50-100 |
| Approach Angle | | 90° | 90° | 90° | 90° | 90° | 90° |
| Max. Cutting Depth | | 8mm | 9mm | 12mm | 16.5mm | 8mm | 12mm |
| Holder Type | Endmills  | ✓ Dia Range (mm) Ø16-32 | ✓ Dia Range (mm) Ø25-32 | - | - | ✓ Dia Range (mm) Ø16-32 | - |
| | Modular Mills  | ✓ Dia Range (mm) Ø20-32 | - | - | - | ✓ Dia Range (mm) Ø20-25 | - |
| | Face Mills  | ✓ Dia Range (mm) Ø40-80 | ✓ Dia Range (mm) Ø40-80 | ✓ Dia Range (mm) Ø50-125 | ✓ Dia Range (mm) Ø50-100 | ✓ Dia Range (mm) Ø40-63 | ✓ Dia Range (mm) Ø50-100 |
| | Helical Mills  | - | - | - | - | - | - |
| Application | Face Milling  | ✓ | ✓ | ✓ | ✓ | ✓ | ✓ |
| | Shoulder Milling  | ✓ | ✓ | ✓ | ✓ | ✓ | ✓ |
| | Slot Milling  | ✓ | ✓ | ✓ | ✓ | ✓ | ✓ |
| | Plunging  | ✓ | ✓ | ✓ | ✓ | ✓ | ✓ |
| | Helical Interpolation  | ✓ | ✓ | ✓ | ✓ | ✓ | ✓ |
| | Side Profile Milling  | - | - | - | - | - | - |
| | Profile Milling  | - | - | - | - | - | - |
| | | | | | | | |
| | | | | | | | |



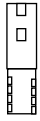



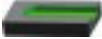
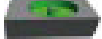









| Insert | | AN.X 1706.. | LN.X 1006.. KRLY | LN.X 1510.. KRLY | LOMU 1004.. KYCR | LOMU 1505.. KYCR | ANGX 1105.. ZCC |
|--------------------|---|---|---|---|--|---|---|
| | |  |  |  |  |  |  |
| Page | | F174 | F175 | F175 | F176 | F176 | F177 |
| Dimeter Range (mm) | | Ø50-125 | Ø16-63 | Ø32-160 | Ø16-63 | Ø40-100 | Ø25-63 |
| Approach Angle | | 90° | 90° | 90° | 90° | 90° | 90° |
| Max. Cutting Depth | | 16.3mm | 9mm | 14mm | 10mm | 15mm | 10mm |
| Holder Type | Endmills  | - | ✓ Dia Range (mm) Ø16-40 | ✓ Dia Range (mm) Ø32-40 | ✓ Dia Range (mm) Ø16-33 | - | ✓ Dia Range (mm) Ø25-32 |
| | Modular Mills  | - | ✓ Dia Range (mm) Ø16-25 | - | ✓ Dia Range (mm) Ø16-32 | - | - |
| | Face Mills  | ✓ Dia Range (mm) Ø50-125 | ✓ Dia Range (mm) Ø40-63 | ✓ Dia Range (mm) Ø50-160 | ✓ Dia Range (mm) Ø40-63 | ✓ Dia Range (mm) Ø40-100 | ✓ Dia Range (mm) Ø40-63 |
| | Helical Mills  | - | - | - | - | - | - |
| Application | Face Milling  | ✓ | ✓ | ✓ | ✓ | ✓ | ✓ |
| | Shoulder Milling  | ✓ | ✓ | ✓ | ✓ | ✓ | ✓ |
| | Slot Milling  | ✓ | ✓ | ✓ | ✓ | ✓ | ✓ |
| | Plunging  | ✓ | ✓ | ✓ | ✓ | ✓ | ✓ |
| | Helical Interpolation  | ✓ | ✓ | ✓ | ✓ | ✓ | ✓ |
| | Side Profile Milling  | - | - | - | - | - | - |
| | Profile Milling  | - | - | - | - | - | - |
| | | | | | | | |
| | | | | | | | |







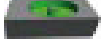









| Insert | | | ANGX 1506.. ZCC | LQMU 1107.. TNGLY | LNGX 1205.. PRMT | LNGU 15T.. KNMTL | XNPU 15T6.. WDA | AN.X 1607.. TGTC | LNGX 1307.. WLTR |
|--------------------|-----------------------|---|---|---|---|---|---|---|---|
| | | |  |  |  |  |  |  |  |
| Page | | | F177 | F177 | F178 | F179 | F179 | F178 | F179 |
| Dimeter Range (mm) | | | Ø50-100 | Ø25-63 | Ø25-100 | Ø40-100 | Ø40-100 | Ø50-100 | Ø50-125 |
| Approach Angle | | | 90° | 90° | 90° | 90° | 90° | 90° | 90° |
| Max. Cutting Depth | | | 14mm | 9mm | 12mm | 15.5mm | 14.5mm | 15mm | 12mm |
| Holder Type | Endmills |  | - | ✓ Dia Range (mm) Ø25-32 | ✓ Dia Range (mm) Ø25-32 | - | - | - | - |
| | Modular Mills |  | - | - | - | - | - | - | - |
| | Face Mills |  | ✓ Dia Range (mm) Ø50-100 | ✓ Dia Range (mm) Ø40-63 | ✓ Dia Range (mm) Ø50-100 | ✓ Dia Range (mm) Ø40-100 | ✓ Dia Range (mm) Ø40-100 | ✓ Dia Range (mm) Ø40-100 | ✓ Dia Range (mm) Ø50-125 |
| | Helical Mills |  | - | - | - | - | - | - | - |
| Application | Face Milling |  | ✓ | ✓ | ✓ | ✓ | ✓ | ✓ | ✓ |
| | Shoulder Milling |  | ✓ | ✓ | ✓ | ✓ | ✓ | ✓ | ✓ |
| | Slot Milling |  | ✓ | ✓ | ✓ | ✓ | ✓ | ✓ | ✓ |
| | Plunging |  | ✓ | ✓ | ✓ | ✓ | ✓ | ✓ | ✓ |
| | Helical Interpolation |  | ✓ | ✓ | ✓ | ✓ | ✓ | ✓ | ✓ |
| | Side Profile Milling |  | - | - | - | - | - | - | - |
| | Profile Milling |  | - | - | - | - | - | - | - |
| | | | | | | | | | |
| | | | | | | | | | |

















| Insert | | 4NKT 0603.. TGTC | XNKT 0604.. KRLY | XNKT 0805.. KRLY | 3PKT 0603.. TGTC | 3PKT 1004.. TGTC | 3PKT 1505.. TGTC |
|--------------------|-----------------------|---|---|--|---|---|--|
| | |  |  |  |  |  |  |
| Page | | F180 | F181 | F181 | F182 | F182 | F182 |
| Dimeter Range (mm) | | Ø16-63 | Ø20-42 | Ø30-125 | Ø12-20 | Ø16-63 | Ø40-125 |
| Approach Angle | | 90° | 90° | 90° | 90° | 90° | 90° |
| Max. Cutting Depth | | 6mm | 5.5mm | 8mm | 5mm | 7mm | 11mm |
| Holder Type | Endmills |  Dia Range (mm) Ø16-32 |  Dia Range (mm) Ø20-33 |  Dia Range (mm) Ø30-40 |  Dia Range (mm) Ø12-20 |  Dia Range (mm) Ø16-32 | - |
| | Modular Mills |  Dia Range (mm) Ø16-42 |  Dia Range (mm) Ø20-42 |  Dia Range (mm) Ø30-40 | - |  Dia Range (mm) Ø20-40 | - |
| | Face Mills |  Dia Range (mm) Ø40-63 | - |  Dia Range (mm) Ø40-125 | - |  Dia Range (mm) Ø40-63 |  Dia Range (mm) Ø40-125 |
| | Helical Mills |  - | - | - | - | - | - |
| Application | Face Milling |  ✓ | ✓ | ✓ | ✓ | ✓ | ✓ |
| | Shoulder Milling |  ✓ | ✓ | ✓ | ✓ | ✓ | ✓ |
| | Slot Milling |  ✓ | ✓ | ✓ | ✓ | ✓ | ✓ |
| | Plunging |  ✓ | ✓ | ✓ | ✓ | ✓ | ✓ |
| | Helical Interpolation |  ✓ | ✓ | ✓ | ✓ | ✓ | ✓ |
| | Side Profile Milling |  - | - | - | - | - | - |
| | Profile Milling |  - | - | - | - | - | - |















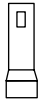

| Insert | | | TN.X 1005.. | TP.T 1003.. | 6NGU 0604.. TGTC | 6NGU 0905.. TGTC | 6NKU 0403.. TGTC | TNGX 1004.. PRMT |
|--------------------|-----------------------|---|---|---|---|--|---|---|
| | | |  |  |  |  |  |  |
| Page | | | F183 | F184 | F184 | F185 | F185 | F183 |
| Dimeter Range (mm) | | | Ø20-63 | Ø25-80 | Ø25-32 | Ø50-80 | Ø20-32 | Ø20-63 |
| Approach Angle | | | 90° | 90° | 90° | 90° | 90° | 90° |
| Max. Cutting Depth | | | 8mm | 8mm | 6.2mm | 9.2mm | 4.1mm | 5mm |
| Holder Type | Endmills |  | ✓ Dia Range (mm) Ø20-32 | ✓ Dia Range (mm) Ø25-32 | ✓ Dia Range (mm) Ø25-32 | - | ✓ Dia Range (mm) Ø20-32 | ✓ Dia Range (mm) Ø20-32 |
| | Modular Mills |  | ✓ Dia Range (mm) Ø20-32 | ✓ Dia Range (mm) Ø25-32 | ✓ Dia Range (mm) Ø25-32 | - | ✓ Dia Range (mm) Ø20-32 | - |
| | Face Mills |  | ✓ Dia Range (mm) Ø40-63 | ✓ Dia Range (mm) Ø40-80 | - | ✓ Dia Range (mm) Ø50-80 | - | ✓ Dia Range (mm) Ø40-63 |
| | Helical Mills |  | - | - | - | - | - | - |
| Application | Face Milling |  | ✓ | ✓ | ✓ | ✓ | ✓ | ✓ |
| | Shoulder Milling |  | ✓ | ✓ | ✓ | ✓ | ✓ | ✓ |
| | Slot Milling |  | ✓ | ✓ | ✓ | ✓ | ✓ | ✓ |
| | Plunging |  | ✓ | ✓ | ✓ | ✓ | ✓ | ✓ |
| | Helical Interpolation |  | ✓ | ✓ | ✓ | ✓ | ✓ | ✓ |
| | Side Profile Milling |  | - | - | - | - | - | - |
| | Profile Milling |  | - | - | - | - | - | - |
| | | | | | | | | |
| | | | | | | | | |

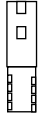















| Insert | | TOMT 0603.. TNGLY | TOMT 1004.. TNGLY | TOMT 1506.. TNGLY | TNMX 1806.. TGTC | WNMU 0806.. KYCR | XNEX 0403.. SCO |
|--------------------|---|---|---|---|--|---|---|
| | |  |  |  |  |  |  |
| Page | | F187 | F187 | F187 | F186 | F187 | F188 |
| Dimeter Range (mm) | | Ø16-25 | Ø25-63 | Ø50-125 | Ø63-100 | Ø50-125 | Ø17-33 |
| Approach Angle | | 90° | 90° | 90° | 90° | 90° | 90° |
| Max. Cutting Depth | | 6mm | 10mm | 15mm | 13mm | 8mm | 4mm |
| Holder Type | Endmills  | ✓ Dia Range (mm) Ø16-25 | ✓ Dia Range (mm) Ø25-32 | - | - | - | ✓ Dia Range (mm) Ø17-33 |
| | Modular Mills  | - | - | - | - | - | ✓ Dia Range (mm) Ø20-25 |
| | Face Mills  | - | ✓ Dia Range (mm) Ø40-63 | ✓ Dia Range (mm) Ø50-125 | ✓ Dia Range (mm) Ø63-100 | ✓ Dia Range (mm) Ø50-125 | ✓ Dia Range (mm) Ø40-125 |
| | Helical Mills  | - | - | - | - | - | - |
| Application | Face Milling  | ✓ | ✓ | ✓ | ✓ | ✓ | ✓ |
| | Shoulder Milling  | ✓ | ✓ | ✓ | ✓ | ✓ | ✓ |
| | Slot Milling  | ✓ | ✓ | ✓ | ✓ | ✓ | ✓ |
| | Plunging  | ✓ | ✓ | ✓ | ✓ | ✓ | ✓ |
| | Helical Interpolation  | ✓ | ✓ | ✓ | ✓ | ✓ | ✓ |
| | Side Profile Milling  | - | - | - | - | - | - |
| | Profile Milling  | - | - | - | - | - | - |
| | | | | | | | |
| | | | | | | | |

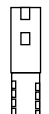















| Insert | | | XNEX 0806.. SCO | WNGX 0806.. KRLY | WNHU 0806.. ZCC | WN.U 0705.. | TPKN 1603.. ISO | TPKN 2204.. ISO |
|--------------------|-----------------------|---|---|---|---|--|---|---|
| | | |  |  |  |  |  |  |
| Page | | | F188 | F189 | F189 | F189 | F190 | F190 |
| Dimeter Range (mm) | | | Ø50-125 | Ø50-100 | Ø50-100 | Ø50-100 | Ø50-125 | Ø63-160 |
| Approach Angle | | | 90° | 90° | 90° | 90° | 90° | 90° |
| Max. Cutting Depth | | | 7.5mm | 8.2mm | 7.5mm | 7mm | 12mm | 18mm |
| Holder Type | Endmills |  | - | - | - | - | - | - |
| | Modular Mills |  | - | - | - | - | - | - |
| | Face Mills |  | Dia Range (mm) Ø50-125 ✓ | Dia Range (mm) Ø50-100 ✓ | Dia Range (mm) Ø50-100 ✓ | Dia Range (mm) Ø50-100 ✓ | Dia Range (mm) Ø50-125 ✓ | Dia Range (mm) Ø63-160 ✓ |
| | Helical Mills |  | - | - | - | - | - | - |
| Application | Face Milling |  | ✓ | ✓ | ✓ | ✓ | ✓ | ✓ |
| | Shoulder Milling |  | ✓ | ✓ | ✓ | ✓ | ✓ | ✓ |
| | Slot Milling |  | ✓ | ✓ | ✓ | ✓ | ✓ | ✓ |
| | Plunging |  | ✓ | ✓ | ✓ | ✓ | ✓ | ✓ |
| | Helical Interpolation |  | ✓ | ✓ | ✓ | ✓ | ✓ | ✓ |
| | Side Profile Milling |  | - | - | - | - | - | - |
| | Profile Milling |  | - | - | - | - | - | - |
| | | | | | | | | |
| | | | | | | | | |

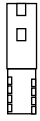















| Insert | | | APKT 1003.. ISO | APKT 1643.. ISO | SEMT 1304.. TGTC | SEET 12T3.. ZCC | SOMT 12T3.. MTSBH | SDMT 09T3.. WLTR |
|--------------------|-----------------------|---|---|---|---|--|---|---|
| | | |  |  |  |  |  |  |
| Page | | | F190 | F190 | F191 | F191 | F192 | F192 |
| Dimeter Range (mm) | | | Ø63-100 | Ø63-125 | Ø50-80 | Ø50-125 | Ø63-100 | Ø25-63 |
| Approach Angle | | | 75° | 75° | 90° | 90° | 90° | 90° |
| Max. Cutting Depth | | | 5mm | 10mm | 11mm | 12mm | 11mm | 8.4mm |
| Holder Type | Endmills |  | - | - | - | - | - | ✓ Dia Range (mm) Ø25-33 |
| | Modular Mills |  | - | - | - | - | - | ✓ Dia Range (mm) Ø20-25 |
| | Face Mills |  | ✓ Dia Range (mm) Ø63-100 | ✓ Dia Range (mm) Ø63-125 | ✓ Dia Range (mm) Ø50-80 | ✓ Dia Range (mm) Ø50-125 | ✓ Dia Range (mm) Ø63-100 | ✓ Dia Range (mm) Ø40-63 |
| | Helical Mills |  | - | - | - | - | - | - |
| Application | Face Milling |  | ✓ | ✓ | ✓ | ✓ | ✓ | ✓ |
| | Shoulder Milling |  | ✓ | ✓ | ✓ | ✓ | ✓ | ✓ |
| | Slot Milling |  | ✓ | ✓ | ✓ | ✓ | ✓ | ✓ |
| | Plunging |  | ✓ | ✓ | ✓ | ✓ | ✓ | ✓ |
| | Helical Interpolation |  | ✓ | ✓ | ✓ | ✓ | ✓ | ✓ |
| | Side Profile Milling |  | - | - | - | - | - | - |
| | Profile Milling |  | - | - | - | - | - | - |
| | | | | | | | | |

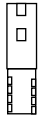













| Insert | | | SDMT 09T3.. WLTR | 490R-08.. SDV | 490R-14.. SDV | SDMT 1506.. WDA | SD.T 09M4.. KRLY | SD.T 1305.. KRLY |
|--------------------|-----------------------|---|---|---|---|---|---|---|
| | | |  |  |  |  |  |  |
| Page | | | F192 | F193 | F193 | F194 | F194 | F194 |
| Dimeter Range (mm) | | | Ø20-32 | Ø20-63 | Ø50-80 | Ø50-125 | Ø25-63 | Ø50-100 |
| Approach Angle | | | 45° | 90° | 90° | 90° | 90° | 90° |
| Max. Cutting Depth | | | 7mm | 5.5mm | 10.6mm | 12mm | 7mm | 11mm |
| Holder Type | Endmills |  | - | ✓ Dia Range (mm) Ø20-33 | - | - | ✓ Dia Range (mm) Ø25-32 | - |
| | Modular Mills |  | ✓ Dia Range (mm) Ø20-32 | ✓ Dia Range (mm) Ø20-32 | - | - | - | - |
| | Face Mills |  | - | ✓ Dia Range (mm) Ø40-63 | ✓ Dia Range (mm) Ø50-80 | ✓ Dia Range (mm) Ø50-125 | ✓ Dia Range (mm) Ø40-63 | ✓ Dia Range (mm) Ø50-100 |
| | Helical Mills |  | - | - | - | - | - | - |
| Application | Face Milling |  | ✓ | ✓ | ✓ | ✓ | ✓ | ✓ |
| | Shoulder Milling |  | ✓ | ✓ | ✓ | ✓ | ✓ | ✓ |
| | Slot Milling |  | ✓ | ✓ | ✓ | ✓ | ✓ | ✓ |
| | Plunging |  | ✓ | ✓ | ✓ | ✓ | ✓ | ✓ |
| | Helical Interpolation |  | ✓ | ✓ | ✓ | ✓ | ✓ | ✓ |
| | Side Profile Milling |  | - | - | - | - | - | - |
| | Profile Milling |  | - | - | - | - | - | - |
| | | | | | | | | |
| | | | | | | | | |

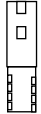













| Insert | | | SYHU 0704.. | SDMT 1205.. PRMT | SN.. 1206.. ISO | SNMU 1305.. KYCR | SNMU 1305.. PNTR | SN.. 1206.. ISO |
|--------------------|-----------------------|---|---|---|---|--|---|---|
| | | |  |  |  |  |  |  |
| Page | | | F197 | F197 | F197 | F198 | F198 | F199 |
| Dimeter Range (mm) | | | Ø50-100 | Ø50-125 | Ø50-200 | Ø50-160 | Ø50-125 | Ø50-315 |
| Approach Angle | | | 50° | 90° | 89° | 88° | 89° | 45° |
| Max. Cutting Depth | | | 4.6mm | 10mm | 10mm | 5mm | 9mm | 6mm |
| Holder Type | Endmills |  | - | - | - | - | - | - |
| | Modular Mills |  | - | - | - | - | - | - |
| | Face Mills |  | ✓ Dia Range (mm) Ø50-100 | ✓ Dia Range (mm) Ø50-125 | ✓ Dia Range (mm) Ø50-200 | ✓ Dia Range (mm) Ø50-160 | ✓ Dia Range (mm) Ø50-125 | ✓ Dia Range (mm) Ø50-315 |
| | Helical Mills |  | - | - | - | - | - | - |
| Application | Face Milling |  | ✓ | ✓ | ✓ | ✓ | ✓ | ✓ |
| | Shoulder Milling |  | ✓ | ✓ | ✓ | ✓ | ✓ | ✓ |
| | Slot Milling |  | ✓ | ✓ | ✓ | ✓ | ✓ | ✓ |
| | Plunging |  | ✓ | ✓ | ✓ | ✓ | ✓ | ✓ |
| | Helical Interpolation |  | ✓ | ✓ | ✓ | ✓ | ✓ | ✓ |
| | Side Profile Milling |  | - | - | - | - | - | - |
| | Profile Milling |  | - | - | - | - | - | - |
| | | | | | | | | |
| | | | | | | | | |

| Insert | | | SEET 12T3 ZCC | SNMU 1305.. | SEMT 13T3 MTSBH | R345-13.. SDV | SNMT 1205.. PRMT | SEET 0903 KRLY |
|--------------------|-----------------------|---|---|---|---|--|---|---|
| | | |  |  |  |  |  |  |
| Page | | | F199 | F200 | F200 | F200 | F201 | F202 |
| Dimeter Range (mm) | | | Ø50-160 | Ø50-100 | Ø50-80 | Ø50-100 | Ø50-160 | Ø25-80 |
| Approach Angle | | | 45° | 45° | 45° | 45° | 45° | 45° |
| Max. Cutting Depth | | | 6mm | 6mm | 6mm | 6mm | 6.5mm | 4mm |
| Holder Type | Endmills |  | - | - | - | - | - | - |
| | Modular Mills |  | - | - | - | - | - | - |
| | Face Mills |  | ✓ Dia Range (mm) Ø50-160 | ✓ Dia Range (mm) Ø50-100 | ✓ Dia Range (mm) Ø50-80 | ✓ Dia Range (mm) Ø50-125 | ✓ Dia Range (mm) Ø50-160 | ✓ Dia Range (mm) Ø50-100 |
| | Helical Mills |  | - | - | - | - | - | - |
| Application | Face Milling |  | ✓ | ✓ | ✓ | ✓ | ✓ | ✓ |
| | Shoulder Milling |  | ✓ | ✓ | ✓ | ✓ | ✓ | ✓ |
| | Slot Milling |  | ✓ | ✓ | ✓ | ✓ | ✓ | ✓ |
| | Plunging |  | ✓ | ✓ | ✓ | ✓ | ✓ | ✓ |
| | Helical Interpolation |  | ✓ | ✓ | ✓ | ✓ | ✓ | ✓ |
| | Side Profile Milling |  | - | - | - | - | - | - |
| | Profile Milling |  | - | - | - | - | - | - |
| | | | | | | | | |
| | | | | | | | | |

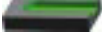
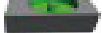

| Insert | | | SE.. 14M4 KRLY | SNMU 1307.. TNGLY | ONMU 0705.. TNGLY | RNMU 1307.. TNGLY | SNEG 1205.. ZCC | SN.X 1306.. TGTC |
|--------------------|-----------------------|---|---|---|---|--|---|---|
| | | |  |  |  |  |  |  |
| Page | | | F202 | F203 | F203 | F203 | F201 | F201 |
| Dimeter Range (mm) | | | Ø50-125 | Ø63-100 | Ø63-100 | Ø63-100 | Ø50-160 | Ø50-80 |
| Approach Angle | | | 45° | 45° | 45° | -° | 45° | 45° |
| Max. Cutting Depth | | | 6.5mm | 6mm | 10mm | 5mm | 7mm | 7mm |
| Holder Type | Endmills |  | - | - | - | - | - | - |
| | Modular Mills |  | - | - | - | - | - | - |
| | Face Mills |  | Dia Range (mm) Ø50-125 ✓ | Dia Range (mm) Ø63-100 ✓ | Dia Range (mm) Ø63-100 ✓ | Dia Range (mm) Ø63-100 ✓ | Dia Range (mm) Ø50-160 ✓ | Dia Range (mm) Ø50-315 ✓ |
| | Helical Mills |  | - | - | - | - | - | - |
| Application | Face Milling |  | ✓ | ✓ | ✓ | ✓ | ✓ | ✓ |
| | Shoulder Milling |  | ✓ | - | - | - | - | - |
| | Slot Milling |  | ✓ | - | - | - | - | - |
| | Plunging |  | - | - | - | - | - | - |
| | Helical Interpolation |  | - | - | - | - | - | - |
| | Side Profile Milling |  | - | - | - | - | - | - |
| | Profile Milling |  | - | - | - | - | - | - |
| | | | | | | | | |
| | | | | | | | | |

| Insert | | | SPKN 1203.. ISO | SNGN 1204.. KYCR | XNMMU 0605.. TGTC | XNMMU 0906.. TGTC | HNKX 0604.. LMN | ON.X 0505.. |
|--------------------|-----------------------|---|---|---|---|--|---|---|
| | | |  |  |  |  |  |  |
| Page | | | F204 | F204 | F205 | F205 | F205 | F205 |
| Dimeter Range (mm) | | | Ø50-315 | Ø63-100 | Ø50-80 | Ø63-125 | Ø50-80 | Ø50-100 |
| Approach Angle | | | 75° | 88° | 45° | 45° | 45° | 45° |
| Max. Cutting Depth | | | 9.5mm | 9.5mm | 3.5mm | 5mm | 3.5mm | 4mm |
| Holder Type | Endmills |  | - | - | - | - | - | - |
| | Modular Mills |  | - | - | - | - | - | - |
| | Face Mills |  | Dia Range (mm) Ø50-315 ✓ | Dia Range (mm) Ø63-100 ✓ | Dia Range (mm) Ø50-80 ✓ | Dia Range (mm) Ø63-125 ✓ | Dia Range (mm) Ø50-80 ✓ | Dia Range (mm) Ø50-100 ✓ |
| | Helical Mills |  | - | - | - | - | - | - |
| Application | Face Milling |  | ✓ | ✓ | ✓ | ✓ | ✓ | ✓ |
| | Shoulder Milling |  | - | - | - | - | - | - |
| | Slot Milling |  | - | - | - | - | - | - |
| | Plunging |  | - | - | - | - | - | - |
| | Helical Interpolation |  | - | - | - | - | - | - |
| | Side Profile Milling |  | - | - | - | - | - | - |
| | Profile Milling |  | - | - | - | - | - | - |
| | | | | | | | | |
| | | | | | | | | |

















| Insert | | | ON.X 0606.. KRLY | PNMU 1205.. KYCR | PNMU 0905.. KYCR | ON.X 0806.. ISO | ONHU 0604.. ZCC | ONHU 08T6.. ZCC |
|--------------------|-----------------------|---|---|---|---|--|---|---|
| | | |  |  |  |  |  |  |
| Page | | | F206 | F206 | F206 | F207 | F207 | F207 |
| Dimeter Range (mm) | | | Ø63-125 | Ø63-125 | Ø50-125 | Ø63-200 | Ø63-100 | Ø63-100 |
| Approach Angle | | | 45° | 45° | 66° | 45° | 45° | 45° |
| Max. Cutting Depth | | | 4mm | 6mm | 6mm | 5.5mm | 4mm | 5mm |
| Holder Type | Endmills |  | - | - | - | - | - | - |
| | Modular Mills |  | - | - | - | - | - | - |
| | Face Mills |  | Dia Range (mm) Ø63-125 ✓ | Dia Range (mm) Ø63-125 ✓ | Dia Range (mm) Ø50-125 ✓ | Dia Range (mm) Ø63-200 ✓ | Dia Range (mm) Ø63-100 ✓ | Dia Range (mm) Ø63-100 ✓ |
| | Helical Mills |  | - | - | - | - | - | - |
| Application | Face Milling |  | ✓ | ✓ | ✓ | ✓ | ✓ | ✓ |
| | Shoulder Milling |  | - | - | - | - | - | - |
| | Slot Milling |  | - | - | - | - | - | - |
| | Plunging |  | - | - | - | - | - | - |
| | Helical Interpolation |  | - | - | - | - | - | - |
| | Side Profile Milling |  | - | - | - | - | - | - |
| | Profile Milling |  | - | - | - | - | - | - |
| | | | | | | | | |
| | | | | | | | | |





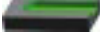









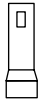

| Insert | | | HN.J 0604.. KNMTL | HN.J 0704.. WDA | HN.J 0905.. KNMTL/WDA | HNGX 0604.. PRMT | HNGX 0906.. PRMT | ONMU 0504.. SCO |
|--------------------|-----------------------|---|---|---|---|--|---|---|
| | | |  |  |  |  |  |  |
| Page | | | F208 | F208 | F208 | F208 | F208 | F209 |
| Dimeter Range (mm) | | | Ø50-80 | Ø50-80 | Ø50-160 | Ø50-100 | Ø63-160 | Ø50-100 |
| Approach Angle | | | 45° | 45° | 45° | 45° | 45° | 45° |
| Max. Cutting Depth | | | 3.23mm | 3.5mm | 4.5mm | 3mm | 5mm | 3mm |
| Holder Type | Endmills |  | - | - | - | - | - | - |
| | Modular Mills |  | - | - | - | - | - | - |
| | Face Mills |  | Dia Range (mm) Ø50-80 ✓ | Dia Range (mm) Ø63-100 ✓ | Dia Range (mm) Ø50-160 ✓ | Dia Range (mm) Ø50-100 ✓ | Dia Range (mm) Ø63-160 ✓ | Dia Range (mm) Ø50-100 ✓ |
| | Helical Mills |  | - | - | - | - | - | - |
| Application | Face Milling |  | ✓ | ✓ | ✓ | ✓ | ✓ | ✓ |
| | Shoulder Milling |  | ✓ | ✓ | ✓ | ✓ | ✓ | ✓ |
| | Slot Milling |  | ✓ | ✓ | ✓ | ✓ | ✓ | ✓ |
| | Plunging |  | - | - | - | - | - | - |
| | Helical Interpolation |  | - | - | - | - | - | - |
| | Side Profile Milling |  | - | - | - | - | - | - |
| | Profile Milling |  | - | - | - | - | - | - |

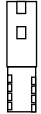
| Insert | | OD.. 0504.. PRMT | OFER 07T3.. ISO | RNMU 1004.. TGTC | RNMU 1205.. TGTC | RNMU 1606.. TGTC | RDKW 0501.. ISO |
|--------------------|---|---|---|---|--|---|---|
| | |  |  |  |  |  |  |
| Page | | F209 | F209 | G210 | G210 | G210 | G211 |
| Dimeter Range (mm) | | Ø40-100 | Ø63-125 | Ø25-50 | Ø32-63 | Ø50-80 | Ø08-14 |
| Approach Angle | | 45° | 43° | -° | -° | -° | -° |
| Max. Cutting Depth | | 3.5mm | 3mm | 5mm | 6mm | 8mm | 2.5mm |
| Holder Type | Endmills  | - | - | ✓ Dia Range (mm) Ø25-32 | ✓ Dia Range (mm) Ø32-40 | - | ✓ Dia Range (mm) Ø08-14 |
| | Modular Mills  | - | - | ✓ Dia Range (mm) Ø25-32 | ✓ Dia Range (mm) Ø32-40 | - | - |
| | Face Mills  | ✓ Dia Range (mm) Ø40-100 | ✓ Dia Range (mm) Ø63-125 | ✓ Dia Range (mm) Ø40-50 | ✓ Dia Range (mm) Ø40-63 | ✓ Dia Range (mm) Ø50-80 | - |
| | Helical Mills  | - | - | - | - | - | - |
| Application | Face Milling  | ✓ | ✓ | ✓ | ✓ | ✓ | ✓ |
| | Shoulder Milling  | ✓ | ✓ | ✓ | ✓ | ✓ | ✓ |
| | Slot Milling  | ✓ | ✓ | ✓ | ✓ | ✓ | ✓ |
| | Plunging  | - | - | ✓ | ✓ | ✓ | ✓ |
| | Helical Interpolation  | - | - | ✓ | ✓ | ✓ | ✓ |
| | Side Profile Milling  | - | - | - | - | - | - |
| | Profile Milling  | - | - | ✓ | ✓ | ✓ | ✓ |
| | | | | | | | |
| | | | | | | | |

| Insert | | | RDKW 0702.. ISO | RD.. 0803.. ISO | RD.. 1003.. ISO | RD.. 12T3.. ISO | RD.. 1604.. ISO | RD.. 10T3 ISO |
|--------------------|-----------------------|---|---|---|---|--|---|---|
| | | |  |  |  |  |  |  |
| Page | | | G211-212 | G211-212 | G211-213 | G211-213 | G213 | G211-213 |
| Dimeter Range (mm) | | | Ø16-25 | Ø16-35 | Ø20-125 | Ø25-125 | Ø63-125 | Ø20-63 |
| Approach Angle | | | -° | -° | -° | -° | -° | -° |
| Max. Cutting Depth | | | 3.5mm | 4mm | 5mm | 6mm | 8mm | 5mm |
| Holder Type | Endmills |  | ✓ Dia Range (mm) Ø16-25 | ✓ Dia Range (mm) Ø16-32 | ✓ Dia Range (mm) Ø20-40 | ✓ Dia Range (mm) Ø25-40 | - | ✓ Dia Range (mm) Ø20-32 |
| | Modular Mills |  | ✓ Dia Range (mm) Ø16-25 | ✓ Dia Range (mm) Ø16-35 | ✓ Dia Range (mm) Ø20-42 | ✓ Dia Range (mm) Ø24-42 | - | ✓ Dia Range (mm) Ø20-32 |
| | Face Mills |  | - | - | ✓ Dia Range (mm) Ø40-125 | ✓ Dia Range (mm) Ø40-125 | ✓ Dia Range (mm) Ø63-125 | ✓ Dia Range (mm) Ø40-63 |
| | Helical Mills |  | - | - | - | - | - | - |
| Application | Face Milling |  | ✓ | ✓ | ✓ | ✓ | ✓ | ✓ |
| | Shoulder Milling |  | ✓ | ✓ | ✓ | ✓ | ✓ | ✓ |
| | Slot Milling |  | ✓ | ✓ | ✓ | ✓ | ✓ | ✓ |
| | Plunging |  | ✓ | ✓ | ✓ | ✓ | ✓ | ✓ |
| | Helical Interpolation |  | ✓ | ✓ | ✓ | ✓ | ✓ | ✓ |
| | Side Profile Milling |  | - | - | - | - | - | - |
| | Profile Milling |  | ✓ | ✓ | ✓ | ✓ | ✓ | ✓ |
| | | | | | | | | |
| | | | | | | | | |

| Insert | | RD.. 1204 ISO | RPMT 10T3 MTSBH | RPMT 1204 MTSBH | RPMT 10T3 KYCR | RPMT 1204 KYCR | RPMT 1605 KYCR |
|--------------------|---|---|---|---|--|---|---|
| | |  |  |  |  |  |  |
| Page | | G211-213 | G214 | G214 | G214 | G214 | G214 |
| Dimeter Range (mm) | | Ø25-100 | Ø25-100 | Ø25-100 | Ø25-63 | Ø32-80 | Ø63-125 |
| Approach Angle | | 6° | -° | -° | -° | -° | -° |
| Max. Cutting Depth | | 6mm | 5mm | 6mm | 5mm | 6mm | 8mm |
| Holder Type | Endmills  | ✓ Dia Range (mm) Ø25-33 | ✓ Dia Range (mm) Ø25-32 | ✓ Dia Range (mm) Ø25 | ✓ Dia Range (mm) Ø25-35 | ✓ Dia Range (mm) Ø32-40 | - |
| | Modular Mills  | ✓ Dia Range (mm) Ø32-42 | ✓ Dia Range (mm) Ø25-42 | ✓ Dia Range (mm) Ø25-42 | ✓ Dia Range (mm) Ø25-32 | ✓ Dia Range (mm) Ø32-40 | - |
| | Face Mills  | ✓ Dia Range (mm) Ø40-100 | ✓ Dia Range (mm) Ø40-100 | ✓ Dia Range (mm) Ø40-100 | ✓ Dia Range (mm) Ø40-63 | ✓ Dia Range (mm) Ø40-80 | ✓ Dia Range (mm) Ø63-125 |
| | Helical Mills  | - | - | - | - | - | - |
| Application | Face Milling  | ✓ | ✓ | ✓ | ✓ | ✓ | ✓ |
| | Shoulder Milling  | ✓ | ✓ | ✓ | ✓ | ✓ | ✓ |
| | Slot Milling  | ✓ | ✓ | ✓ | ✓ | ✓ | ✓ |
| | Plunging  | ✓ | ✓ | ✓ | ✓ | ✓ | ✓ |
| | Helical Interpolation  | ✓ | ✓ | ✓ | ✓ | ✓ | ✓ |
| | Side Profile Milling  | - | - | - | - | - | - |
| | Profile Milling  | ✓ | ✓ | ✓ | ✓ | ✓ | ✓ |
| | | | | | | | |
| | | | | | | | |

| Insert | | | QPMT 10T3 SMTM | RCKT 1204.. SDV | RPNX 10T3.. CRTZ | RPNX 1204.. CRTZ | RCKT 10T3.. ZCC | RCKT 1204.. ZCC |
|--------------------|-----------------------|---|---|---|---|--|---|---|
| | | |  |  |  |  |  |  |
| Page | | | G216 | G217 | G216 | G216 | G217 | G217 |
| Dimeter Range (mm) | | | Ø25-63 | Ø28-80 | Ø40-80 | Ø50-100 | Ø40-63 | Ø50-80 |
| Approach Angle | | | -° | -° | -° | -° | -° | -° |
| Max. Cutting Depth | | | 5mm | 6mm | 5mm | 6mm | 5mm | 6mm |
| Holder Type | Endmills |  | ✓ Dia Range (mm) Ø25-32 | ✓ Dia Range (mm) Ø28-35 | - | - | - | - |
| | Modular Mills |  | ✓ Dia Range (mm) Ø25-40 | - | - | - | - | - |
| | Face Mills |  | ✓ Dia Range (mm) Ø40-63 | ✓ Dia Range (mm) Ø50-80 | ✓ Dia Range (mm) Ø40-80 | ✓ Dia Range (mm) Ø50-100 | ✓ Dia Range (mm) Ø40-63 | ✓ Dia Range (mm) Ø50-80 |
| | Helical Mills |  | - | - | - | - | - | - |
| Application | Face Milling |  | ✓ | ✓ | ✓ | ✓ | ✓ | ✓ |
| | Shoulder Milling |  | ✓ | ✓ | ✓ | ✓ | ✓ | ✓ |
| | Slot Milling |  | ✓ | ✓ | ✓ | ✓ | ✓ | ✓ |
| | Plunging |  | ✓ | ✓ | ✓ | ✓ | ✓ | ✓ |
| | Helical Interpolation |  | ✓ | ✓ | ✓ | ✓ | ✓ | ✓ |
| | Side Profile Milling |  | - | - | - | - | - | - |
| | Profile Milling |  | ✓ | ✓ | ✓ | ✓ | ✓ | ✓ |
| | | | | | | | | |
| | | | | | | | | |

| Insert | | | VCGT 1604.. ISO | VCGT 2205.. ISO | XEKT-MA 19M5.. KRLY | XPHT16R0803 ZCC-CT | XPHT20R10T3 ZCC-CT | XPHT25R1204 ZCC-CT |
|--------------------|-----------------------|---|---|---|---|--|---|---|
| | | |  |  |  |  |  |  |
| Page | | | F196 | F196 | F196 | G218 | G218 | G218 |
| Dimeter Range (mm) | | | Ø40-80 | Ø50-80 | Ø40-63 | Ø16 | Ø20 | Ø25 |
| Approach Angle | | | 90° | 90° | 90° | - | - | - |
| Max. Cutting Depth | | | 11mm | 14mm | 17mm | - | - | - |
| Holder Type | Endmills |  | - | - | - | ✓ Dia Range (mm) Ø16 | ✓ Dia Range (mm) Ø20 | ✓ Dia Range (mm) Ø25 |
| | Modular Mills |  | - | - | - | - | - | - |
| | Face Mills |  | ✓ Dia Range (mm) Ø40-80 | ✓ Dia Range (mm) Ø50-80 | ✓ Dia Range (mm) Ø40-63 | - | - | - |
| | Helical Mills |  | - | - | - | - | - | - |
| Application | Face Milling |  | ✓ | ✓ | ✓ | - | - | - |
| | Shoulder Milling |  | ✓ | ✓ | ✓ | - | - | - |
| | Slot Milling |  | ✓ | ✓ | ✓ | - | - | - |
| | Plunging |  | - | - | - | - | - | - |
| | Helical Interpolation |  | ✓ | ✓ | ✓ | - | - | - |
| | Side Profile Milling |  | - | - | - | - | - | - |
| | Profile Milling |  | - | - | - | ✓ | ✓ | ✓ |
| | | | | | | | | |
| | | | | | | | | |

| Insert | | | P3208 WLTR | P3210 WLTR | P3212 WLTR | P3216 WLTR | P3220 WLTR | P3225 WLTR | P3232 WLTR |
|--------------------|-----------------------|---|---|---|---|---|---|---|---|
| | | |  |  |  |  |  |  |  |
| Page | | | G218 | G218 | G218 | G218 | G218 | G218 | G218 |
| Dimeter Range (mm) | | | Ø8 | Ø10 | Ø12 | Ø16 | Ø20 | Ø25 | Ø32 |
| Approach Angle | | | -° | -° | -° | -° | -° | -° | -° |
| Max. Cutting Depth | | | - | - | - | - | - | - | - |
| Holder Type | Endmills |  | ✓ Dia Range (mm) Ø8 | ✓ Dia Range (mm) Ø10 | ✓ Dia Range (mm) Ø12 | ✓ Dia Range (mm) Ø16 | ✓ Dia Range (mm) Ø20 | ✓ Dia Range (mm) Ø25 | ✓ Dia Range (mm) Ø32 |
| | Modular Mills |  | - | - | - | - | - | - | - |
| | Face Mills |  | - | - | - | - | - | - | - |
| | Helical Mills |  | - | - | - | - | - | - | - |
| Application | Face Milling |  | - | - | - | - | - | - | - |
| | Shoulder Milling |  | - | - | - | - | - | - | - |
| | Slot Milling |  | - | - | - | - | - | - | - |
| | Plunging |  | - | - | - | - | - | - | - |
| | Helical Interpolation |  | - | - | - | - | - | - | - |
| | Side Profile Milling |  | - | - | - | - | - | - | - |
| | Profile Milling |  | ✓ | ✓ | ✓ | ✓ | ✓ | ✓ | ✓ |
| | | | | | | | | | |

A Type

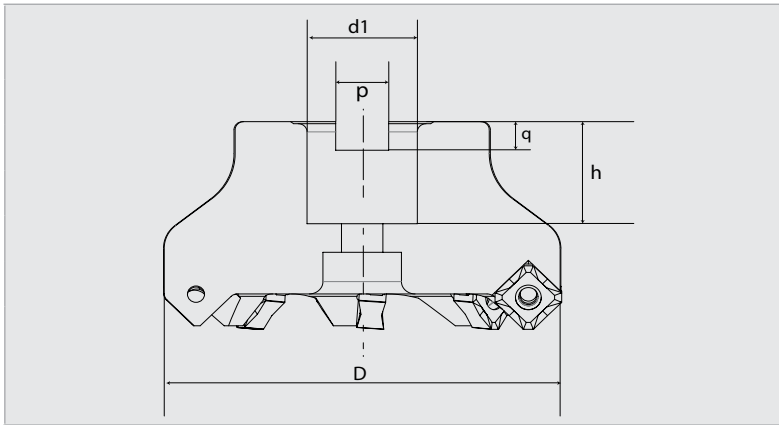

| D | d1 | d2 | p | q | h |
|-----|----|----|------|-----|----|
| 40 | 16 | - | 8.4 | 5.6 | 20 |
| 50 | 22 | - | 10.4 | 6.3 | 22 |
| 63 | 22 | - | 10.4 | 6.3 | 22 |
| 80 | 27 | - | 12.4 | 7 | 25 |
| 100 | 32 | - | 14.4 | 8 | 26 |

B Type

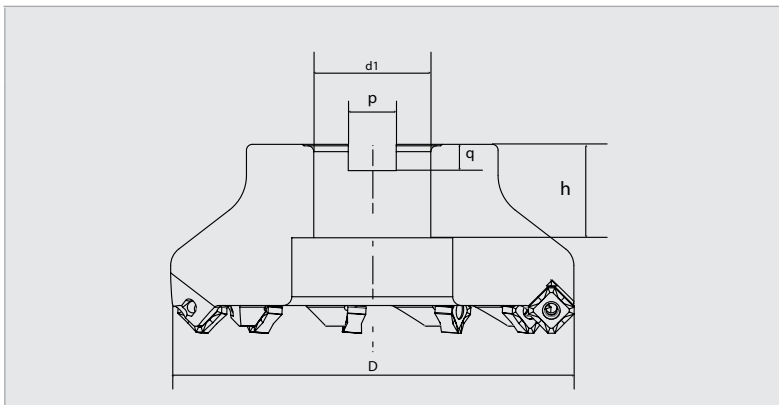

| D | d1 | d2 | p | q | h |
|-----|----|----|------|---|----|
| 125 | 40 | - | 16.4 | 9 | 32 |

C Type

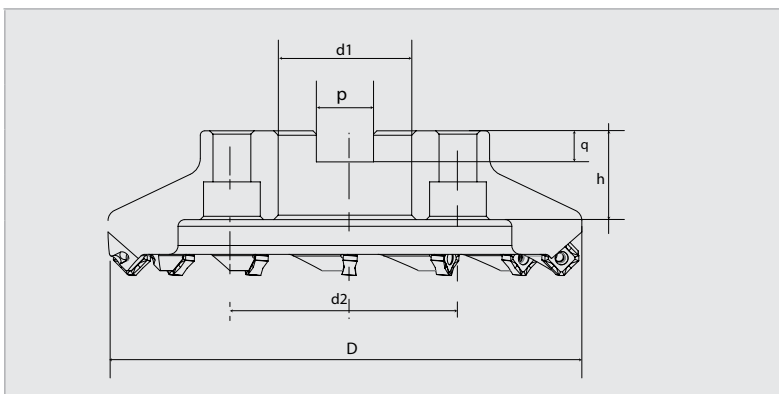

| D | d1 | d2 | p | q | h |
|-----|----|-------|------|----|----|
| 160 | 40 | 66.7 | 16.4 | 9 | 32 |
| 200 | 60 | 101.6 | 25.7 | 14 | 40 |
| 250 | 60 | 101.6 | 25.7 | 14 | 40 |

D Type

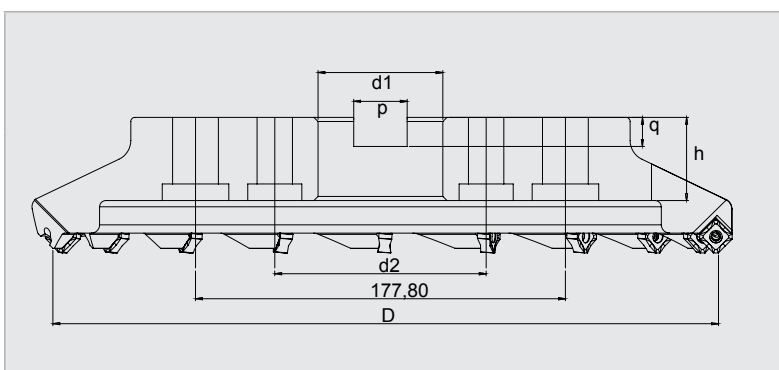

| D | d1 | d2 | p | q | h |
|-----|----|-------|------|----|----|
| 315 | 60 | 101.6 | 25.7 | 14 | 40 |



Milling Tools

| Ordering Code | Item Designation | | Price | Master Insert* |
|---------------|---------------------------------|---|-------------|----------------|
| | ST90 APKT 1003.. ISO | | <i>EURO</i> | |
| SM12493 | ST90 AP10 D12 W12 L120 Z01 | - | 46 € | APKT 1003.. |
| SM12172 | ST90 AP10 D12 W16 L120 Z01 | - | 46 € | |
| SM12189 | ST90 AP10 D14 W16 L120 Z01 | - | 48 € | |
| SM01729 | ST90 AP10 D16 W16 L100 Z02-H | ✓ | 55 € | |
| SM12196 | ST90 AP10 D16 W16 L120 Z02 | - | 55 € | |
| SM12486 | ST90 AP10 D16 W16 L120 Z02-H | ✓ | 59 € | |
| SM12264 | ST90 AP10 D16 W16 L150 Z02 | - | 75 € | |
| SM27794 | ST90 AP10 D16 W16 L150 Z02-H | ✓ | 78 € | |
| SM12318 | ST90 AP10 D16 C16 L200 Z02 | - | 73 € | |
| SM38592 | ST90 AP10 D16 C16 L200 Z02-H | ✓ | 80 € | |
| SM38639 | ST90 AP10 D17 W16 L150 Z02 | - | 75 € | |
| SM38585 | ST90 AP10 D17 C16 L200 Z02 | - | 80 € | |
| SM12202 | ST90 AP10 D18 W16 L120 Z02 | - | 55 € | |
| SM12271 | ST90 AP10 D18 W16 L150 Z02 | - | 75 € | |
| SM38578 | ST90 AP10 D18 C16 L200 Z02-H | ✓ | 91 € | |
| SM12325 | ST90 AP10 D18 C16 L200 Z02 | - | 80 € | |
| SM01736 | ST90 AP10 D20 W20 L100 Z03-H | ✓ | 61 € | |
| SM12219 | ST90 AP10 D20 W20 L120 Z03 | - | 61 € | |
| SM12394 | ST90 AP10 D20 W20 L120 Z03-H | ✓ | 66 € | |
| SM12288 | ST90 AP10 D20 W20 L150 Z03 | - | 77 € | |
| SM38622 | ST90 AP10 D20 W20 L150 Z03-H | ✓ | 80 € | |
| SM38561 | ST90 AP10 D20 C20 L200 Z03-H | ✓ | 106 € | |
| SM12349 | ST90 AP10 D20 C20 L200 Z03 | - | 91 € | |
| SM38615 | ST90 AP10 D21 W20 L150 Z03 | - | 77 € | |
| SM38554 | ST90 AP10 D21 C20 L200 Z03 | - | 105 € | |
| SM12226 | ST90 AP10 D22 W20 L120 Z03 | - | 61 € | |
| SM12295 | ST90 AP10 D22 W20 L150 Z03 | - | 77 € | |
| SM12356 | ST90 AP10 D22 C20 L200 Z03 | - | 96 € | |
| SM12370 | ST90 AP10 D23 W20 L120 Z03 | - | 63 € | |
| SM12233 | ST90 AP10 D24 W20 L120 Z03 | - | 63 € | |
| SM12387 | ST90 AP10 D24 W20 L150 Z03 | - | 84 € | |
| SM26889 | ST90 AP10 D24 C20 L200 Z03 | - | 100 € | |
| SM01743 | ST90 AP10 D25 W25 L100 Z03-H | ✓ | 68 € | |
| SM12240 | ST90 AP10 D25 W25 L120 Z03 | - | 68 € | |
| SM12417 | ST90 AP10 D25 W25 L120 Z03-H | ✓ | 75 € | |
| SM12332 | ST90 AP10 D25 W25 L150 Z03 | - | 84 € | |
| SM38608 | ST90 AP10 D25 W25 L150 Z03-H | ✓ | 90 € | |
| SM12363 | ST90 AP10 D25 C25 L200 Z03 | - | 100 € | |
| SM12479 | ST90 AP10 D25 C25 L250 Z03 | - | 117 € | |
| SM12509 | ST90 AP10 D26 W25 L120 Z03-H | ✓ | 75 € | |
| SM12516 | ST90 AP10 D26 W25 L150 Z03 | - | 84 € | |
| SM12523 | ST90 AP10 D26 C25 L200 Z03 | - | 100 € | |
| SM12165 | ST90 AP10 D30 W25 L120 Z04 | - | 75 € | |
| SM12455 | ST90 AP10 D30 W25 L150 Z04 | - | 87 € | |
| SM12400 | ST90 AP10 D32 W25 L120 Z04 | - | 80 € | |
| SM12257 | ST90 AP10 D32 W32 L120 Z04 | - | 75 € | |
| SM12424 | ST90 AP10 D32 W32 L120 Z04-H | ✓ | 90 € | |
| SM12431 | ST90 AP10 D32 W25 L150 Z04 | - | 87 € | |
| SM12448 | ST90 AP10 D32 W32 L150 Z04 | - | 80 € | |
| SM24113 | ST90 AP10 D32 C32 L300 Z04 | - | 158 € | |
| SM12301 | ST90 AP10 D35 W32 L120 Z05 | - | 87 € | |
| SM12158 | ST90 AP10 D40 W32 L120 Z05 | - | 92 € | |
| SM12462 | ST90 AP10 D40 W32 L150 Z05 | - | 91 € | |



| Ordering Code | Item Designation | | Price | Master Insert* |
|---------------|---------------------------------|---|-------------|----------------|
| | MT90 APKT 1003.. ISO | | EURO | |
| SM15586 | MT90 AP10 D16 M08 L25 Z02-H | ✓ | 85 € | APKT 1003.. |
| SM15593 | MT90 AP10 D20 M10 L30 Z03-H | ✓ | 88 € | |
| SM15609 | MT90 AP10 D25 M12 L35 Z03-H | ✓ | 94 € | |
| SM15616 | MT90 AP10 D32 M16 L43 Z04-H | ✓ | 102 € | |
| SM15623 | MT90 AP10 D40 M16 L43 Z05-H | ✓ | 107 € | |
| SM15630 | MT90 AP10 D42 M16 L43 Z05-H | ✓ | 111 € | |



| Ordering Code | Item Designation | | Price | Master Insert* |
|---------------|---------------------------------|---|-------------|----------------|
| | TK90 APKT 1003.. ISO | | EURO | |
| SM29309 | TK90 AP10 D40 A16 Z05-H | ✓ | 75 € | APKT 1003.. |
| SM13995 | TK90 AP10 D40 A16 Z05 | - | 70 € | |
| SM29293 | TK90 AP10 D50 A22 Z06-H | ✓ | 92 € | |
| SM14008 | TK90 AP10 D50 A22 Z06 | - | 85 € | |
| SM29286 | TK90 AP10 D63 A22 Z07-H | ✓ | 107 € | |
| SM14015 | TK90 AP10 D63 A22 Z07 | - | 100 € | |
| SM29279 | TK90 AP10 D80 A27 Z08-H | ✓ | 118 € | |
| SM14022 | TK90 AP10 D80 A27 Z08 | - | 127 € | |
| SM29262 | TK90 AP10 D100 A32 Z09-H | ✓ | 140 € | |
| SM14039 | TK90 AP10 D100 A32 Z09 | - | 147 € | |
| SM13988 | TK90 AP10 D125 B40 Z11 | - | 209 € | |

Cooling mounting screw is optional / See Page 294 for cooling mounting screws.
İçten su vermeli montaj vidaları opsiyoneldir. / Bkz. Sayfa 294 İçten su vermeli montaj vidaları için.



| Ordering Code | Item Designation | | Price | Master Insert* |
|---------------|--|---|-------------|----------------|
| | HT90 APKT 1003.. HELICAL CUTTER ISO | | EURO | |
| SM15777 | HT90 AP10 D20 L87 A20 Z06 | - | 222 € | APKT 1003.. |
| SM15784 | HT90 AP10 D25 L105 A25 Z08-H | ✓ | 268 € | |
| SM15791 | HT90 AP10 D32 L115 A32 Z15-H | ✓ | 345 € | |
| SM15807 | HT90 AP10 D40 L130 A32 Z18-H | ✓ | 383 € | |



| Size Designation | Master Insert* | Spare Parts | | |
|------------------|----------------|--|----------|--------------------|
| | | Screw | Torx Key | Screw Torque Value |
| D12 - D14 | APKT 1003.. | | | N-m |
| D16 - D125 | | SSV M2.5x5- 9504 SSV M2.5x6- 9505 | | |

*Suitable Insert brand is ISO.



| Ordering Code | Item Designation | | Price | Master Insert* |
|---------------|---------------------------------|---|-------------|----------------|
| | ST90 APKT 1604.. ISO | | <i>EURO</i> | |
| SM12783 | ST90 AP16 D25 W25 L120 Z02 | - | 61 € | APKT 1604.. |
| SM57043 | ST90 AP16 D25 W25 L120 Z02-H | ✓ | 72 € | |
| SM12875 | ST90 AP16 D25 W25 L150 Z02 | - | 80 € | |
| SM57050 | ST90 AP16 D25 W25 L150 Z02-H | ✓ | 90 € | |
| SM12929 | ST90 AP16 D25 C25 L200 Z02 | - | 92 € | |
| SM24137 | ST90 AP16 D25 C25 L250 Z02 | - | 124 € | |
| SM12790 | ST90 AP16 D26 W25 L120 Z02 | - | 61 € | |
| SM57067 | ST90 AP16 D26 W25 L120 Z02-H | ✓ | 72 € | |
| SM12950 | ST90 AP16 D26 W25 L150 Z02 | - | 80 € | |
| SM13001 | ST90 AP16 D26 C25 L200 Z02 | - | 92 € | |
| SM12806 | ST90 AP16 D28 W25 L120 Z02 | - | 64 € | |
| SM12967 | ST90 AP16 D28 W25 L150 Z02 | - | 80 € | |
| SM13018 | ST90 AP16 D28 C25 L200 Z02 | - | 97 € | |
| SM12868 | ST90 AP16 D30 W25 L120 Z03 | - | 64 € | |
| SM57074 | ST90 AP16 D30 W25 L120 Z03-H | ✓ | 75 € | |
| SM12882 | ST90 AP16 D30 W25 L150 Z03 | - | 85 € | |
| SM12769 | ST90 AP16 D30 C25 L200 Z03 | - | 100 € | |
| SM13032 | ST90 AP16 D32 W25 L120 Z03 | - | 68 € | |
| SM12813 | ST90 AP16 D32 W32 L120 Z03 | - | 66 € | |
| SM57081 | ST90 AP16 D32 W32 L120 Z03-H | ✓ | 77 € | |
| SM12899 | ST90 AP16 D32 W32 L150 Z03 | - | 88 € | |
| SM12974 | ST90 AP16 D32 W25 L150 Z03 | - | 86 € | |
| SM12752 | ST90 AP16 D32 C32 L200 Z03 | - | 100 € | |
| SM24120 | ST90 AP16 D32 C32 L250 Z03 | - | 130 € | |
| SM24106 | ST90 AP16 D32 C32 L300 Z03 | - | 139 € | |
| SM12820 | ST90 AP16 D34 W32 L120 Z03 | - | 69 € | |
| SM12981 | ST90 AP16 D34 W32 L150 Z03 | - | 86 € | |
| SM13025 | ST90 AP16 D34 C32 L200 Z03 | - | 102 € | |
| SM12943 | ST90 AP16 D35 W32 L120 Z03 | - | 72 € | |
| SM12905 | ST90 AP16 D35 W32 L150 Z03 | - | 88 € | |
| SM12936 | ST90 AP16 D35 C32 L200 Z03 | - | 105 € | |
| SM12837 | ST90 AP16 D36 W32 L120 Z03 | - | 72 € | |
| SM12844 | ST90 AP16 D38 W32 L120 Z04 | - | 77 € | |
| SM12851 | ST90 AP16 D40 W32 L120 Z04 | - | 77 € | |
| SM12998 | ST90 AP16 D40 W25 L150 Z04 | - | 97 € | |
| SM12912 | ST90 AP16 D40 W32 L150 Z04 | - | 94 € | |
| SM12776 | ST90 AP16 D40 C32 L200 Z04 | - | 121 € | |





| Ordering Code | Item Designation | | Price | Master Insert* |
|---------------|---------------------------------|---|-------------|----------------|
| | MT90 APKT 1604.. ISO | | EURO | |
| SM23833 | MT90 AP16 D25 M12 L35 Z02-H | ✓ | 94 € | APKT 1604.. |
| SM23840 | MT90 AP16 D32 M16 L43 Z03-H | ✓ | 102 € | |
| SM23857 | MT90 AP16 D40 M16 L43 Z04-H | ✓ | 107 € | |
| SM23864 | MT90 AP16 D42 M16 L43 Z04-H | ✓ | 111 € | |



| Ordering Code | Item Designation | | Price | Master Insert* |
|---------------|---------------------------------|---|-------------|----------------|
| | TK90 APKT 1604.. ISO | | EURO | |
| SM29255 | TK90 AP16 D40 A16 Z04-H | ✓ | 70 € | APKT 1604.. |
| SM14046 | TK90 AP16 D40 A16 Z04 | - | 65 € | |
| SM29248 | TK90 AP16 D50 A22 Z05-H | ✓ | 89 € | |
| SM14053 | TK90 AP16 D50 A22 Z05 | - | 84 € | |
| SM29231 | TK90 AP16 D63 A22 Z06-H | ✓ | 105 € | |
| SM14060 | TK90 AP16 D63 A22 Z06 | - | 100 € | |
| SM29224 | TK90 AP16 D80 A27 Z07-H | ✓ | 120 € | |
| SM14077 | TK90 AP16 D80 A27 Z07 | - | 115 € | |
| SM29217 | TK90 AP16 D100 A32 Z08-H | ✓ | 144 € | |
| SM14084 | TK90 AP16 D100 A32 Z08 | - | 139 € | |
| SM14091 | TK90 AP16 D125 B40 Z09 | - | 209 € | |
| SM14107 | TK90 AP16 D160 C40 Z10 | - | 272 € | |
| SM14114 | TK90 AP16 D200 C60 Z12 | - | 435 € | |

Cooling mounting screw is optional / See Page 294 for cooling mounting screws.
İçten su vermeli montaj vidaları opsiyoneldir. / Bkz. Sayfa 294 İçten su vermeli montaj vidaları için.



| Size Designation | Master Insert* | Spare Parts | | |
|------------------|----------------|--------------------|--------------|--------------------|
| | | Screw | Torx Key | Screw Torque Value |
| | | | | |
| D25 - D200 | APKT 1604.. | SSV M4x9x5-9528 | STK-T15-9910 | 4,3 |

*Suitable Insert brand is ISO.

| Ordering Code | Item Designation | | Price | Master Insert* |
|---|------------------------------|---|-------------|----------------|
| | | | | |
| ST90 APMT 0602.. - 11T3 KRLY | | | <i>EURO</i> | |
| SM35232 | ST90 AP06 D10 C10 L120 Z02 | - | 81 € | APMT 0602.. |
| SM35249 | ST90 AP06 D12 C12 L120 Z02 | - | 81 € | |
| SM12547 | ST90 AP11 D16 W16 L120 Z02 | - | 56 € | APMT 11T3.. |
| SM51713 | ST90 AP11 D16 W16 L120 Z02-H | ✓ | 64 € | |
| SM12592 | ST90 AP11 D16 W16 L150 Z02 | - | 76 € | |
| SM51744 | ST90 AP11 D16 W16 L150 Z02-H | ✓ | 87 € | |
| SM12615 | ST90 AP11 D16 C16 L200 Z02 | - | 80 € | |
| SM12554 | ST90 AP11 D20 W20 L120 Z03 | - | 73 € | |
| SM51720 | ST90 AP11 D20 W20 L120 Z03-H | ✓ | 84 € | |
| SM12608 | ST90 AP11 D20 W20 L150 Z03 | - | 80 € | |
| SM51751 | ST90 AP11 D20 W20 L150 Z03-H | ✓ | 91 € | |
| SM12530 | ST90 AP11 D20 C20 L200 Z03 | - | 92 € | |
| SM12561 | ST90 AP11 D25 W25 L120 Z03 | - | 76 € | |
| SM51737 | ST90 AP11 D25 W25 L120 Z03-H | ✓ | 88 € | |
| SM12622 | ST90 AP11 D25 W25 L150 Z03 | - | 84 € | |
| SM51768 | ST90 AP11 D25 W25 L150 Z03-H | ✓ | 96 € | |
| SM12660 | ST90 AP11 D25 C25 L200 Z03 | - | 101 € | |
| SM12578 | ST90 AP11 D26 W25 L120 Z03 | - | 76 € | |
| SM12639 | ST90 AP11 D26 W25 L150 Z03 | - | 87 € | |
| SM12677 | ST90 AP11 D26 C25 L200 Z03 | - | 101 € | |
| SM12585 | ST90 AP11 D32 W32 L120 Z04 | - | 84 € | |
| SM12653 | ST90 AP11 D32 W32 L150 Z04 | - | 87 € | |
| SM12684 | ST90 AP11 D32 C32 L200 Z04 | - | 119 € | |



| Ordering Code | Item Designation | | Price | Master Insert* |
|----------------------------------|-----------------------------|---|-------------|----------------|
| | | | | |
| MT90 APMT 11T3.. KRLY | | | <i>EURO</i> | |
| SM51928 | MT90 AP11 D16 M08 L25 Z02-H | ✓ | 85 € | APMT 11T3.. |
| SM51935 | MT90 AP11 D20 M10 L30 Z03-H | ✓ | 88 € | |
| SM51942 | MT90 AP11 D25 M12 L35 Z04-H | ✓ | 94 € | |



| Ordering Code | Item Designation | | Price | Master Insert* |
|----------------------------------|-------------------------|---|-------------|----------------|
| | | | | |
| TK90 APMT 11T3.. KRLY | | | <i>EURO</i> | |
| SM46122 | TK90 AP11 D40 A16 Z05-H | ✓ | 101 € | APMT 11T3.. |
| SM46139 | TK90 AP11 D50 A22 Z06-H | ✓ | 121 € | |
| SM46146 | TK90 AP11 D63 A22 Z07-H | ✓ | 132 € | |
| SM46153 | TK90 AP11 D80 A27 Z08-H | ✓ | 149 € | |



Cooling mounting screw is optional / See Page 294 for cooling mounting screws.
İçten su vermeli montaj vidaları opsiyoneldir. / Bkz. Sayfa 294 İçten su vermeli montaj vidaları için.

| Size Designation | Master Insert* | Spare Parts | | |
|------------------|----------------|--|----------------------|--------------------|
| | | Screw | Torx Key | Screw Torque Value |
| D10 - D12 | | | | |
| D16 - D32 | APMT 11T3.. | SSV M1.8x4- 9501 | STK-T06- 9906 | 0,6 |
| D40 - D80 | | SSV M2.5x6- 9505 SSV M2.5x7- 9506 | STK-T08- 9908 | 1,2 |

*Suitable Insert brand is KRLY.



| Ordering Code | Item Designation | | Price | Master Insert* |
|---------------|--------------------------------|---|-------------|----------------|
| | ST90 APMT 1135.. | | EURO | |
| SM51775 | ST90 APMT11 D16 W16 L120 Z02-H | ✓ | 64 € | APMT 1135.. |
| SM47648 | ST90 APMT11 D16 W16 L150 Z02-H | ✓ | 87 € | |
| SM01231 | ST90 APMT11 D16 C16 L200 Z02 | - | 80 € | |
| SM51812 | ST90 APMT11 D17 W16 L150 Z02-H | ✓ | 87 € | |
| SM51867 | ST90 APMT11 D17 C16 L200 Z02 | - | 80 € | |
| SM51782 | ST90 APMT11 D18 W16 L120 Z02-H | ✓ | 64 € | |
| SM51829 | ST90 APMT11 D18 W16 L150 Z02-H | ✓ | 87 € | |
| SM51799 | ST90 APMT11 D20 W20 L120 Z03-H | ✓ | 84 € | |
| SM47655 | ST90 APMT11 D20 W20 L150 Z03-H | ✓ | 91 € | |
| SM51874 | ST90 APMT11 D20 C20 L200 Z03 | - | 92 € | |
| SM51836 | ST90 APMT11 D21 W20 L150 Z03-H | ✓ | 91 € | |
| SM51881 | ST90 APMT11 D21 C20 L200 Z03 | - | 92 € | |
| SM51805 | ST90 APMT11 D25 W25 L120 Z04-H | ✓ | 88 € | |
| SM47662 | ST90 APMT11 D25 W25 L150 Z04-H | ✓ | 96 € | |
| SM51898 | ST90 APMT11 D25 C25 L200 Z04 | - | 101 € | |
| SM51843 | ST90 APMT11 D26 W25 L150 Z04-H | ✓ | 96 € | |
| SM51904 | ST90 APMT11 D26 C25 L200 Z04 | - | 101 € | |



| Ordering Code | Item Designation | | Price | Master Insert* |
|---------------|-------------------------------|---|-------------|----------------|
| | MT90 APMT 1135.. | | EURO | |
| SM47709 | MT90 APMT11 D16 M08 L25 Z02-H | ✓ | 85 € | APMT 1135.. |
| SM47716 | MT90 APMT11 D20 M10 L30 Z03-H | ✓ | 88 € | |
| SM47723 | MT90 APMT11 D25 M12 L35 Z04-H | ✓ | 91 € | |
| SM00876 | MT90 APMT11 D32 M16 L43 Z04-H | ✓ | 112 € | |



| Ordering Code | Item Designation | | Price | Master Insert* |
|---------------|---------------------------|---|-------------|----------------|
| | TK90 APMT 1135.. | | EURO | |
| SM47679 | TK90 APMT11 D40 A16 Z05-H | ✓ | 68 € | APMT 1135.. |
| SM47686 | TK90 APMT11 D50 A22 Z06-H | ✓ | 86 € | |
| SM50181 | TK90 APMT11 D63 A22 Z07-H | ✓ | 102 € | |
| SM50198 | TK90 APMT11 D80 A27 Z08-H | ✓ | 117 € | |

Cooling mounting screw is optional / See Page 294 for cooling mounting screws.
İçten su vermeli montaj vidaları opsiyoneldir. / Bkz. Sayfa 294 İçten su vermeli montaj vidaları için.

| Size Designation | Master Insert* | Spare Parts | | |
|------------------|----------------|--|----------|--------------------|
| | | Screw | Torx Key | Screw Torque Value |
| D16 - D26 | APMT 1135.. | | | N-m |
| D40 - D80 | | SSV M2.5x6-9505 SSV M2.5x7-9506 | | |

*Suitable Insert brand is YG-1.



| Ordering Code | Item Designation | | Price | Master Insert* |
|---|--------------------------------|---|-------------|----------------|
| <i>ST90 APKT 09T3.. - 1204.. / 1705..</i> | | | <i>EURO</i> | |
| SM32637 | ST90 AP09T3 D16 W16 L150 Z02-H | ✓ | 78 € | APKT 09T3.. |
| SM32644 | ST90 AP09T3 D16 C16 L200 Z02 | - | 81 € | |
| SM32620 | ST90 AP09T3 D20 W20 L150 Z03-H | ✓ | 80 € | |
| SM32651 | ST90 AP09T3 D20 C20 L200 Z03 | - | 89 € | |
| SM12691 | ST90 AP12 D20 W20 L150 Z02 | - | 81 € | APKT 1204.. |
| SM12707 | ST90 AP12 D21 W20 L150 Z02 | - | 81 € | |
| SM12721 | ST90 AP12 D21 C20 L200 Z02 | - | 95 € | |
| SM12714 | ST90 AP12 D25 W25 L150 Z03 | - | 85 € | |
| SM12738 | ST90 AP12 D26 C25 L200 Z03 | - | 107 € | |
| SM12646 | ST90 AP12 D32 W32 L150 Z04 | - | 89 € | APKT 1705.. |
| SM13049 | ST90 AP17 D25 W25 L120 Z02 | - | 61 € | |
| SM13063 | ST90 AP17 D26 C25 L200 Z02 | - | 110 € | |
| SM13070 | ST90 AP17 D26 C25 L250 Z02 | - | 130 € | |
| SM13087 | ST90 AP17 D30 C25 L300 Z02 | - | 130 € | |
| SM13056 | ST90 AP17 D32 W32 L150 Z03 | - | 85 € | |



| Ordering Code | Item Designation | | Price | Master Insert* |
|----------------------------------|-----------------------------|---|-------------|----------------|
| <i>MT90 APKT 09T3.. - 1204..</i> | | | <i>EURO</i> | |
| SM56138 | MT90 AP09 D16 M08 L25 Z02-H | ✓ | 90 € | APKT 09T3.. |
| SM56145 | MT90 AP09 D20 M10 L30 Z03-H | ✓ | 92 € | |
| SM56329 | MT90 AP12 D20 M10 L30 Z02-H | ✓ | 92 € | APKT 1204.. |
| SM56336 | MT90 AP12 D25 M12 L35 Z03-H | ✓ | 100 € | |
| SM56343 | MT90 AP12 D32 M16 L43 Z04-H | ✓ | 105 € | |



| Ordering Code | Item Designation | | Price | Master Insert* |
|----------------------------------|--------------------------|---|-------------|----------------|
| <i>TK90 APKT 1204.. / 1705..</i> | | | <i>EURO</i> | |
| SM54240 | TK90 AP12 D40 A16 Z05-H | ✓ | 107 € | APKT 1204.. |
| SM54257 | TK90 AP12 D50 A22 Z06-H | ✓ | 120 € | |
| SM54264 | TK90 AP12 D63 A22 Z07-H | ✓ | 135 € | |
| SM28852 | TK90 AP17 D50 A22 Z05-H | ✓ | 86 € | APKT 1705.. |
| SM28845 | TK90 AP17 D63 A22 Z06-H | ✓ | 100 € | |
| SM28838 | TK90 AP17 D80 A27 Z07-H | ✓ | 116 € | |
| SM28821 | TK90 AP17 D100 A32 Z09-H | ✓ | 138 € | |

Cooling mounting screw is optional / See Page 294 for cooling mounting screws.
İçten su vermeli montaj vidaları opsiyoneldir. / Bkz. Sayfa 294 İçten su vermeli montaj vidaları için.

| Size Designation | Master Insert* | Spare Parts | | |
|------------------|----------------|---------------------------|------------------|--------------------|
| | | Screw | Torx Key | Screw Torque Value |
| D16 | APKT 09T3..** | SSV M2.5x5-9504 | STK-T08-9908 | 1,2 |
| D20 | | SSV M2.5x6-9505 | | |
| D20 - D63 | APKT 1204..** | SSV M3.5x8-SC-9513 | STK-T10-9909 | 2,9 |
| D25 - D100 | APKT 1705..** | SSV M4x10-9514 | STK-T15-9910 | 3,0 |

**Body corners should be modified for R2 and more radius inserts / R2 ve üstü radyüslü uçlarda takımın modifiye edilmesi gerekmektedir.

*Suitable Insert brand is TGTC.



| Ordering Code | Item Designation | | Price | Master Insert* |
|---------------|--------------------------------|---|-------|----------------|
| | ST90 APKT 11T3.. | | EURO | |
| SM44159 | ST90 APKT11 D16 W16 L150 Z02-H | ✓ | 105 € | APKT 11T3.. |
| SM49697 | ST90 APKT11 D17 W16 L150 Z02-H | ✓ | 105 € | |
| SM44166 | ST90 APKT11 D20 W20 L150 Z03-H | ✓ | 110 € | |
| SM49703 | ST90 APKT11 D21 W20 L150 Z03-H | ✓ | 110 € | |
| SM44173 | ST90 APKT11 D25 W25 L150 Z04-H | ✓ | 116 € | |
| SM49710 | ST90 APKT11 D26 W25 L150 Z04-H | ✓ | 116 € | |
| SM44180 | ST90 APKT11 D32 W32 L150 Z04-H | ✓ | 122 € | |



| Ordering Code | Item Designation | | Price | Master Insert* |
|---------------|-------------------------------|---|-------|----------------|
| | MT90 APKT 11T3.. | | EURO | |
| SM46344 | MT90 APKT11 D16 M08 L25 Z02-H | ✓ | 85 € | APKT 11T3.. |
| SM46351 | MT90 APKT11 D20 M10 L30 Z03-H | ✓ | 88 € | |
| SM46368 | MT90 APKT11 D25 M12 L35 Z04-H | ✓ | 94 € | |



| Ordering Code | Item Designation | | Price | Master Insert* |
|---------------|---------------------------|---|-------|----------------|
| | TK90 APKT 11T3.. | | EURO | |
| SM44883 | TK90 APKT11 D40 A16 Z05-H | ✓ | 101 € | APKT 11T3.. |
| SM44890 | TK90 APKT11 D50 A22 Z06-H | ✓ | 121 € | |
| SM44906 | TK90 APKT11 D63 A22 Z07-H | ✓ | 132 € | |

Cooling mounting screw is optional / See Page 294 for cooling mounting screws.
İçten su vermeli montaj vidaları opsiyoneldir. / Bkz. Sayfa 294 İçten su vermeli montaj vidaları için.



| Size Designation | Master Insert* | Spare Parts | | |
|------------------|----------------|--|----------|--------------------|
| | | Screw | Torx Key | Screw Torque Value |
| D16 - D32 | APKT 11T3.. | | | N-m |
| D40 - D63 | | SSV M2.5x6-9505 SSV M2.5x7-9506 | | |

*Suitable Insert brand is ZCC-CT.



| Ordering Code | Item Designation | | Price | Master Insert* |
|---|---------------------------------|---|-------------|----------------|
| <i>ST90 R390.0702.. / R390.11T3.. / R390.1704</i> | | | <i>EURO</i> | |
| SM58101 | ST90 R390.07 D10 W10 L100 Z02-H | | 101 € | R390-0702.. |
| SM58118 | ST90 R390.07 D12 W12 L100 Z02-H | | 101 € | |
| SM58125 | ST90 R390.07 D14 W12 L100 Z03-H | | 101 € | |
| SM58132 | ST90 R390.07 D16 W16 L110 Z04-H | | 101 € | |
| SM29873 | ST90 R390.11 D16 W16 L100 Z02-H | | 65 € | R390-11T3.. |
| SM13780 | ST90 R390.11 D16 W16 L150 Z02 | - | 73 € | |
| SM13797 | ST90 R390.11 D16 W16 L150 Z02-H | | 83 € | |
| SM13759 | ST90 R390.11 D20 W20 L100 Z03-H | | 68 € | |
| SM27053 | ST90 R390.11 D20 W20 L110 Z03-H | | 68 € | |
| SM13803 | ST90 R390.11 D20 W20 L150 Z03 | - | 78 € | |
| SM13810 | ST90 R390.11 D20 W20 L150 Z03-H | | 88 € | |
| SM37885 | ST90 R390.11 D25 W25 L100 Z03-H | | 76 € | |
| SM13827 | ST90 R390.11 D25 W25 L150 Z03 | - | 83 € | R390-1704.. |
| SM13858 | ST90 R390.11 D25 W25 L150 Z03-H | | 97 € | |
| SM13834 | ST90 R390.17 D25 W25 L150 Z02 | - | 83 € | |
| SM13865 | ST90 R390.17 D25 W25 L150 Z02-H | | 97 € | |
| SM13841 | ST90 R390.17 D30 W25 L150 Z03 | - | 88 € | |
| SM13872 | ST90 R390.17 D30 W25 L150 Z03-H | | 99 € | |



| Ordering Code | Item Designation | | Price | Master Insert* |
|-------------------------|--------------------------------|--|-------------|----------------|
| <i>MT90 R390.11T3..</i> | | | <i>EURO</i> | |
| SM23871 | MT90 R390.11 D16 M08 L25 Z02-H | | 85 € | R390-11T3.. |
| SM23888 | MT90 R390.11 D20 M10 L30 Z03-H | | 90 € | |
| SM23895 | MT90 R390.11 D25 M12 L35 Z03-H | | 94 € | |
| SM23918 | MT90 R390.11 D32 M16 L43 Z04-H | | 102 € | |



| Ordering Code | Item Designation | | Price | Master Insert* |
|---|-----------------------------|---|-------------|----------------|
| <i>TK90 R390.11T3.. / R390.1704.. / R390.1806..</i> | | | <i>EURO</i> | |
| SM29156 | TK90 R390.11 D40 A16 Z05-H | | 72 € | R390-11T3.. |
| SM29149 | TK90 R390.11 D50 A22 Z06-H | | 89 € | |
| SM29132 | TK90 R390.11 D63 A22 Z07-H | | 103 € | |
| SM29125 | TK90 R390.17 D40 A16 Z04-H | | 68 € | R390-1704.. |
| SM29118 | TK90 R390.17 D50 A22 Z05-H | | 86 € | |
| SM29101 | TK90 R390.17 D63 A22 Z06-H | | 102 € | |
| SM29095 | TK90 R390.17 D80 A27 Z07-H | | 117 € | |
| SM29088 | TK90 R390.17 D100 A32 Z08-H | | 141 € | |
| SM14305 | TK90 R390.17 D125 B40 Z09 | - | 209 € | |
| SM50204 | TK90 R390.18 D50 A22 Z05-H | | 121 € | R390-1806.. |
| SM50211 | TK90 R390.18 D63 A22 Z06-H | | 132 € | |
| SM50228 | TK90 R390.18 D80 A27 Z07-H | | 149 € | |
| SM50235 | TK90 R390.18 D100 A32 Z08-H | | 158 € | |
| SM54097 | TK90 R390.18 D125 B40 Z09 | - | 237 € | |
| SM54103 | TK90 R390.18 D160 C40 Z12 | - | 350 € | |

| Size Designation | Master Insert* | Spare Parts | | | |
|------------------|----------------|------------------|-----------------|--------------------|-----|
| | | Screw | Torx Key | Screw Torque Value | |
| D10 - D16 | | | | | |
| D16 | R390-0702.. | SSV M1.8x4-9501 | STK-T06-9906 | 0,6 | |
| D20 - D32 | | R390-11T3.. | SSV M2.5x5-9504 | STK-T08-9908 | 1,2 |
| D40 - D63 | | | SSV M2.5x6-9505 | | |
| D25 - D30 | R390-1704.. | SSV M2.5x7-9506 | STK-T15-9910 | 2,9 | |
| D40 - D125 | | SSV M3.5x8-9510 | | | |
| D50 - D63 | | SSV M3.5x10-9511 | | | |
| D80 - D160 | R390-1806..** | SSV M4x9x5-9528 | | 3,0 | |

Milling Tools



| Ordering Code | Item Designation | | Price | Master Insert* |
|--------------------------------|------------------------------|---|-------------|----------------|
| <i>ST90 ASMT / ASGT 11T3..</i> | | | <i>EURO</i> | |
| SM53670 | ST90 AS11 D16 W16 L150 Z02-H | ✓ | 94 € | AS.T 11T3.. |
| SM53687 | ST90 AS11 D20 W20 L150 Z03-H | ✓ | 105 € | |
| SM53694 | ST90 AS11 D25 W25 L150 Z04-H | ✓ | 107 € | |
| SM53700 | ST90 AS11 D32 W32 L150 Z05-H | ✓ | 113 € | |



| Ordering Code | Item Designation | | Price | Master Insert* |
|--------------------------------|-----------------------------|---|-------------|----------------|
| <i>MT90 ASMT / ASGT 11T3..</i> | | | <i>EURO</i> | |
| SM53717 | MT90 AS11 D20 M10 L30 Z03-H | ✓ | 90 € | AS.T 11T3.. |
| SM53724 | MT90 AS11 D25 M12 L35 Z04-H | ✓ | 96 € | |
| SM53731 | MT90 AS11 D32 M16 L43 Z05-H | ✓ | 105 € | |



| Ordering Code | Item Designation | | Price | Master Insert* |
|--------------------------------|-------------------------|---|-------------|----------------|
| <i>TK90 ASMT / ASGT 11T3..</i> | | | <i>EURO</i> | |
| SM52918 | TK90 AS11 D40 A16 Z06-H | ✓ | 105 € | AS.T 11T3.. |
| SM52925 | TK90 AS11 D50 A22 Z07-H | ✓ | 132 € | |
| SM52932 | TK90 AS11 D63 A22 Z08-H | ✓ | 145 € | |

Cooling mounting screw is optional / See Page 294 for cooling mounting screws.
İçten su vermeli montaj vidaları opsiyoneldir. / Bkz. Sayfa 294 İçten su vermeli montaj vidaları için.



| Size Designation | Master Insert* | Spare Parts | | |
|------------------|----------------|--|--------------|--------------------|
| | | Screw | Torx Key | Screw Torque Value |
| D16 - D32 | AS.T 11T3..** | | | N-m |
| D40 - D63 | | SSV M2.5x6-9505 SSV M2.5x7-9506 | | |
| | | | STK-T08-9908 | 1,2 |

**Body corners should be modified for R2 and more radius inserts / R2 ve üstü radyüslü uçlarda takımın modifiye edilmesi gerekmektedir.

*Suitable Insert brand is TNGLY.



| Ordering Code | Item Designation | | Price | Master Insert* |
|---------------|--|---|-------|----------------|
| | <i>ST90 BDMT / BDGT 0703.. / 11T3.. / 1704..</i> | | EURO | |
| SM27701 | ST90 BD07 D10 C10 L100 Z01 | - | 101 € | BD..0703.. |
| SM27688 | ST90 BD07 D10 C10 L100 Z01-H | ✓ | 101 € | |
| SM27718 | ST90 BD07 D12 C12 L120 Z02 | - | 101 € | |
| SM27695 | ST90 BD07 D12 C12 L120 Z02-H | ✓ | 101 € | |
| SM54066 | ST90 BD11 D16 W16 L100 Z02-H | ✓ | 83 € | BD..11T3.. |
| SM37953 | ST90 BD11 D16 W16 L150 Z02 | - | 76 € | |
| SM29811 | ST90 BD11 D16 W16 L150 Z02-H | ✓ | 87 € | |
| SM27596 | ST90 BD11 D17 W16 L150 Z02-H | ✓ | 87 € | |
| SM27572 | ST90 BD11 D17 C16 L200 Z02 | - | 87 € | |
| SM54073 | ST90 BD11 D20 W20 L100 Z03-H | ✓ | 95 € | |
| SM37960 | ST90 BD11 D20 W20 L150 Z03 | - | 87 € | |
| SM29804 | ST90 BD11 D20 W20 L150 Z03-H | ✓ | 99 € | |
| SM27633 | ST90 BD11 D21 W20 L150 Z03-H | ✓ | 96 € | |
| SM27619 | ST90 BD11 D21 C20 L200 Z03 | - | 99 € | |
| SM54080 | ST90 BD11 D25 W25 L100 Z04-H | ✓ | 101 € | |
| SM37977 | ST90 BD11 D25 W25 L150 Z04 | - | 92 € | |
| SM29798 | ST90 BD11 D25 W25 L150 Z04-H | ✓ | 105 € | |
| SM27671 | ST90 BD11 D26 W25 L150 Z04-H | ✓ | 105 € | |
| SM27657 | ST90 BD11 D26 C25 L200 Z04 | - | 105 € | |
| SM37984 | ST90 BD11 D32 W32 L150 Z05-H | ✓ | 113 € | |
| SM35881 | ST90 BD17 D25 W25 L150 Z02 | - | 87 € | BD..1704.. |
| SM35898 | ST90 BD17 D25 W25 L150 Z02-H | ✓ | 96 € | |
| SM35911 | ST90 BD17 D25 C25 L200 Z02 | - | 101 € | |
| SM35904 | ST90 BD17 D32 W32 L150 Z03 | - | 96 € | |
| SM35928 | ST90 BD17 D32 C32 L200 Z03 | - | 119 € | |



Milling Tools

| Size Designation | Master Insert* | Spare Parts | | |
|------------------|----------------|--------------------|--------------|---------------------------|
| | | Screw | Torx Key | Screw Torque Value N-m |
| D10 - D12 | BD..0703.. | SSV M2x4-9521 | STK-T06-9906 | 0,6 |
| D16 - D17 | BD..11T3.. | SSV M2.5x5-9504 | STK-T08-9908 | 1,2 |
| D20 - D32 | | SSV M2.5x6-9505 | | |
| D25 - D32 | BD..1704.. | SSV M4x9x5-9528 | STK-T15-9910 | 3,0 |

*Suitable Insert brand is KYCR.



| Ordering Code | Item Designation | | Price | Master Insert* |
|--------------------------------|-----------------------------|---|-------|----------------|
| <i>MT90 BDMT / BDGT 11T3..</i> | | | EURO | |
| SM36543 | MT90 BD11 D16 M08 L25 Z02-H | ✓ | 85 € | BD..11T3.. |
| SM36550 | MT90 BD11 D20 M10 L30 Z03-H | ✓ | 88 € | |
| SM36567 | MT90 BD11 D25 M12 L35 Z04-H | ✓ | 94 € | |
| SM36574 | MT90 BD11 D32 M16 L43 Z05-H | ✓ | 102 € | |



| Ordering Code | Item Designation | | Price | Master Insert* |
|---|--------------------------|---|-------|----------------|
| <i>TK90 BDMT / BDGT 11T3.. / 1704..</i> | | | EURO | |
| SM52994 | TK90 BD11 D40 A16 Z04-H | ✓ | 72 € | BD..11T3.. |
| SM01767 | TK90 BD11 D40 A16 Z05-H | ✓ | 83 € | |
| SM53007 | TK90 BD11 D50 A22 Z04-H | ✓ | 88 € | |
| SM01774 | TK90 BD11 D50 A22 Z05-H | ✓ | 99 € | |
| SM01781 | TK90 BD11 D63 A22 Z06-H | ✓ | 114 € | |
| SM53014 | TK90 BD11 D80 A27 Z06-H | ✓ | 140 € | |
| SM01798 | TK90 BD11 D80 A27 Z07-H | ✓ | 165 € | |
| SM53021 | TK90 BD11 D100 A32 Z07-H | ✓ | 175 € | |
| SM39872 | TK90 BD17 D40 A16 Z04-H | ✓ | 72 € | BD..1704.. |
| SM31067 | TK90 BD17 D50 A22 Z05-H | ✓ | 86 € | |
| SM31074 | TK90 BD17 D63 A22 Z06-H | ✓ | 102 € | |
| SM31081 | TK90 BD17 D80 A27 Z07-H | ✓ | 117 € | |
| SM54059 | TK90 BD17 D100 A32 Z08-H | ✓ | 175 € | |

Cooling mounting screw is optional / See Page 294 for cooling mounting screws.
İçten su vermeli montaj vidaları opsiyoneldir. / Bkz. Sayfa 294 İçten su vermeli montaj vidaları için.

| Size Designation | Master Insert* | Spare Parts | | |
|------------------|----------------|--------------------|--------------|--------------------|
| | | Screw | Torx Key | Screw Torque Value |
| D16 | | | | N-m |
| D20 - D100 | | | | |
| D40 - D100 | BD..1704.. | SSV M4x9x5-9528 | STK-T15-9910 | 3,0 |

*Suitable Insert brand is KYCR.





| Ordering Code | Item Designation | | Price | Master Insert* |
|---------------|--------------------------------------|---|-------------|----------------|
| | ST90 AXMT 1235.. / 1705.. | | EURO | |
| SM26803 | ST90 AX12 D16 W16 L120 Z02 | - | 52 € | AXMT 1235.. |
| SM26810 | ST90 AX12 D16 W16 L150 Z02 | - | 56 € | |
| SM27220 | ST90 AX12 D16 C16 L200 Z02 | - | 63 € | |
| SM27817 | ST90 AX12 D20 W20 L110 Z03-H | ✓ | 59 € | |
| SM26902 | ST90 AX12 D20 W20 L120 Z03 | - | 59 € | |
| SM27824 | ST90 AX12 D20 W20 L120 Z03-H | ✓ | 69 € | |
| SM13100 | ST90 AX12 D20 W20 L150 Z03 | - | 63 € | |
| SM27800 | ST90 AX12 D20 W20 L150 Z03-H | ✓ | 73 € | |
| SM52130 | ST90 AX12 D20 C20 L200 Z03 | - | 69 € | |
| SM27848 | ST90 AX12 D25 C20 L120 Z04 | - | 67 € | |
| SM26827 | ST90 AX12 D25 W25 L120 Z04 | - | 63 € | |
| SM12745 | ST90 AX12 D25 W25 L150 Z03 | - | 84 € | |
| SM39025 | ST90 AX12 D25 W25 L150 Z04-H | ✓ | 95 € | |
| SM22225 | ST90 AX12 D25 C25 L200 Z04 | - | 101 € | |
| SM13117 | ST90 AX17 D25 W25 L150 Z02 | - | 80 € | |
| SM27077 | ST90 AX17 D32 W32 L120 Z03 | - | 87 € | |
| SM27060 | ST90 AX17 D32 W32 L120 Z03-H | ✓ | 101 € | |
| SM22249 | ST90 AX17 D32 W32 L150 Z03 | - | 84 € | |
| SM27084 | ST90 AX17 D32 C32 L200 Z03 | - | 101 € | |
| SM26797 | ST90 AX17 D32 C32 L250 Z03 | - | 123 € | |
| SM27022 | ST90 AX17 D40 W32 L150 Z04 | - | 95 € | |
| SM27039 | ST90 AX17 D40 C32 L200 Z04 | - | 116 € | |



Milling Tools

| Size Designation | Master Insert* | Spare Parts | | |
|------------------|----------------|---------------------|--------------|--------------------|
| | | Screw | Torx Key | Screw Torque Value |
| | | | | |
| D16 - D25 | AXMT 1235..** | SSV M3x6 LG-9509 | STK-T08-9908 | 1,9 |
| D25 - D40 | AXMT 1705..** | SSV M4x10-9514 | STK-T15-9910 | 4,3 |

** Body corners should be modified for R2 and more radius inserts / R2 ve üstü radyüslü uçlarda takımın modifiye edilmesi gerekmektedir.

* Suitable Insert brand is SMTM.



| Ordering Code | Item Designation | | Price | Master Insert* |
|---------------|--|---|-------------|----------------|
| | MT90 AXMT 1235.. / 1705.. | | EURO | |
| SM23994 | MT90 AX12 D16 M08 L25 Z02-H | ✓ | 85 € | AXMT 1235.. |
| SM24007 | MT90 AX12 D20 M10 L30 Z03-H | ✓ | 88 € | |
| SM24014 | MT90 AX12 D25 M12 L35 Z04-H | ✓ | 94 € | |
| SM56466 | MT90 AX17 D32 M16 L43 Z03-H | ✓ | 110 € | AXMT 1705.. |
| SM56473 | MT90 AX17 D40 M16 L43 Z04-H | ✓ | 119 € | |



| Ordering Code | Item Designation | | Price | Master Insert* |
|---------------|--|---|-------------|----------------|
| | TK90 AXMT 1235.. / 1705.. | | EURO | |
| SM28395 | TK90 AX12 D40 A16 Z05-H | ✓ | 69 € | AXMT 1235.. |
| SM28388 | TK90 AX12 D50 A22 Z06-H | ✓ | 87 € | |
| SM28371 | TK90 AX12 D63 A22 Z07-H | ✓ | 105 € | |
| SM28364 | TK90 AX12 D80 A27 Z09-H | ✓ | 119 € | |
| SM28357 | TK90 AX17 D40 A16 Z04-H | ✓ | 69 € | AXMT 1705.. |
| SM28340 | TK90 AX17 D50 A22 Z05-H | ✓ | 87 € | |
| SM28333 | TK90 AX17 D63 A22 Z06-H | ✓ | 105 € | |
| SM24373 | TK90 AX17 D80 A27 Z07-H | ✓ | 119 € | |
| SM24380 | TK90 AX17 D100 A32 Z08-H | ✓ | 143 € | |

Cooling mounting screw is optional / See Page 294 for cooling mounting screws.
İçten su vermeli montaj vidaları opsiyoneldir. / Bkz. Sayfa 294 İçten su vermeli montaj vidaları için.



| Size Designation | Master Insert* | Spare Parts | | |
|------------------|----------------|-------------------------|------------------|--------------------|
| | | Screw | Torx Key | Screw Torque Value |
| D16 - D80 | AXMT 1235..** | SSV M3x6 LG-9509 | STK-T08-9908 | N-m 1,9 |
| D32 - D100 | AXMT 1705..** | SSV M4x10-9514 | STK-T15-9910 | N-m 4,3 |

**Body corners should be modified for R2 and more radius inserts / R2 ve üstü radyüslü uçlarda takımın modifiye edilmesi gerekmektedir.

*Suitable Insert brand is SMTM.



| Ordering Code | Item Designation | | Price | Master Insert* |
|---------------|---|---|-------|----------------|
| | ST90 ADMX 0702.. / 11T3.. / 1606.. | | EURO | |
| SM44197 | ST90 ADMX07 D10 C10 L120 Z02-H | ✓ | 85 € | ADMX 0702.. |
| SM44203 | ST90 ADMX07 D12 C12 L120 Z03-H | ✓ | 85 € | |
| SM43770 | ST90 ADMX11 D20 W20 L150 Z02-H | ✓ | 97 € | ADMX 11T3.. |
| SM43787 | ST90 ADMX11 D25 W25 L150 Z03-H | ✓ | 112 € | |
| SM43794 | ST90 ADMX11 D32 W32 L150 Z04-H | ✓ | 122 € | |
| SM43800 | ST90 ADMX16 D25 W25 L150 Z02-H | ✓ | 112 € | ADMX 1606.. |
| SM43817 | ST90 ADMX16 D32 W32 L150 Z03-H | ✓ | 122 € | |



| Ordering Code | Item Designation | | Price | Master Insert* |
|---------------|--|---|-------|----------------|
| | TK90 ADMX 11T3.. / 1606.. | | EURO | |
| SM43527 | TK90 ADMX11 D40 A16 Z05-H | ✓ | 101 € | ADMX 11T3.. |
| SM43534 | TK90 ADMX11 D50 A22 Z06-H | ✓ | 119 € | |
| SM43541 | TK90 ADMX11 D63 A22 Z07-H | ✓ | 132 € | |
| SM42902 | TK90 ADMX16 D50 A22 Z05-H | ✓ | 101 € | ADMX 1606.. |
| SM42919 | TK90 ADMX16 D63 A22 Z06-H | ✓ | 121 € | |
| SM42926 | TK90 ADMX16 D80 A27 Z07-H | ✓ | 132 € | |

Cooling mounting screw is optional / See Page 294 for cooling mounting screws.
İçten su vermeli montaj vidaları opsiyoneldir. / Bkz. Sayfa 294 İçten su vermeli montaj vidaları için.



| Size Designation | Master Insert* | Spare Parts | | |
|------------------|----------------|---------------------|--------------|---------------------------|
| | | Screw | Torx Key | Screw Torque Value N·m |
| D10 - D12 | ADMX 0702.. | SSV M2x5-9502 | STK-T06-9906 | 0,6 |
| D20 | ADMX 11T3.. | SSV M2.5x6-9505 | STK-T08-9908 | 1,2 |
| D25 - D63 | | SSV M2.5x7 -9506 | | |
| D50 - D80 | ADMX 1606.. | SSV M4x10-9514 | STK-T15-9910 | 4,3 |



| Ordering Code | Item Designation | | Price | Master Insert* |
|---------------|------------------------------|---|-------|----------------|
| | ST90 ADKT 1505.. | | EURO | |
| SM12110 | ST90 AD1505 D25 W25 L120 Z02 | - | 68 € | ADKT 1505.. |
| SM12134 | ST90 AD1505 D25 W25 L150 Z02 | - | 81 € | |
| SM26704 | ST90 AD1505 D30 W25 L150 Z03 | - | 83 € | |
| SM12127 | ST90 AD1505 D32 W32 L120 Z03 | - | 73 € | |
| SM12141 | ST90 AD1505 D32 W32 L150 Z03 | - | 83 € | |



| Ordering Code | Item Designation | | Price | Master Insert* |
|---------------|-------------------------------|---|-------|----------------|
| | MT90 ADKT 1505.. | | EURO | |
| SM56442 | MT90 AD1505 D25 M12 L35 Z02-H | ✓ | 110 € | ADKT 1505.. |
| SM56459 | MT90 AD1505 D32 M16 L43 Z03-H | ✓ | 120 € | |



| Ordering Code | Item Designation | | Price | Master Insert* |
|---------------|----------------------------|---|-------|----------------|
| | TK90 ADKT 1505.. | | EURO | |
| SM29200 | TK90 AD1505 D40 A16 Z04-H | ✓ | 68 € | ADKT 1505.. |
| SM29194 | TK90 AD1505 D50 A22 Z05-H | ✓ | 86 € | |
| SM29187 | TK90 AD1505 D63 A22 Z06-H | ✓ | 102 € | |
| SM29170 | TK90 AD1505 D80 A27 Z07-H | ✓ | 117 € | |
| SM29163 | TK90 AD1505 D100 A32 Z08-H | ✓ | 141 € | |
| SM13933 | TK90 AD1505 D125 B40 Z09 | - | 209 € | |

Cooling mounting screw is optional / See Page 294 for cooling mounting screws.
İçten su vermeli montaj vidaları opsiyoneldir. / Bkz. Sayfa 294 İçten su vermeli montaj vidaları için.

| Size Designation | Master Insert* | Spare Parts | | |
|------------------|----------------|-----------------------|------------------|--------------------|
| | | Screw | Torx Key | Screw Torque Value |
| D25 - D125 | | SSV M4x10-9514 | STK-T15-9910 | N-m 4,3 |

**Body corners should be modified for R2 and more radius inserts / R2 ve üstü radyüslü uçlarda takımın modifiye edilmesi gerekmektedir.

*Suitable Insert brand is ISC.



| Ordering Code | Item Designation | | Price | Master Insert* |
|---------------|--|---|-------|----------------|
| | ST90 AD.T 0803.. / 10T3.. / 1204.. | | EURO | |
| SM35300 | ST90 AD08 D16 W16 L150 Z02-H | ✓ | 76 € | ADMT 0803.. |
| SM35331 | ST90 AD08 D16 C16 L200 Z02 | - | 91 € | |
| SM35317 | ST90 AD08 D20 W20 L150 Z03-H | ✓ | 91 € | |
| SM35348 | ST90 AD08 D20 C20 L200 Z03 | - | 109 € | |
| SM35324 | ST90 AD08 D25 W25 L150 Z04-H | ✓ | 105 € | ADMT 10T3.. |
| SM35355 | ST90 AD10 D16 W16 L150 Z02-H | ✓ | 87 € | |
| SM35362 | ST90 AD10 D20 W20 L150 Z03-H | ✓ | 95 € | |
| SM35379 | ST90 AD10 D25 W25 L150 Z04-H | ✓ | 98 € | ADKT 1204.. |
| SM35386 | ST90 AD12 D20 W20 L150 Z02 | - | 91 € | |
| SM35393 | ST90 AD12 D25 W25 L150 Z03 | - | 98 € | |
| SM00531 | ST90 AD12 D25 W25 L150 Z03-H | - | 98 € | |
| SM35409 | ST90 AD12 D30 W25 L150 Z04 | ✓ | 108 € | |
| SM35416 | ST90 AD12 D32 W32 L150 Z04 | - | 112 € | |



| Ordering Code | Item Designation | | Price | Master Insert* |
|---------------|--|---|-------|----------------|
| | MT90 AD.T 0803.. / 10T3.. / 1204.. WLTR | | EURO | |
| SM56350 | MT90 AD08 D16 M08 L25 Z02-H | ✓ | 90 € | ADMT 0803.. |
| SM56367 | MT90 AD08 D20 M10 L30 Z03-H | ✓ | 92 € | |
| SM56374 | MT90 AD08 D25 M12 L35 Z04-H | ✓ | 95 € | |
| SM56381 | MT90 AD10T3 D16 M08 L25 Z02-H | ✓ | 90 € | ADMT 10T3.. |
| SM56398 | MT90 AD10T3 D20 M10 L30 Z03-H | ✓ | 92 € | |
| SM56404 | MT90 AD10T3 D25 M12 L35 Z04-H | ✓ | 97 € | |
| SM56411 | MT90 AD12 D20 M10 L30 Z02-H | ✓ | 92 € | ADKT 1204.. |
| SM56428 | MT90 AD12 D25 M12 L35 Z03-H | ✓ | 97 € | |
| SM56435 | MT90 AD12 D32 M16 L43 Z04-H | ✓ | 107 € | |



| Ordering Code | Item Designation | | Price | Master Insert* |
|---------------|--|---|-------|----------------|
| | TK90 AD.T 10T3.. / 1204.. / 1606.. | | EURO | |
| SM31340 | TK90 AD10T3 D40 A16 Z05-H | ✓ | 72 € | ADMT 10T3.. |
| SM31234 | TK90 AD10T3 D50 A22 Z06-H | ✓ | 87 € | |
| SM31258 | TK90 AD10T3 D63 A22 Z07-H | ✓ | 105 € | |
| SM54271 | TK90 AD12 D40 A16 Z05-H | ✓ | 105 € | ADKT 1204.. |
| SM54288 | TK90 AD12 D50 A22 Z06-H | ✓ | 120 € | |
| SM54295 | TK90 AD12 D63 A22 Z07-H | ✓ | 130 € | |
| SM54301 | TK90 AD12 D80 A27 Z08-H | ✓ | 145 € | |
| SM31296 | TK90 AD1606 D50 A22 Z05-H | ✓ | 85 € | ADMT 1606.. |
| SM31319 | TK90 AD1606 D63 A22 Z06-H | ✓ | 105 € | |
| SM31333 | TK90 AD1606 D80 A27 Z07-H | ✓ | 118 € | |

| Size Designation | Master Insert* | Spare Parts | | |
|------------------|----------------|------------------|--------------|--------------------|
| | | Screw | Torx Key | Screw Torque Value |
| D16 - D20 | ADMT 0803..** | SSV M2.5x5-9504 | STK-T08-9908 | 1,2 |
| D25 | | SSV M2.5x6-9505 | | |
| D16 - D25 | ADMT 10T3..** | SSV M2.5x6-9505 | | |
| D40 - D63 | | SSV M2.5x7-9506 | | |
| D20 - D25 | ADKT 1204..** | SSV M3x6-9507 | 1,9 | |
| D30 - D63 | | SSV M3x8-9508 | | |
| D50 - D80 | ADMT 1606..** | SSV M3.5x10-9511 | STK-T15-9910 | 2,9 |

** Body corners should be modified for R2 and more radius inserts / R2 ve üstü radyüslü uçlarda takımın modifiye edilmesi gerekmektedir.

* Suitable Insert brand is WLTR.



| Ordering Code | Item Designation | | Price | Master Insert* |
|---------------|---|---|-------|----------------|
| | ST90 EDPT 10T3.. /1404.. | | EURO | |
| SM43220 | ST90 ED10 D16 W16 L150 Z02-H | ✓ | 94 € | EDPT 10T3.. |
| SM43237 | ST90 ED10 D20 W20 L150 Z03-H | ✓ | 97 € | |
| SM43244 | ST90 ED10 D25 W25 L150 Z04-H | ✓ | 112 € | |
| SM49680 | ST90 ED10 D32 W32 L150 Z05-H | ✓ | 122 € | |
| SM43268 | ST90 ED14 D20 W20 L150 Z02-H | ✓ | 97 € | EDPT 1404.. |
| SM43275 | ST90 ED14 D25 W25 L150 Z03-H | ✓ | 112 € | |
| SM43282 | ST90 ED14 D32 W32 L150 Z04-H | ✓ | 122 € | |
| SM43299 | ST90 ED14 D40 W32 L150 Z05-H | ✓ | 141 € | |



| Ordering Code | Item Designation | | Price | Master Insert* |
|---------------|---|---|-------|----------------|
| | MT90 EDPT 10T3.. /1404.. | | EURO | |
| SM43848 | MT90 ED10 D16 M08 L25 Z02-H | ✓ | 85 € | EDPT 10T3.. |
| SM43855 | MT90 ED10 D20 M10 L30 Z03-H | ✓ | 88 € | |
| SM43862 | MT90 ED10 D25 M12 L35 Z04-H | ✓ | 94 € | |
| SM56558 | MT90 ED10 D32 M16 L43 Z05-H | ✓ | 99 € | |
| SM43879 | MT90 ED14 D20 M10 L30 Z02-H | ✓ | 85 € | EDPT 1404.. |
| SM43886 | MT90 ED14 D25 M12 L35 Z03-H | ✓ | 94 € | |
| SM43893 | MT90 ED14 D32 M16 L43 Z04-H | ✓ | 102 € | |



| Ordering Code | Item Designation | | Price | Master Insert* |
|---------------|---|---|-------|----------------|
| | TK90 EDPT 10T3.. /1404.. | | EURO | |
| SM42995 | TK90 ED10 D40 A16 Z05-H | ✓ | 101 € | EDPT 10T3.. |
| SM43008 | TK90 ED10 D50 A22 Z06-H | ✓ | 119 € | |
| SM43015 | TK90 ED10 D63 A22 Z07-H | ✓ | 132 € | |
| SM43022 | TK90 ED14 D40 A16 Z04-H | ✓ | 101 € | EDPT 1404.. |
| SM43039 | TK90 ED14 D50 A22 Z05-H | ✓ | 119 € | |
| SM43046 | TK90 ED14 D63 A22 Z06-H | ✓ | 132 € | |
| SM43053 | TK90 ED14 D80 A27 Z07-H | ✓ | 150 € | |

Cooling mounting screw is optional / See Page 294 for cooling mounting screws.
İçten su vermeli montaj vidaları opsiyoneldir. / Bkz. Sayfa 294 İçten su vermeli montaj vidaları için.



Milling Tools

| Size Designation | Master Insert* | Spare Parts | | |
|------------------|----------------|-------------|--------------|--------------------|
| | | Screw | Torx Key | Screw Torque Value |
| D16 - D20 | EDPT 10T3..** | | | 1,2 |
| D25 - D32 | | | | |
| D20 | EDPT 1404..** | | STK-T08-9908 | 1,9 |
| D25 - D80 | | | | |

**Body corners should be modified for R2 and more radius inserts / R2 ve üstü radyüslü uçlarda takımın modifiye edilmesi gerekmektedir.

*Suitable Insert brand is KNMTL.



| Ordering Code | Item Designation | | Price | Master Insert* |
|---------------|---|---|-------------|----------------|
| | ST90 RT 0702../1003../1606.. | | EURO | |
| SM13452 | ST90 RT07 D10 C10 L120 Z02 | - | 72 € | RT 0703.. |
| SM13445 | ST90 RT07 D12 C12 L120 Z02 | - | 72 € | |
| SM13469 | ST90 RT07 D12 W12 L120 Z02 | - | 72 € | |
| SM13476 | ST90 RT07 D14 W12 L120 Z02 | - | 73 € | |
| SM13490 | ST90 RT10 D16 W16 L120 Z02 | - | 69 € | RT 1003.. |
| SM13537 | ST90 RT10 D16 W16 L150 Z02 | - | 83 € | |
| SM13599 | ST90 RT10 D16 C16 L200 Z02 | - | 97 € | |
| SM13544 | ST90 RT10 D17 W16 L150 Z02 | - | 88 € | |
| SM13506 | ST90 RT10 D18 W16 L120 Z02 | - | 80 € | |
| SM13513 | ST90 RT10 D20 W20 L120 Z03 | - | 83 € | |
| SM13551 | ST90 RT10 D20 W20 L150 Z03 | - | 96 € | |
| SM13483 | ST90 RT10 D20 C20 L200 Z03 | - | 101 € | |
| SM13568 | ST90 RT10 D22 W20 L120 Z03 | - | 83 € | |
| SM13575 | ST90 RT10 D22 W20 L150 Z03 | - | 96 € | |
| SM13612 | ST90 RT10 D22 C20 L200 Z03 | - | 101 € | |
| SM13520 | ST90 RT10 D25 W25 L120 Z04 | - | 84 € | |
| SM26896 | ST90 RT10 D25 W25 L150 Z04 | - | 100 € | |
| SM13636 | ST90 RT10 D25 C25 L200 Z04 | - | 108 € | |
| SM13582 | ST90 RT10 D32 W32 L120 Z05 | - | 91 € | |
| SM13629 | ST90 RT10 D32 W32 L150 Z05 | - | 107 € | |
| SM13643 | ST90 RT10 D32 C32 L200 Z05 | - | 132 € | |
| SM13650 | ST90 RT16 D25 W25 L120 Z02 | - | 83 € | RT 1606.. |
| SM13674 | ST90 RT16 D25 W25 L150 Z02 | - | 92 € | |
| SM13698 | ST90 RT16 D25 C25 L200 Z02 | - | 129 € | |
| SM13667 | ST90 RT16 D32 W32 L120 Z03 | - | 97 € | |
| SM13681 | ST90 RT16 D32 W32 L150 Z03 | - | 108 € | |
| SM13735 | ST90 RT16 D32 C32 L200 Z03 | - | 111 € | |
| SM13711 | ST90 RT16 D32 C32 L250 Z03 | - | 145 € | |
| SM13704 | ST90 RT16 D40 W32 L120 Z04 | - | 108 € | |
| SM13728 | ST90 RT16 D40 W32 L150 Z04 | - | 128 € | |
| SM13742 | ST90 RT16 D40 C32 L200 Z04 | - | 132 € | |



Milling Tools

| Size Designation | Master Insert* | Spare Parts | | |
|------------------|----------------|------------------------|------------------|--------------------|
| | | Screw | Torx Key | Screw Torque Value |
| D10 - D14 | RT 0703.. | SSV M2x5-9502 | STK-T06-9906 | 0,6 |
| D16 - D18 | | | | |
| D20 - D32 | RT 1003.. | SSV M2.5x6-9505 | STK-T08-9908 | 1,2 |
| D25 - D40 | | | | |
| | RT 1606.. | SSV M4x10-9514 | STK-T15-9910 | 4,3 |



| Ordering Code | Item Designation | | Price | Master Insert* |
|---------------|-----------------------------|---|-------|----------------|
| | MT90 RT 1003.. | | EURO | |
| SM24069 | MT90 RT10 D25 M12 L35 Z04-H | ✓ | 94 € | RT 1003.. |
| SM24076 | MT90 RT10 D32 M16 L43 Z05-H | ✓ | 102 € | |
| SM24083 | MT90 RT10 D42 M16 L43 Z06-H | ✓ | 111 € | |



| Ordering Code | Item Designation | | Price | Master Insert* |
|---------------|------------------------------|---|-------|----------------|
| | TK90 RT 1003../1606.. | | EURO | |
| SM28258 | TK90 RT10 D40 A16 Z06-H | ✓ | 69 € | RT 1003.. |
| SM28241 | TK90 RT10 D50 A22 Z07-H | ✓ | 87 € | |
| SM28234 | TK90 RT10 D63 A22 Z09-H | ✓ | 105 € | |
| SM28227 | TK90 RT16 D50 A22 Z05-H | ✓ | 84 € | RT 1606.. |
| SM28210 | TK90 RT16 D63 A22 Z06-H | ✓ | 95 € | |
| SM24311 | TK90 RT16 D80 A27 Z07-H | ✓ | 116 € | |
| SM24328 | TK90 RT16 D100 A32 Z08-H | ✓ | 153 € | |

Cooling mounting screw is optional / See Page 294 for cooling mounting screws.
İçten su vermeli montaj vidaları opsiyoneldir. / Bkz. Sayfa 294 İçten su vermeli montaj vidaları için.



| Size Designation | Master Insert* | Spare Parts | | |
|------------------|----------------|------------------------|------------------|--------------------|
| | | Screw | Torx Key | Screw Torque Value |
| D25 - D32 | | SSV M2.5x6-9505 | STK-T08-9908 | 1,2 |
| D40 - D63 | | SSV M2.5x7-9506 | | |
| D50 - D100 | RT 1606.. | SSV M4x10-9514 | STK-T15-9910 | 4,3 |



| Ordering Code | Item Designation | | Price | Master Insert* |
|---------------|---|---|-------------|----------------|
| | <i>ST90 XOMX 0602.. / 10T3.. / 1204..</i> | | <i>EURO</i> | |
| SM35485 | ST90 XO06 D10 C10 L120 Z02 | - | 82 € | XOMX 0602.. |
| SM35492 | ST90 XO06 D12 C12 L120 Z03 | - | 82 € | |
| SM49734 | ST90 XO06 D16 W16 L120 Z03-H | ✓ | 93 € | |
| SM43176 | ST90 XO06 D20 W20 L120 Z04-H | ✓ | 97 € | |
| SM37892 | ST90 XO10 D16 W16 L120 Z02 | - | 57 € | XOMX 10T3.. |
| SM35508 | ST90 XO10 D16 W16 L120 Z02-H | ✓ | 71 € | |
| SM35522 | ST90 XO10 D16 W16 L150 Z02-H | ✓ | 85 € | |
| SM37908 | ST90 XO10 D20 W20 L120 Z03 | - | 74 € | |
| SM35515 | ST90 XO10 D20 W20 L120 Z03-H | ✓ | 88 € | |
| SM35539 | ST90 XO10 D20 W20 L150 Z03-H | ✓ | 88 € | |
| SM35546 | ST90 XO10 D20 C20 L200 Z03 | - | 94 € | |
| SM35553 | ST90 XO12 D20 W20 L120 Z02-H | ✓ | 74 € | XOMX 1204.. |
| SM35560 | ST90 XO12 D20 W20 L150 Z02-H | ✓ | 88 € | |
| SM35584 | ST90 XO12 D20 C20 L200 Z02 | - | 94 € | |
| SM35577 | ST90 XO12 D25 W25 L150 Z03-H | ✓ | 103 € | |
| SM35591 | ST90 XO12 D25 C25 L200 Z03 | - | 103 € | |
| SM26483 | ST90 XO12 D32 W32 L150 Z04-H | ✓ | 106 € | |
| SM35607 | ST90 XO12 D32 C32 L200 Z04 | - | 121 € | |





| Ordering Code | Item Designation | | Price | Master Insert* |
|---------------|--|---|-------|----------------|
| | MT90 XOMX 10T3../1204.. SCO | | EURO | |
| SM36581 | MT90 XO10 D16 M08 L25 Z02-H | ✓ | 86 € | XOMX 10T3.. |
| SM36598 | MT90 XO10 D20 M10 L30 Z03-H | ✓ | 90 € | |
| SM36604 | MT90 XO12 D20 M10 L30 Z02-H | ✓ | 90 € | XOMX 1204.. |
| SM36611 | MT90 XO12 D25 M12 L35 Z03-H | ✓ | 95 € | |
| SM36628 | MT90 XO12 D32 M16 L43 Z04-H | ✓ | 104 € | |



| Ordering Code | Item Designation | | Price | Master Insert* |
|---------------|---|---|-------|----------------|
| | ST90 XOMX 0602../10T3../1204.. | | EURO | |
| SM53847 | TK90 XO10 D40 A16 Z05-H | ✓ | 77 € | XOMX 10T3.. |
| SM53854 | TK90 XO10 D40 A16 Z06-H | ✓ | 86 € | |
| SM53861 | TK90 XO10 D50 A22 Z06-H | ✓ | 94 € | |
| SM53878 | TK90 XO10 D50 A22 Z07-H | ✓ | 103 € | |
| SM53885 | TK90 XO10 D63 A22 Z07-H | ✓ | 115 € | |
| SM53892 | TK90 XO10 D63 A22 Z08-H | ✓ | 129 € | |
| SM53908 | TK90 XO12 D40 A16 Z04-H | ✓ | 73 € | XOMX 1204.. |
| SM28944 | TK90 XO12 D40 A16 Z05-H | ✓ | 77 € | |
| SM53915 | TK90 XO12 D50 A22 Z05-H | ✓ | 90 € | |
| SM27237 | TK90 XO12 D50 A22 Z06-H | ✓ | 94 € | |
| SM53922 | TK90 XO12 D63 A22 Z07-H | ✓ | 111 € | |
| SM28937 | TK90 XO12 D63 A22 Z08-H | ✓ | 115 € | |
| SM53939 | TK90 XO12 D80 A27 Z08-H | ✓ | 129 € | |
| SM28920 | TK90 XO12 D80 A27 Z09-H | ✓ | 133 € | |
| SM38196 | TK90 XO12 D100 A32 Z11-H | ✓ | 195 € | |
| SM38202 | TK90 XO12 D125 B40 Z12 | - | 230 € | |
| SM31012 | TK90 XO18 D50 A22 Z04-H | ✓ | 88 € | XOMX 1806.. |
| SM31029 | TK90 XO18 D63 A22 Z05-H | ✓ | 118 € | |
| SM31036 | TK90 XO18 D80 A27 Z07-H | ✓ | 125 € | |
| SM31043 | TK90 XO18 D100 A32 Z08-H | ✓ | 146 € | |
| SM31050 | TK90 XO18 D125 B40 Z10 | - | 196 € | |

Cooling mounting screw is optional / See Page 294 for cooling mounting screws.
İçten su vermeli montaj vidaları opsiyoneldir. / Bkz. Sayfa 294 İçten su vermeli montaj vidaları için.

| Size Designation | Master Insert* | Spare Parts | | |
|------------------|----------------|-----------------------|--------------|------------------------|
| | | Screw | Torx Key | Screw Torque Value |
| D10 - D20 | XOMX 0602..** | SSV M1.8X4-9501 | STK-T06-9906 | 0,6 |
| D16 | XOMX 10T3..** | SSV M2.5x5-9504 | STK-T08-9908 | 1,2 |
| D20 - D63 | | SSV M2.5x7-9506 | | |
| D20 - D125 | XOMX 1204..** | SSV M3.5x8 SC-9513 | STK-T10-9909 | 2,9 |
| D50 - D125 | XOMX 1806..** | SSV M4.5x11-9518 | STK-T20-9911 | 5,0 |

**Body corners should be modified for R2 and more radius inserts / R2 ve üstü radyüslü uçlarda takımın modifiye edilmesi gerekmektedir.

*Suitable Insert brand is SCO.



| Ordering Code | Item Designation | | Price | Master Insert* |
|---------------|------------------------------|---|-------|----------------|
| | ST90 AOMT 1236.. | | EURO | |
| SM35614 | ST90 AO12 D16 W16 L150 Z02-H | ✓ | 88 € | AOMT 1236.. |
| SM35621 | ST90 AO12 D20 W20 L150 Z03-H | ✓ | 96 € | |
| SM35638 | ST90 AO12 D22 W20 L150 Z03-H | ✓ | 96 € | |
| SM35645 | ST90 AO12 D25 W25 L150 Z04-H | ✓ | 100 € | |
| SM35652 | ST90 AO12 D32 W32 L150 Z05-H | ✓ | 106 € | |



| Ordering Code | Item Designation | | Price | Master Insert* |
|---------------|-----------------------------|---|-------|----------------|
| | MT90 AOMT 1236.. | | EURO | |
| SM54981 | MT90 AO12 D16 M08 L25 Z02-H | ✓ | 86 € | AOMT 1236.. |
| SM54998 | MT90 AO12 D20 M10 L30 Z03-H | ✓ | 90 € | |
| SM55001 | MT90 AO12 D25 M12 L35 Z04-H | ✓ | 101 € | |
| SM55018 | MT90 AO12 D32 M16 L43 Z05-H | ✓ | 109 € | |



| Ordering Code | Item Designation | | Price | Master Insert* |
|---------------|--------------------------|---|-------|----------------|
| | TK90 AOMT 1236.. | | EURO | |
| SM30961 | TK90 AO12 D40 A16 Z05-H | ✓ | 103 € | AOMT 1236.. |
| SM30978 | TK90 AO12 D50 A22 Z06-H | ✓ | 121 € | |
| SM30985 | TK90 AO12 D63 A22 Z07-H | ✓ | 134 € | |
| SM30992 | TK90 AO12 D80 A27 Z08-H | ✓ | 152 € | |
| SM31005 | TK90 AO12 D100 A32 Z10-H | ✓ | 177 € | |

Cooling mounting screw is optional / See Page 294 for cooling mounting screws.
İçten su vermeli montaj vidaları opsiyoneldir. / Bkz. Sayfa 294 İçten su vermeli montaj vidaları için.

| Size Designation | Master Insert* | Spare Parts | | |
|------------------|----------------|--|----------|--------------------|
| | | Screw | Torx Key | Screw Torque Value |
| D16 - D20 | AOMT 1236.. | | | N·m |
| D22 - D100 | | SSV M2.5x5-9504 SSV M2.5x6-9505 | | |



*Suitable Insert brand is MTSBH.



| Ordering Code | Item Designation | | Price | Master Insert* |
|---------------|------------------------------|---|-------|----------------|
| | ST90 AOMT 0702.. | | EURO | |
| SM46306 | ST90 AO07 D12 W12 L120 Z02-H | ✓ | 86 € | AOMT 0702.. |
| SM46313 | ST90 AO07 D16 W16 L120 Z03-H | ✓ | 95 € | |
| SM46320 | ST90 AO07 D20 W20 L150 Z04-H | ✓ | 99 € | |
| SM46337 | ST90 AO07 D22 W20 L150 Z04-H | ✓ | 106 € | |



| Size Designation | Master Insert* | Spare Parts | | |
|------------------|----------------|-----------------|--------------|--------------------|
| | | Screw | Torx Key | Screw Torque Value |
| D12 - D22 | AOMT 0702.. | | | N·m |
| | | SSV M2.2x5-9503 | STK-T06-9906 | 0,85 |

*Suitable Insert brand is TNGLY.

| | Ordering Code | Item Designation | | Price | Master Insert* |
|---------|---|------------------------------|----------------------------------|---|----------------|
| |  | | ST90 XDKT 0703.. / 11T3.. |  | EURO |
| SM29781 | | ST90 XD07 D12 C10 L120 Z02 | - | 82 € | XDKT 0703.. |
| SM29774 | | ST90 XD07 D12 C12 L120 Z02 | - | 82 € | |
| SM37922 | | ST90 XD07 D16 W16 L150 Z03-H | ✓ | 85 € | |
| SM29750 | | ST90 XD07 D16 C16 L200 Z03 | - | 82 € | |
| SM37915 | | ST90 XD07 D17 W16 L150 Z03-H | ✓ | 85 € | |
| SM29743 | | ST90 XD11 D16 W16 L150 Z02-H | ✓ | 88 € | XDKT 11T3.. |
| SM29736 | | ST90 XD11 D16 C16 L200 Z02 | - | 82 € | |
| SM29712 | | ST90 XD11 D17 W16 L150 Z02-H | ✓ | 88 € | |
| SM29729 | | ST90 XD11 D17 C16 L200 Z02 | - | 82 € | |
| SM29590 | | ST90 XD11 D20 W20 L150 Z03-H | ✓ | 93 € | |
| SM29613 | | ST90 XD11 D20 C20 L200 Z03 | - | 94 € | |
| SM29583 | | ST90 XD11 D21 W20 L150 Z03-H | ✓ | 93 € | |
| SM29606 | | ST90 XD11 D21 C20 L200 Z03 | - | 94 € | |
| SM29620 | | ST90 XD11 D25 W25 L150 Z03-H | ✓ | 96 € | |
| SM29576 | | ST90 XD11 D25 C25 L200 Z03 | - | 103 € | |
| SM29705 | | ST90 XD11 D26 W25 L150 Z04-H | ✓ | 96 € | |
| SM29699 | | ST90 XD11 D26 C25 L200 Z04 | - | 103 € | |



| Size Designation | Master Insert* | Spare Parts | | |
|------------------|--|--|---|---|
| |  | Screw | Torx Key | Screw Torque Value |
| D12 - D16 | XDKT 0703.. |  SSV M2.2x5-9503 |  STK-T06-9906 |  0,85 |
| D16 - D17 | XDKT 11T3.. | SSV M2.5x5-9504 | STK-T08-9908 | 1,2 |
| D20 - D26 | | SSV M2.5x6-9505 | | |

*Suitable Insert brand is CRTZ.

| | Ordering Code | Item Designation | | Price | Master Insert* |
|---------|---|--------------------------------|-------------------------|---|----------------|
| |  | | ST90 APKT 0602.. |  | EURO |
| SM43374 | | ST90 APKT06 D10 W10 L120 Z02-H | ✓ | 83 € | APKT 0602.. |
| SM43381 | | ST90 APKT06 D11 W10 L120 Z02-H | ✓ | 83 € | |
| SM43398 | | ST90 APKT06 D12 W12 L120 Z03-H | ✓ | 83 € | |
| SM43404 | | ST90 APKT06 D13 W12 L120 Z03-H | ✓ | 83 € | |

| | | | | |
|-----------|--------------|-----------------|--------------|-----|
| D10 - D16 | APKT 0602..* | SSV M1.8x4-9501 | STK-T06-9906 | 0,6 |
|-----------|--------------|-----------------|--------------|-----|

*Suitable Insert brand is LMN.

| | Ordering Code | Item Designation | | Price | Master Insert* |
|---------|---|------------------------------|-------------------------|---|----------------|
| |  | | ST90 AXMT 0602.. |  | EURO |
| SM43138 | | ST90 AX06 D10 W10 L120 Z02-H | ✓ | 86 € | AXMT 0602..* |
| SM43145 | | ST90 AX06 D12 W12 L120 Z02-H | ✓ | 86 € | |
| SM43152 | | ST90 AX06 D16 W16 L120 Z04-H | ✓ | 95 € | |

| Size Designation | Master Insert* | Spare Parts | | |
|------------------|---|---|--|---|
| |  | Screw | Torx Key | Screw Torque Value |
| D10 - D16 | AXMT 0602..* |  SSV M1.8x4-9501 |  STK-T06-9906 |  0,6 |

*Suitable Insert brand is TGTC.





| Ordering Code | Item Designation | | Price | Master Insert* |
|---------------|------------------------------|---|-------|----------------|
| | <i>ST90 LN09 0904..</i> | | EURO | |
| SM35836 | ST90 LN09 D20 W20 L150 Z03-H | ✓ | 88 € | LNHU 0904.. |
| SM35843 | ST90 LN09 D25 W25 L150 Z04-H | ✓ | 103 € | |
| SM35850 | ST90 LN09 D32 W32 L150 Z05-H | ✓ | 106 € | |



| Ordering Code | Item Designation | | Price | Master Insert* |
|---------------|-----------------------------|---|-------|----------------|
| | <i>MT90 LN09 0904..</i> | | EURO | |
| SM54677 | MT90 LN09 D20 M10 L30 Z03-H | ✓ | 99 € | LNHU 0904.. |
| SM54684 | MT90 LN09 D25 M12 L35 Z04-H | ✓ | 116 € | |
| SM54691 | MT90 LN09 D32 M16 L43 Z05-H | ✓ | 127 € | |



| Ordering Code | Item Designation | | Price | Master Insert* |
|---------------|---|---|-------|----------------|
| | <i>TK90 LN09 / LN09 0904.. / 1306..</i> | | EURO | |
| SM32026 | TK90 LN09 D40 A16 Z05-H | ✓ | 74 € | LNHU 0904.. |
| SM32040 | TK90 LN09 D50 A22 Z06-H | ✓ | 93 € | |
| SM32064 | TK90 LN09 D63 A22 Z07-H | ✓ | 110 € | |
| SM32088 | TK90 LN09 D80 A27 Z09-H | ✓ | 128 € | |
| SM53236 | TK90 LN09 D40 A16 Z04-H | ✓ | 88 € | LNHU 1306.. |
| SM01392 | TK90 LN09 D50 A22 Z05-H | ✓ | 105 € | |
| SM53243 | TK90 LN09 D63 A22 Z06-H | ✓ | 116 € | |
| SM53250 | TK90 LN09 D80 A27 Z07-H | ✓ | 138 € | |
| SM53267 | TK90 LN09 D100 A32 Z09-H | ✓ | 204 € | |

Cooling mounting screw is optional / See Page 294 for cooling mounting screws.
İçten su vermeli montaj vidaları opsiyoneldir. / Bkz. Sayfa 294 İçten su vermeli montaj vidaları için.

Milling Tools

| Size Designation | Master Insert* | Spare Parts | | |
|------------------|----------------|---------------------|--------------|--------------------|
| | | Screw | Torx Key | Screw Torque Value |
| D20 | LNHU 0904..** | | | N·m |
| D25 - D38 | | SSV M3x6-9507 | | |
| D40 - D100 | LNHU 1306..** | SSV M3x8-9508 | STK-T08-9908 | 1,9 |
| | | SSV M4x12x5-9529 | STK-T15-9910 | 4,3 |

**Body corners should be modified for R2 and more radius inserts / R2 ve üstü radyüslü uçlarda takımın modifiye edilmesi gerekmektedir.

*Suitable Insert brand is WLTR.



| Ordering Code | Item Designation | | Price | Master Insert* |
|----------------------------------|------------------------------|---|-------|----------------|
| <i>ST90 LN.. 0804.. / 1306..</i> | | | EURO | |
| SM35935 | ST90 LN08 D16 W16 L150 Z02-H | ✓ | 103 € | LN.. 0804.. |
| SM35942 | ST90 LN08 D20 W20 L150 Z03-H | ✓ | 114 € | |
| SM35959 | ST90 LN08 D25 W25 L150 Z04-H | ✓ | 124 € | |
| SM35966 | ST90 LN08 D30 W25 L150 Z04-H | ✓ | 124 € | |
| SM35973 | ST90 LN08 D32 W32 L150 Z05-H | ✓ | 128 € | |
| SM59122 | ST90 LN13 D32 W32 L150 Z03-H | | 128 € | LN.. 1306.. |
| SM59139 | ST90 LN13 D40 W32 L150 Z04-H | | 168 € | |



| Ordering Code | Item Designation | | Price | Master Insert* |
|-------------------------|-----------------------------|---|-------|----------------|
| <i>MT90 LN.. 0804..</i> | | | EURO | |
| SM54950 | MT90 LN08 D20 M10 L30 Z03-H | ✓ | 99 € | LN.. 0804.. |
| SM54967 | MT90 LN08 D25 M12 L35 Z04-H | ✓ | 116 € | |
| SM54974 | MT90 LN08 D32 M16 L43 Z05-H | ✓ | 127 € | |



| Ordering Code | Item Designation | | Price | Master Insert* |
|----------------------------------|--------------------------|---|-------|----------------|
| <i>TK90 LN.. 0804.. / 1306..</i> | | | EURO | |
| SM31845 | TK90 LN08 D40 A16 Z05-H | ✓ | 74 € | LN.. 0804.. |
| SM31869 | TK90 LN08 D50 A22 Z06-H | ✓ | 93 € | |
| SM31883 | TK90 LN08 D63 A22 Z08-H | ✓ | 110 € | |
| SM31906 | TK90 LN08 D80 A27 Z09-H | ✓ | 128 € | |
| SM58446 | TK90 LN13 D40 A16 Z04-H | ✓ | 77 € | LN.. 1306.. |
| SM31937 | TK90 LN13 D50 A22 Z05-H | ✓ | 82 € | |
| SM31951 | TK90 LN13 D63 A22 Z06-H | ✓ | 100 € | |
| SM31975 | TK90 LN13 D80 A27 Z08-H | ✓ | 134 € | |
| SM31999 | TK90 LN13 D100 A32 Z09-H | ✓ | 167 € | |
| SM32002 | TK90 LN13 D125 B40 Z12 | ✓ | 202 € | |

Cooling mounting screw is optional / See Page 294 for cooling mounting screws.
İçten su vermeli montaj vidaları opsiyoneldir. / Bkz. Sayfa 294 İçten su vermeli montaj vidaları için.

| Size Designation | Master Insert* | Spare Parts | | |
|------------------|----------------|-----------------|--------------|--------------------|
| | | Screw | Torx Key | Screw Torque Value |
| D20 - D80 | LN..0804..** | SSV M2.5x7-9506 | STK-T08-9908 | 1,2 |
| D40 - D125 | LN.. 1306..** | SSV M4x10-9514 | STK-T15-9910 | 4,3 |

**Body corners should be modified for R2 and more radius inserts / R2 ve üstü radyüslü uçlarda takımın modifiye edilmesi gerekmektedir.

*Suitable Insert brand is ISC.



| Ordering Code | Item Designation | | Price | Master Insert* |
|---------------|------------------------------|---|-------------|----------------|
| | <i>ST90 LOEX 0804..</i> | | <i>EURO</i> | |
| SM58668 | ST90 LO08 D20 W20 L150 Z03-H | ✓ | 112 € | LOEX 0804.. |
| SM58675 | ST90 LO08 D25 W25 L150 Z04-H | ✓ | 122 € | |
| SM58682 | ST90 LO08 D32 W32 L150 Z05-H | ✓ | 125 € | |



| Ordering Code | Item Designation | | Price | Master Insert* |
|---------------|-----------------------------|---|-------------|----------------|
| | <i>MT90 LOEX 0804..</i> | | <i>EURO</i> | |
| SM58699 | MT90 LO08 D20 M10 L30 Z03-H | ✓ | 121 € | LOEX 0804.. |
| SM58705 | MT90 LO08 D25 M12 L35 Z04-H | ✓ | 132 € | |
| SM58712 | MT90 LO08 D32 M16 L43 Z05-H | ✓ | 138 € | |



| Ordering Code | Item Designation | | Price | Master Insert* |
|---------------|--------------------------------|---|-------------|----------------|
| | <i>TK90 LOEX 0804../1207..</i> | | <i>EURO</i> | |
| SM56893 | TK90 LO08 D40 A16 Z06-H | ✓ | 73 € | LOEX 0804.. |
| SM56909 | TK90 LO08 D50 A22 Z07-H | ✓ | 91 € | |
| SM56916 | TK90 LO08 D63 A22 Z08-H | ✓ | 108 € | |
| SM58729 | TK90 LO12 D40 A16 Z04-H | ✓ | 74 € | LOEX 1207.. |
| SM60333 | TK90 LO12 D50 A22 Z04-H | ✓ | 80 € | |
| SM58736 | TK90 LO12 D50 A22 Z05-H | ✓ | 88 € | |
| SM58743 | TK90 LO12 D63 A22 Z06-H | ✓ | 98 € | |
| SM58750 | TK90 LO12 D80 A27 Z07-H | ✓ | 132 € | |
| SM60340 | TK90 LO12 D80 A27 Z08-H | ✓ | 143 € | |
| SM58767 | TK90 LO12 D100 A32 Z09-H | ✓ | 164 € | |

Milling Tools

| Size Designation | Master Insert* | Spare Parts | | |
|------------------|----------------|-------------------------|------------------|--------------------|
| | | Screw | Torx Key | Screw Torque Value |
| D20 - D63 | LOEX 0804..** | SSV M2.5x7-9506 | STK-T08-9908 | 1,2 |
| D40 - D100 | LOEX 1207..** | SSV M3.5x12-9526 | STK-T15-9910 | 3,9 |

**Body corners should be modified for R2 and more radius inserts / R2 ve üstü radyüslü uçlarda takımın modifiye edilmesi gerekmektedir.

*Suitable Insert brand is SCO.



| Ordering Code | Item Designation | | Price | Master Insert* |
|--------------------------------|------------------------------|---|-------------|----------------|
| <i>ST90 LPHU / LPKU 0904..</i> | | | <i>EURO</i> | |
| SM58491 | ST90 LP09 D20 W20 L150 Z03-H | ✓ | 112 € | LPU 0904.. |
| SM58507 | ST90 LP09 D25 W25 L150 Z04-H | ✓ | 122 € | |
| SM58514 | ST90 LP09 D32 W32 L150 Z05-H | ✓ | 125 € | |



| Ordering Code | Item Designation | | Price | Master Insert* |
|--------------------------------|-----------------------------|---|-------------|----------------|
| <i>MT90 LPHU / LPKU 0904..</i> | | | <i>EURO</i> | |
| SM58521 | MT90 LP09 D20 M10 L30 Z03-H | ✓ | 121 € | LPU 0904.. |
| SM58538 | MT90 LP09 D25 M12 L35 Z04-H | ✓ | 132 € | |
| SM58545 | MT90 LP09 D32 M16 L43 Z05-H | ✓ | 138 € | |



| Ordering Code | Item Designation | | Price | Master Insert* |
|--------------------------------|-------------------------|---|-------------|----------------|
| <i>TK90 LPHU / LPKU 0904..</i> | | | <i>EURO</i> | |
| SM55278 | TK90 LP09 D40 A16 Z05-H | ✓ | 78 € | LPU 0904.. |
| SM55285 | TK90 LP09 D50 A22 Z06-H | ✓ | 93 € | |
| SM55292 | TK90 LP09 D63 A22 Z07-H | ✓ | 110 € | |

Cooling mounting screw is optional / See Page 294 for cooling mounting screws.
İçten su vermeli montaj vidaları opsiyoneldir. / Bkz. Sayfa 294 İçten su vermeli montaj vidaları için.



Milling Tools

| Size Designation | Master Insert* | Spare Parts | | |
|------------------|----------------|---------------|--------------|--------------------|
| | | Screw | Torx Key | Screw Torque Value |
| D20 - D32 | LPU 0904..** | | | |
| D40 - D63 | | SSV M3x7-9527 | STK-T08-9908 | 1,9 |
| | | SSV M3x8-9508 | | |

**Body corners should be modified for R2 and more radius inserts / R2 ve üstü radyüslü uçlarda takımın modifiye edilmesi gerekmektedir.

*Suitable Insert brand is TGTC.



| Ordering Code | Item Designation | | Price | Master Insert* |
|---------------|------------------------------|---|-------|----------------|
| | <i>ST90 LOGU 0904</i> | | EURO | |
| SM55094 | ST90 LO09 D20 W20 L150 Z03-H | ✓ | 114 € | LOGU 0904.. |
| SM55100 | ST90 LO09 D25 W25 L150 Z04-H | ✓ | 124 € | |
| SM55117 | ST90 LO09 D32 W32 L150 Z05-H | ✓ | 128 € | |



| Ordering Code | Item Designation | | Price | Master Insert* |
|---------------|-----------------------------|---|-------|----------------|
| | <i>MT90 LOGU 0904</i> | | EURO | |
| SM52772 | MT90 LO09 D20 M10 L30 Z03-H | ✓ | 123 € | LOGU 0904.. |
| SM52789 | MT90 LO09 D25 M12 L35 Z04-H | ✓ | 134 € | |
| SM52796 | MT90 LO09 D32 M16 L43 Z05-H | ✓ | 140 € | |



| Ordering Code | Item Designation | | Price | Master Insert* |
|---------------|-------------------------|---|-------|----------------|
| | <i>TK90 LOGU 0904</i> | | EURO | |
| SM52734 | TK90 LO09 D40 A16 Z05-H | ✓ | 78 € | LOGU 0904.. |
| SM52741 | TK90 LO09 D50 A22 Z06-H | ✓ | 93 € | |
| SM52758 | TK90 LO09 D63 A22 Z07-H | ✓ | 110 € | |
| SM52765 | TK90 LO09 D80 A27 Z09-H | ✓ | 157 € | |

Cooling mounting screw is optional / See Page 294 for cooling mounting screws.
İçten su vermeli montaj vidaları opsiyoneldir. / Bkz. Sayfa 294 İçten su vermeli montaj vidaları için.

Milling Tools

| Size Designation | Master Insert* | Spare Parts | | |
|------------------|----------------|------------------------|------------------|--------------------|
| | | Screw | Torx Key | Screw Torque Value |
| D20 - D80 | LOGU 0904..** | SSV M2.5x7-9506 | STK-T08-9908 | N·m 1,2 |

**Body corners should be modified for R2 and more radius inserts / R2 ve üstü radyüslü uçlarda takımın modifiye edilmesi gerekmektedir.

*Suitable Insert brand is MTSBH.



| Ordering Code | Item Designation | | Price | Master Insert* |
|---------------|------------------------------|---|-------|---------------------|
| | ST90 LN..1106..T490 | | EURO | |
| SM59016 | ST90 LN11 D25 W25 L150 Z03-H | ✓ | 132 € | LN.. 1106.. T490 |
| SM59023 | ST90 LN11 D32 W32 L150 Z04-H | ✓ | 138 € | |



| Ordering Code | Item Designation | | Price | Master Insert* |
|---------------|----------------------------|---|-------|---------------------|
| | TK90 LN..1106..T490 | | EURO | |
| SM55124 | TK90 LN11 D40 A16 Z04-H | ✓ | 85 € | LN.. 1106.. T490 |
| SM55131 | TK90 LN11 D40 A16 Z05-H | ✓ | 91 € | |
| SM55148 | TK90 LN11 D50 A22 Z05-H | ✓ | 126 € | |
| SM55155 | TK90 LN11 D50 A22 Z06-H | ✓ | 132 € | |
| SM55162 | TK90 LN11 D63 A22 Z06-H | ✓ | 141 € | |
| SM55179 | TK90 LN11 D63 A22 Z09-H | ✓ | 182 € | |
| SM55186 | TK90 LN11 D80 A27 Z08-H | ✓ | 195 € | |
| SM55193 | TK90 LN11 D80 A27 Z11-H | ✓ | 237 € | |

| Size Designation | Master Insert* | Spare Parts | | |
|------------------|----------------|------------------|--------------|--------------------|
| | | Screw | Torx Key | Screw Torque Value |
| D25 - D32 | LN.. 1106..** | SSV M3.5x10-9511 | STK-T15-9910 | 2,9 |
| D40 - D80 | | SSV M3.5x12-9526 | | |

Cooling mounting screw is optional / See Page 294 for cooling mounting screws.

İçten su vermeli montaj vidaları opsiyoneldir. / Bkz. Sayfa 294 İçten su vermeli montaj vidaları için.

**Body corners should be modified for R2 and more radius inserts / R2 ve üstü radyüslü uçlarda takımın modifiye edilmesi gerekmektedir.

*Suitable Insert brand is ISC.



| Ordering Code | Item Designation | | Price | Master Insert* |
|---------------|----------------------------|---|-------|----------------|
| | TK90 LNKT 1506.. | | EURO | |
| SM31500 | TK90 LNKT15 D50 A22 Z04-H | ✓ | 93 € | LNKT 1506.. |
| SM31524 | TK90 LNKT15 D63 A22 Z05-H | ✓ | 106 € | |
| SM31548 | TK90 LNKT15 D80 A27 Z06-H | ✓ | 128 € | |
| SM31562 | TK90 LNKT15 D100 A32 Z07-H | ✓ | 170 € | |
| SM31579 | TK90 LNKT15 D125 B40 Z08 | ✓ | 213 € | |

| Size Designation | Master Insert* | Spare Parts | | |
|------------------|----------------|-------------------|--------------|--------------------|
| | | Screw | Torx Key | Screw Torque Value |
| D50 - D125 | LNKT 1506.. | SSV M4x12-9515 | STK-T15-9910 | 4,3 |

Cooling mounting screw is optional / See Page 294 for cooling mounting screws.

İçten su vermeli montaj vidaları opsiyoneldir. / Bkz. Sayfa 294 İçten su vermeli montaj vidaları için.



| Ordering Code | Item Designation | | Price | Master Insert* |
|---------------|--------------------------|---|-------|----------------|
| | TK90 LNKT 1707.. | | EURO | |
| SM44111 | TK90 LN17 D50 A22 Z05-H | ✓ | 106 € | LNKT 1707.. |
| SM44128 | TK90 LN17 D63 A22 Z06-H | ✓ | 128 € | |
| SM44135 | TK90 LN17 D80 A27 Z07-H | ✓ | 151 € | |
| SM44142 | TK90 LN17 D100 A32 Z09-H | ✓ | 202 € | |

| Size Designation | Master Insert* | Spare Parts | | |
|------------------|----------------|----------------|--------------|--------------------|
| | | Screw | Torx Key | Screw Torque Value |
| D50 - D100 | LNKT 1707.. | SSV M4x12-9515 | STK-T15-9910 | 4,3 N-m |

*Suitable Insert brand is KRLY. Cooling mounting screw is optional / See Page 294 for cooling mounting screws. İçten su vermeli montaj vidaları opsiyoneldir. / Bkz. Sayfa 294 İçten su vermeli montaj vidaları için.



| Ordering Code | Item Designation | | Price | Master Insert* |
|---------------|--------------------------------|---|-------|----------------|
| | ST90 ANKX / ANCX 0904.. | | EURO | |
| SM58583 | ST90 AN09 D16 W16 L150 Z02-H | ✓ | 70 € | AN.X 0904.. |
| SM58590 | ST90 AN09 D20 W20 L150 Z03-H | ✓ | 101 € | |
| SM58606 | ST90 AN09 D25 W25 L150 Z04-H | ✓ | 123 € | |
| SM58613 | ST90 AN09 D32 W32 L150 Z05-H | ✓ | 138 € | |



| Ordering Code | Item Designation | | Price | Master Insert* |
|---------------|--------------------------------|---|-------|----------------|
| | MT90 ANKX / ANCX 0904.. | | EURO | |
| SM58552 | MT90 AN09 D20 M10 L30 Z03-H | ✓ | 110 € | AN.X 0904.. |
| SM58569 | MT90 AN09 D25 M12 L35 Z04-H | ✓ | 116 € | |
| SM58576 | MT90 AN09 D32 M16 L43 Z05-H | ✓ | 123 € | |



| Ordering Code | Item Designation | | Price | Master Insert* |
|---------------|--|---|-------|----------------|
| | TK90 ANKX / ANCX 0904.. / 1205.. / 1706.. | | EURO | |
| SM54615 | TK90 AN09 D40 A16 Z05-H | | 88 € | AN.X 0904.. |
| SM54622 | TK90 AN09 D40 A16 Z06-H | | 92 € | |
| SM54646 | TK90 AN09 D50 A22 Z06-H | | 98 € | |
| SM54639 | TK90 AN09 D50 A22 Z07-H | | 110 € | |
| SM54653 | TK90 AN09 D63 A22 Z08-H | | 113 € | |
| SM54660 | TK90 AN09 D63 A22 Z09-H | | 121 € | |
| SM31678 | TK90 AN12 D50 A22 Z04-H | ✓ | 85 € | AN.X 1205.. |
| SM31692 | TK90 AN12 D63 A22 Z05-H | ✓ | 88 € | |
| SM31715 | TK90 AN12 D80 A27 Z07-H | ✓ | 118 € | |
| SM31739 | TK90 AN12 D100 A32 Z09-H | ✓ | 156 € | AN.X 1706.. |
| SM31753 | TK90 AN17 D50 A22 Z04-H | ✓ | 93 € | |
| SM31777 | TK90 AN17 D63 A22 Z06-H | ✓ | 103 € | |
| SM31791 | TK90 AN17 D80 A27 Z07-H | ✓ | 131 € | |
| SM31814 | TK90 AN17 D100 A32 Z08-H | ✓ | 164 € | |
| SM31821 | TK90 AN17 D125 B40 Z10 | - | 206 € | |

| Size Designation | Master Insert* | Spare Parts | | |
|------------------|----------------|------------------|--------------|--------------------|
| | | Screw | Torx Key | Screw Torque Value |
| D40 - D63 | AN.X 0904..** | SSV M3x6 LG-9509 | STK-T08-9908 | 1,9 |
| D50 - D63 | AN.X 1205..** | SSV M4x9x5-9528 | STK-T15-9910 | 4,3 |
| D80 - D100 | | SSV M4x12x5-9529 | | |
| D50 - D125 | AN.X 1706..** | SSV M5x13-9519 | STK-T20-9911 | 8,5 |

**Body corners should be modified for R2 and more radius inserts / R2 ve üstü radyüslü uçlarda takımın modifiye edilmesi gerekmektedir.

*Suitable Insert brand is ISC.



| Ordering Code | Item Designation | | Price | Master Insert* |
|---------------|----------------------------------|---|-------------|----------------|
| | <i>ST90 LN.X 1006.. / 1510..</i> | | <i>EURO</i> | |
| SM22911 | ST90 LN10 D16 W16 L120 Z01 | - | 57 € | LN.X 1006.. |
| SM51614 | ST90 LN10 D16 W16 L120 Z01-H | ✓ | 65 € | |
| SM22904 | ST90 LN10 D18 W16 L120 Z02 | - | 71 € | |
| SM22898 | ST90 LN10 D20 W20 L150 Z02 | - | 82 € | |
| SM51621 | ST90 LN10 D20 W20 L150 Z02-H | ✓ | 93 € | |
| SM26711 | ST90 LN10 D22 W20 L150 Z02 | - | 82 € | |
| SM22881 | ST90 LN10 D25 W25 L150 Z03 | - | 100 € | |
| SM51638 | ST90 LN10 D25 W25 L150 Z03-H | ✓ | 114 € | |
| SM22874 | ST90 LN10 D32 W32 L150 Z04 | - | 106 € | |
| SM22867 | ST90 LN10 D40 W32 L150 Z05 | - | 114 € | |
| SM22805 | ST90 LN15 D32 W32 L150 Z02 | - | 106 € | LN.X 1510.. |
| SM51645 | ST90 LN15 D32 W32 L150 Z02-H | ✓ | 122 € | |
| SM22812 | ST90 LN15 D32 C32 L250 Z02 | - | 134 € | |
| SM22775 | ST90 LN15 D32 C32 L300 Z02 | - | 134 € | |
| SM22829 | ST90 LN15 D35 W32 L150 Z03 | - | 128 € | |
| SM22836 | ST90 LN15 D35 C32 L250 Z03 | - | 134 € | |
| SM22782 | ST90 LN15 D35 C32 L300 Z03 | - | 153 € | |
| SM22843 | ST90 LN15 D40 W32 L150 Z03 | - | 139 € | |
| SM51652 | ST90 LN15 D40 W32 L150 Z03-H | ✓ | 159 € | |
| SM22850 | ST90 LN15 D40 C32 L250 Z03 | - | 146 € | |
| SM22799 | ST90 LN15 D40 C32 L300 Z03 | - | 166 € | |



| Ordering Code | Item Designation | | Price | Master Insert* |
|---------------|-----------------------------|---|-------------|----------------|
| | <i>MT90 LN.X 1006..</i> | | <i>EURO</i> | |
| SM47549 | MT90 LN10 D20 M10 L30 Z02-H | ✓ | 104 € | LN.X 1006.. |
| SM47556 | MT90 LN10 D25 M12 L35 Z03-H | ✓ | 109 € | |
| SM47563 | MT90 LN10 D32 M16 L43 Z04-H | ✓ | 115 € | |



| Ordering Code | Item Designation | | Price | Master Insert* |
|---------------|----------------------------------|---|-------------|----------------|
| | <i>TK90 LN.X 1006.. / 1510..</i> | | <i>EURO</i> | |
| SM22690 | TK90 LN10 D40 A16 Z05-H | ✓ | 82 € | LN.X 1006.. |
| SM28456 | TK90 LN10 D50 A22 Z06-H | ✓ | 91 € | |
| SM22713 | TK90 LN10 D63 A22 Z07-H | ✓ | 102 € | |
| SM28432 | TK90 LN15 D50 A22 Z05-H | ✓ | 99 € | LN.X 1510.. |
| SM28425 | TK90 LN15 D63 A22 Z06-H | ✓ | 119 € | |
| SM28418 | TK90 LN15 D80 A27 Z07-H | ✓ | 134 € | |
| SM28401 | TK90 LN15 D100 A32 Z09-H | ✓ | 166 € | |
| SM38479 | TK90 LN15 D125 B40 Z10 | - | 243 € | |
| SM38486 | TK90 LN15 D160 C40 Z12 | - | 284 € | |

Cooling mounting screw is optional / See Page 294 for cooling mounting screws.
İçten su vermeli montaj vidaları opsiyoneldir. / Bkz. Sayfa 294 İçten su vermeli montaj vidaları için.

| Size Designation | Master Insert* | Spare Parts | | |
|------------------|----------------|------------------|--------------|---------------------------|
| | | Screw | Torx Key | Screw Torque Value N-m |
| D16 - D22 | LN.X 1006.. | SSV M3x6-9507 | STK-T08-9908 | 1,9 |
| D25 - D40 | | SSV M3x8-9508 | | |
| D50 - D160 | LN.X 1510.. | SSV M4x12x5-9529 | STK-T15-9910 | 4,3 |



| Ordering Code | Item Designation | | Price | Master Insert* |
|-------------------------|------------------------------|---|-------------|----------------|
| <i>ST90 LOMU 1004..</i> | | | <i>EURO</i> | |
| SM51607 | ST90 LM10 D16 W16 L120 Z02-H | ✓ | 100 € | LOMU 1004.. |
| SM43701 | ST90 LM10 D16 W16 L150 Z02-H | ✓ | 110 € | |
| SM53984 | ST90 LM10 D18 W16 L150 Z02-H | ✓ | 112 € | |
| SM49765 | ST90 LM10 D20 W20 L120 Z03-H | ✓ | 108 € | |
| SM43718 | ST90 LM10 D20 W20 L150 Z03-H | ✓ | 119 € | |
| SM61118 | ST90 LM10 D21 W20 L150 Z03-H | ✓ | 123 € | |
| SM53991 | ST90 LM10 D22 W20 L150 Z03-H | ✓ | 123 € | |
| SM39858 | ST90 LM10 D25 W25 L120 Z03-H | ✓ | 129 € | |
| SM43725 | ST90 LM10 D25 W25 L150 Z03-H | ✓ | 143 € | |
| SM54004 | ST90 LM10 D26 W25 L150 Z03-H | ✓ | 143 € | |
| SM49772 | ST90 LM10 D32 W32 L120 Z04-H | ✓ | 139 € | |
| SM49789 | ST90 LM10 D32 W32 L150 Z04-H | ✓ | 151 € | |
| SM54011 | ST90 LM10 D33 W32 L150 Z04-H | ✓ | 151 € | |



| Ordering Code | Item Designation | | Price | Master Insert* |
|-------------------------|-----------------------------|---|-------------|----------------|
| <i>MT90 LOMU 1003..</i> | | | <i>EURO</i> | |
| SM50464 | MT90 LM10 D16 M08 L25 Z02-H | ✓ | 103 € | LOMU 1004.. |
| SM43749 | MT90 LM10 D20 M10 L30 Z03-H | ✓ | 120 € | |
| SM43756 | MT90 LM10 D25 M12 L35 Z03-H | ✓ | 127 € | |
| SM43763 | MT90 LM10 D32 M16 L43 Z04-H | ✓ | 131 € | |



| Ordering Code | Item Designation | | Price | Master Insert* |
|----------------------------------|--------------------------|---|-------------|----------------|
| <i>TK90 LOMU 1003.. / 1505..</i> | | | <i>EURO</i> | |
| SM46238 | TK90 LM10 D40 A16 Z05-H | ✓ | 127 € | LOMU 1004.. |
| SM46245 | TK90 LM10 D50 A22 Z05-H | ✓ | 151 € | |
| SM46252 | TK90 LM10 D63 A22 Z06-H | ✓ | 185 € | |
| SM46191 | TK90 LM15 D40 A16 Z04-H | ✓ | 96 € | LOMU 1505.. |
| SM46207 | TK90 LM15 D50 A22 Z05-H | ✓ | 106 € | |
| SM46214 | TK90 LM15 D63 A22 Z06-H | ✓ | 131 € | |
| SM46221 | TK90 LM15 D80 A27 Z07-H | ✓ | 165 € | |
| SM01828 | TK90 LM15 D100 A32 Z08-H | ✓ | 185 € | |

Cooling mounting screw is optional / See Page 294 for cooling mounting screws.
İçten su vermeli montaj vidaları opsiyoneldir. / Bkz. Sayfa 294 İçten su vermeli montaj vidaları için.

| Size Designation | Master Insert* | Spare Parts | | |
|------------------|----------------|-------------------------|------------------|--------------------|
| | | Screw | Torx Key | Screw Torque Value |
| D16 - D63 | LOMU 1004..** | SSV M3x6 LG-9509 | STK-T08-9908 | 1,9 |
| D40 - D63 | LOMU 1505..** | SSV M4x9x5-9528 | STK-T15-9910 | 4,3 |
| D80 - D100 | | SSV M4x12x5-9529 | | |

**Body corners should be modified for R2 and more radius inserts / R2 ve üstü radyüslü uçlarda takımın modifiye edilmesi gerekmektedir.

*Suitable Insert brand is KYCR.



| Ordering Code | Item Designation | | Price | Master Insert* |
|---------------|------------------------------|---|-------|----------------|
| | <i>ST90 ANGX 1105..</i> | | EURO | |
| SM35980 | ST90 AN11 D25 W25 L150 Z02-H | ✓ | 100 € | ANGX 1105.. |
| SM35997 | ST90 AN11 D32 W32 L150 Z03-H | ✓ | 106 € | |



| Ordering Code | Item Designation | | Price | Master Insert* |
|---------------|----------------------------------|---|-------|----------------|
| | <i>TK90 ANGX 1105.. / 1506..</i> | | EURO | |
| SM31364 | TK90 AN11 D40 A16 Z05-H | ✓ | 77 € | ANGX 1105.. |
| SM31388 | TK90 AN11 D50 A22 Z06-H | ✓ | 85 € | |
| SM31401 | TK90 AN11 D63 A22 Z07-H | ✓ | 106 € | |
| SM31425 | TK90 AN15 D50 A22 Z04-H | ✓ | 85 € | ANGX 1506.. |
| SM31449 | TK90 AN15 D63 A22 Z05-H | ✓ | 96 € | |
| SM31463 | TK90 AN15 D80 A27 Z07-H | ✓ | 118 € | |
| SM31487 | TK90 AN15 D100 A32 Z09-H | ✓ | 156 € | |

Cooling mounting screw is optional / See Page 294 for cooling mounting screws.
İçten su vermeli montaj vidaları opsiyoneldir. / Bkz. Sayfa 294 İçten su vermeli montaj vidaları için.

*Suitable Insert brand is ZCC-CT.

| Size Designation | Master Insert* | Spare Parts | | |
|------------------|----------------|-------------------------|------------------|--------------------|
| | | Screw | Torx Key | Screw Torque Value |
| D25 - D63 | ANGX 1105.. | SSV M3x8-9508 | STK-T08-9908 | 1,9 |
| D50 - D100 | ANGX 1506.. | SSV M4x12x5-9529 | STK-T15-9910 | 4,3 |



| Ordering Code | Item Designation | | Price | Master Insert* |
|---------------|------------------------------|---|-------|----------------|
| | <i>ST90 LQMU 1107..</i> | | EURO | |
| SM46054 | ST90 LQ11 D25 W25 L150 Z02-H | ✓ | 100 € | LQMU 1107.. |
| SM46061 | ST90 LQ11 D32 W32 L150 Z03-H | ✓ | 106 € | |



| Ordering Code | Item Designation | | Price | Master Insert* |
|---------------|-------------------------|---|-------|----------------|
| | <i>TK90 LQMU 1107..</i> | | EURO | |
| SM45996 | TK90 LQ11 D40 A16 Z04-H | ✓ | 88 € | LQMU 1107.. |
| SM46009 | TK90 LQ11 D50 A22 Z05-H | ✓ | 99 € | |
| SM46016 | TK90 LQ11 D63 A22 Z06-H | ✓ | 119 € | |

Cooling mounting screw is optional / See Page 294 for cooling mounting screws.
İçten su vermeli montaj vidaları opsiyoneldir. / Bkz. Sayfa 294 İçten su vermeli montaj vidaları için.

*Suitable Insert brand is TNGLY.

| Size Designation | Master Insert* | Spare Parts | | |
|------------------|----------------|---------------------------|------------------|--------------------|
| | | Screw | Torx Key | Screw Torque Value |
| D25 - D63 | LQMU 1107.. | SSV M3.5x8 SC-9513 | STK-T08-9908 | 2,9 |



| Ordering Code | Item Designation | | Price | Master Insert* |
|---------------|----------------------------|---|-------|----------------|
| | ST90 LNGX 1205.. | | EURO | |
| SM35867 | ST90 LN12 D25 W25 L150 Z02 | ✓ | 100 € | LNGX 1205.. |
| SM35874 | ST90 LN12 D32 W32 L150 Z03 | ✓ | 106 € | |



| Ordering Code | Item Designation | | Price | Master Insert* |
|---------------|--------------------------|---|-------|----------------|
| | TK90 LNGX 1205.. | | EURO | |
| SM31593 | TK90 LN12 D50 A22 Z05-H | ✓ | 85 € | LNGX 1205.. |
| SM31616 | TK90 LN12 D63 A22 Z06-H | ✓ | 106 € | |
| SM31630 | TK90 LN12 D80 A27 Z07-H | ✓ | 118 € | |
| SM31654 | TK90 LN12 D100 A32 Z09-H | ✓ | 156 € | |

*Suitable Insert brand is PRMT.

| Size Designation | Master Insert* | Spare Parts | | |
|------------------|----------------|-------------------------|------------------|--------------------|
| | | Screw | Torx Key | Screw Torque Value |
| D25 - D100 | LNGX 1205.. | SSV M3.5x10-9511 | STK-T15-9910 | N-m 4,3 |



Milling Tools



| Ordering Code | Item Designation | | Price | Master Insert* |
|---------------|--------------------------|---|-------|----------------|
| | TK90 AN.X 1607.. | | EURO | |
| SM13940 | TK90 AN16 D50 A22 Z04-H | ✓ | 91 € | AN.X 1607.. |
| SM13957 | TK90 AN16 D63 A22 Z06-H | ✓ | 108 € | |
| SM13964 | TK90 AN16 D80 A27 Z07-H | ✓ | 122 € | |
| SM28531 | TK90 AN16 D100 A32 Z08-H | ✓ | 147 € | |

*Suitable Insert brand is TGTC.

| Size Designation | Master Insert* | Spare Parts | | |
|------------------|----------------|-----------------------|------------------|--------------------|
| | | Screw | Torx Key | Screw Torque Value |
| D50 - D100 | AN.X 1607.. | SSV M4x10-9514 | STK-T15-9910 | N-m 4,3 |

Cooling mounting screw is optional / See Page 294 for cooling mounting screws.
İçten su vermeli montaj vidaları opsiyoneldir. / Bkz. Sayfa 294 İçten su vermeli montaj vidaları için.



| Ordering Code | Item Designation | | Price | Master Insert* |
|-------------------------|----------------------------|---|-------------|----------------|
| <i>TK90 LNGU 15T6..</i> | | | <i>EURO</i> | |
| SM42704 | TK90 LNGU15 D40 A16 Z04-H | ✓ | 88 € | LNGU 15T6.. |
| SM40472 | TK90 LNGU15 D50 A22 Z05-H | ✓ | 99 € | |
| SM42711 | TK90 LNGU15 D63 A22 Z06-H | ✓ | 119 € | |
| SM42827 | TK90 LNGU15 D80 A27 Z07-H | ✓ | 151 € | |
| SM42834 | TK90 LNGU15 D100 A32 Z08-H | ✓ | 180 € | |

*Suitable Insert brand is KNMTL.

| Size Designation | Master Insert* | Spare Parts | | |
|------------------|----------------|-----------------------|------------------|--------------------|
| | | Screw | Torx Key | Screw Torque Value |
| D40 - D100 | LNGU 15T6.. | SSV M4x12-9515 | STK-T15-9910 | N-m 4,3 |



| Ordering Code | Item Designation | | Price | Master Insert* |
|-------------------------|--------------------------|---|-------------|----------------|
| <i>TK90 XNPU 15T6..</i> | | | <i>EURO</i> | |
| SM42728 | TK90 XN15 D40 A16 Z04-H | ✓ | 88 € | XNPU 15T6.. |
| SM40489 | TK90 XN15 D50 A22 Z05-H | ✓ | 99 € | |
| SM42735 | TK90 XN15 D63 A22 Z06-H | ✓ | 119 € | |
| SM42766 | TK90 XN15 D80 A27 Z07-H | ✓ | 151 € | |
| SM42773 | TK90 XN15 D100 A32 Z08-H | ✓ | 180 € | |

*Suitable Insert brand is WDA.

| Size Designation | Master Insert* | Spare Parts | | |
|------------------|----------------|-------------------------|------------------|--------------------|
| | | Screw | Torx Key | Screw Torque Value |
| D40 - D100 | XNPU 15T6.. | SSV M4x10x5-9528 | STK-T15-9910 | N-m 4,3 |



| Ordering Code | Item Designation | | Price | Master Insert* |
|-------------------------|----------------------------|---|-------------|----------------|
| <i>TK90 LNGX 1307..</i> | | | <i>EURO</i> | |
| SM28685 | TK90 LNGX13 D50 A22 Z04-H | ✓ | 96 € | LNGX 1307.. |
| SM28678 | TK90 LNGX13 D63 A22 Z05-H | ✓ | 106 € | |
| SM28661 | TK90 LNGX13 D80 A27 Z06-H | ✓ | 134 € | |
| SM31913 | TK90 LNGX13 D100 A32 Z07-H | ✓ | 180 € | |
| SM14169 | TK90 LNGX13 D125 B40 Z08 | - | 223 € | |

*Suitable Insert brand is WLTR.

| Size Designation | Master Insert* | Spare Parts | | |
|------------------|----------------|----------------------------|------------------|--------------------|
| | | Screw | Torx Key | Screw Torque Value |
| D50 - D125 | LNGX 1307..* | SSV M3.5x12-SC-9531 | STK-T10-9909 | N-m 2,9 |

Cooling mounting screw is optional / See Page 294 for cooling mounting screws.
İçten su vermeli montaj vidaları opsiyoneldir. / Bkz. Sayfa 294 İçten su vermeli montaj vidaları için.



| Ordering Code | Item Designation | | Price | Master Insert* |
|-------------------------|------------------------------|---|-------------|----------------|
| <i>ST90 4NKT 0603..</i> | | | <i>EURO</i> | |
| SM35423 | ST90 4N06 D16 W16 L120 Z02-H | ✓ | 77 € | 4NKT 0603.. |
| SM35447 | ST90 4N06 D16 W16 L150 Z02 | - | 100 € | |
| SM53632 | ST90 4N06 D16 W16 L150 Z02-H | ✓ | 116 € | |
| SM53755 | ST90 4N06 D17 W16 L150 Z02-H | ✓ | 116 € | |
| SM35430 | ST90 4N06 D20 W20 L120 Z03-H | ✓ | 85 € | |
| SM35454 | ST90 4N06 D20 W20 L150 Z03 | - | 106 € | |
| SM53649 | ST90 4N06 D20 W20 L150 Z03-H | ✓ | 121 € | |
| SM53779 | ST90 4N06 D21 W20 L150 Z03-H | ✓ | 121 € | |
| SM35461 | ST90 4N06 D25 W25 L150 Z03 | - | 118 € | |
| SM53656 | ST90 4N06 D25 W25 L150 Z03-H | ✓ | 132 € | |
| SM53793 | ST90 4N06 D26 W25 L150 Z03-H | ✓ | 132 € | |
| SM35478 | ST90 4N06 D32 W32 L150 Z04 | - | 124 € | |
| SM53663 | ST90 4N06 D32 W32 L150 Z04-H | ✓ | 146 € | |



| Ordering Code | Item Designation | | Price | Master Insert* |
|-------------------------|-----------------------------|---|-------------|----------------|
| <i>MT90 4NKT 0603..</i> | | | <i>EURO</i> | |
| SM53748 | MT90 4N06 D16 M08 L25 Z02-H | ✓ | 90 € | 4NKT 0603.. |
| SM53762 | MT90 4N06 D20 M10 L30 Z03-H | ✓ | 114 € | |
| SM53786 | MT90 4N06 D25 M12 L35 Z03-H | ✓ | 119 € | |
| SM53809 | MT90 4N06 D32 M16 L43 Z04-H | ✓ | 127 € | |
| SM53816 | MT90 4N06 D35 M16 L43 Z05-H | ✓ | 131 € | |
| SM53823 | MT90 4N06 D40 M16 L43 Z05-H | ✓ | 137 € | |
| SM53830 | MT90 4N06 D42 M16 L43 Z05-H | ✓ | 139 € | |



| Ordering Code | Item Designation | | Price | Master Insert* |
|-------------------------|-------------------------|---|-------------|----------------|
| <i>TK90 4NKT 0603..</i> | | | <i>EURO</i> | |
| SM32408 | TK90 4N06 D40 A16 Z05-H | ✓ | 93 € | 4NKT 0603.. |
| SM32422 | TK90 4N06 D50 A22 Z06-H | ✓ | 106 € | |
| SM32446 | TK90 4N06 D63 A22 Z07-H | ✓ | 128 € | |

Cooling mounting screw is optional / See Page 294 for cooling mounting screws.
İçten su vermeli montaj vidaları opsiyoneldir. / Bkz. Sayfa 294 İçten su vermeli montaj vidaları için.

| Size Designation | Master Insert* | Spare Parts | | |
|------------------|----------------|-------------------------|------------------|--------------------|
| | | Screw | Torx Key | Screw Torque Value |
| D16 - D63 | | SSV M3x6 LG-9509 | STK-T08-9908 | N·m 1,9 |

**Body corners should be modified for R2 and more radius inserts / R2 ve üstü radyüslü uçlarda takımın modifiye edilmesi gerekmektedir.

*Suitable Insert brand is TGTC.



| Ordering Code | Item Designation | | Price | Master Insert* |
|----------------------------------|--------------------------------|---|-------------|----------------|
| <i>ST90 XNKT 0604.. / 0805..</i> | | | <i>EURO</i> | |
| SM27282 | ST90 XNKT06 D20 W20 L150 Z02-H | ✓ | 103 € | XNKT 0604.. |
| SM24540 | ST90 XNKT06 D21 W20 L150 Z02-H | ✓ | 114 € | |
| SM36666 | ST90 XNKT06 D21 C20 L200 Z02 | - | 142 € | |
| SM36642 | ST90 XNKT06 D22 W20 L150 Z02-H | ✓ | 115 € | |
| SM24557 | ST90 XNKT06 D25 W25 L150 Z03-H | ✓ | 121 € | |
| SM27299 | ST90 XNKT06 D26 W25 L150 Z03-H | ✓ | 124 € | |
| SM36680 | ST90 XNKT06 D26 C25 L200 Z03 | - | 149 € | |
| SM36659 | ST90 XNKT06 D32 W32 L150 Z04-H | ✓ | 134 € | |
| SM27305 | ST90 XNKT06 D33 W32 L150 Z04-H | ✓ | 139 € | |
| SM36703 | ST90 XNKT06 D33 C32 L200 Z04 | - | 181 € | |
| SM39247 | ST90 XNKT08 D30 W25 L150 Z02 | - | 149 € | XNKT 08.. |
| SM39254 | ST90 XNKT08 D32 W32 L150 Z02 | - | 149 € | |
| SM39261 | ST90 XNKT08 D35 W32 L150 Z03 | - | 159 € | |
| SM39278 | ST90 XNKT08 D40 W32 L150 Z04 | - | 177 € | |



| Ordering Code | Item Designation | | Price | Master Insert* |
|----------------------------------|-------------------------------|---|-------------|----------------|
| <i>MT90 XNKT 0604.. / 0805..</i> | | | <i>EURO</i> | |
| SM40458 | MT90 XNKT06 D20 M10 L30 Z02-H | ✓ | 104 € | XNKT 0604.. |
| SM40427 | MT90 XNKT06 D25 M12 L35 Z03-H | ✓ | 110 € | |
| SM40434 | MT90 XNKT06 D32 M16 L43 Z04-H | ✓ | 118 € | |
| SM40465 | MT90 XNKT06 D40 M16 L43 Z05-H | ✓ | 125 € | |
| SM40441 | MT90 XNKT06 D42 M16 L43 Z05-H | ✓ | 125 € | |
| SM43497 | MT90 XNKT08 D30 M16 L43 Z02-H | ✓ | 118 € | XNKT 08.. |
| SM43503 | MT90 XNKT08 D32 M16 L43 Z02-H | ✓ | 118 € | |
| SM43510 | MT90 XNKT08 D40 M16 L43 Z04-H | ✓ | 125 € | |



| Ordering Code | Item Designation | | Price | Master Insert* |
|-------------------------|----------------------------|---|-------------|----------------|
| <i>TK90 XNKT 0805..</i> | | | <i>EURO</i> | |
| SM27961 | TK90 XNKT08 D40 A16 Z04-H | ✓ | 93 € | XNKT 08.. |
| SM24472 | TK90 XNKT08 D50 A22 Z05-H | ✓ | 112 € | |
| SM24489 | TK90 XNKT08 D63 A22 Z06-H | ✓ | 131 € | |
| SM24496 | TK90 XNKT08 D80 A27 Z08-H | ✓ | 153 € | |
| SM27930 | TK90 XNKT08 D100 A32 Z08-H | ✓ | 185 € | |
| SM38929 | TK90 XNKT08 D100 A32 Z09-H | ✓ | 185 € | |
| SM38516 | TK90 XNKT08 D125 B40 Z10 | - | 246 € | |

Cooling mounting screw is optional / See Page 294 for cooling mounting screws.
İçten su vermeli montaj vidaları opsiyoneldir. / Bkz. Sayfa 294 İçten su vermeli montaj vidaları için.

| Size Designation | Master Insert* | Spare Parts | | |
|------------------|----------------|-------------------------|----------------------|------------------------|
| | | Screw | Torx Key | Screw Torque Value |
| D20 - D25 | XNKT 0604.. | SSV M3x6- 9507 | STK-T08- 9908 | 1,9 |
| D32 - D40 | | SSV M3x8- 9508 | | |
| D30 - D125 | XNKT 0805 | SSV M4x9x5- 9528 | STK-T15- 9910 | 4,3 |

*Suitable Insert brand is KRLY.



| Ordering Code | Item Designation | | Price | Master Insert* |
|--------------------------------------|-------------------------------|---|-------------|----------------|
| ST90 3PKT 0603.. / 1004.. | | | <i>EURO</i> | |
| SM36802 | ST90 3PK06 D12 W12 L120 Z01-H | ✓ | 103 € | 3PKT 0603.. |
| SM36826 | ST90 3PK06 D16 W16 L150 Z03-H | ✓ | 106 € | |
| SM36840 | ST90 3PK06 D20 W20 L150 Z04-H | ✓ | 115 € | |
| SM36864 | ST90 3PK10 D16 W16 L150 Z01-H | ✓ | 106 € | 3PKT 1004.. |
| SM00845 | ST90 3PK10 D17 W16 L150 Z01-H | ✓ | 123 € | |
| SM36871 | ST90 3PK10 D20 W20 L150 Z02-H | ✓ | 115 € | |
| SM00852 | ST90 3PK10 D21 W20 L150 Z02-H | ✓ | 127 € | |
| SM00883 | ST90 3PK10 D21 C20 L200 Z02 | - | 165 € | |
| SM01699 | ST90 3PK10 D22 W20 L120 Z02-H | ✓ | 125 € | |
| SM53946 | ST90 3PK10 D22 W20 L150 Z02-H | ✓ | 124 € | |
| SM36888 | ST90 3PK10 D25 W25 L150 Z03-H | ✓ | 122 € | |
| SM00869 | ST90 3PK10 D26 W25 L150 Z03-H | ✓ | 134 € | |
| SM00890 | ST90 3PK10 D26 C25 L200 Z03 | - | 178 € | |
| SM36895 | ST90 3PK10 D32 W32 L150 Z04-H | ✓ | 129 € | |



| Ordering Code | Item Designation | | Price | Master Insert* |
|--------------------------------------|------------------------------|---|-------------|----------------|
| MT90 3PKT 0603.. / 1004.. | | | <i>EURO</i> | |
| SM53953 | MT90 3PK10 D20 M10 L30 Z02-H | ✓ | 111 € | 3PKT 1004.. |
| SM01705 | MT90 3PK10 D25 M12 L35 Z03-H | ✓ | 119 € | |
| SM01378 | MT90 3PK10 D32 M16 L43 Z04-H | ✓ | 125 € | |
| SM53960 | MT90 3PK10 D35 M16 L43 Z05-H | ✓ | 125 € | |
| SM53977 | MT90 3PK10 D40 M16 L43 Z05-H | ✓ | 125 € | |



| Ordering Code | Item Designation | | Price | Master Insert* |
|--------------------------------------|----------------------------|---|-------------|----------------|
| TK90 3PKT 1004.. / 1505.. | | | <i>EURO</i> | |
| SM48997 | TK90 3PKT10 D40 A16 Z05-H | ✓ | 113 € | 3PKT 1004.. |
| SM49000 | TK90 3PKT10 D50 A22 Z06-H | ✓ | 136 € | |
| SM49017 | TK90 3PKT10 D63 A22 Z07-H | ✓ | 148 € | |
| SM00593 | TK90 3PKT15 D40 A16 Z04-H | ✓ | 95 € | 3PKT 1505.. |
| SM32163 | TK90 3PKT15 D50 A22 Z05-H | ✓ | 106 € | |
| SM32187 | TK90 3PKT15 D63 A22 Z06-H | ✓ | 128 € | |
| SM32200 | TK90 3PKT15 D80 A27 Z08-H | ✓ | 156 € | |
| SM40496 | TK90 3PKT15 D100 A32 Z09-H | ✓ | 218 € | |
| SM40502 | TK90 3PKT15 D125 B40 Z12 | - | 330 € | |

Cooling mounting screw is optional / See Page 294 for cooling mounting screws.
İçten su vermeli montaj vidaları opsiyoneldir. / Bkz. Sayfa 294 İçten su vermeli montaj vidaları için.

| Size Designation | Master Insert* | Spare Parts | | |
|------------------|----------------|------------------------|----------------------|--------------------|
| | | Screw | Torx Key | Screw Torque Value |
| D12 - D20 | | | | N·m |
| D12 - D20 | 3PKT 0603.. | SSV M2x5- 9502 | STK-T06- 9906 | 0,6 |
| D16 - D63 | 3PKT 1004.. | SSV M3x6- 9507 | STK-T08- 9908 | 1,9 |
| D40 - D125 | 3PKT 1505.. | SSV M4x10- 9514 | STK-T15- 9910 | 4,3 |

*Suitable Insert brand is KRLY.



| Ordering Code | Item Designation | | Price | Master Insert* |
|---------------|--------------------------------|---|-------|----------------|
| | <i>ST90 TN.X 1005..</i> | | EURO | |
| SM47181 | ST90 TN1005 D20 W20 L150 Z02-H | ✓ | 115 € | TN.X 1005.. |
| SM47198 | ST90 TN1005 D25 W25 L150 Z03-H | ✓ | 124 € | |
| SM47204 | ST90 TN1005 D32 W32 L150 Z04-H | ✓ | 131 € | |



| Ordering Code | Item Designation | | Price | Master Insert* |
|---------------|-------------------------------|---|-------|----------------|
| | <i>MT90 TN.X 1005..</i> | | EURO | |
| SM47211 | MT90 TN1005 D20 M10 L30 Z02-H | ✓ | 104 € | TN.X 1005.. |
| SM47228 | MT90 TN1005 D25 M12 L35 Z03-H | ✓ | 110 € | |
| SM47235 | MT90 TN1005 D32 M16 L43 Z04-H | ✓ | 115 € | |



| Ordering Code | Item Designation | | Price | Master Insert* |
|---------------|---------------------------|---|-------|----------------|
| | <i>TK90 TN.X 1005..</i> | | EURO | |
| SM47150 | TK90 TN1005 D40 A16 Z05-H | ✓ | 113 € | TN.X 1005.. |
| SM47167 | TK90 TN1005 D50 A22 Z06-H | ✓ | 136 € | |
| SM47174 | TK90 TN1005 D63 A22 Z07-H | ✓ | 148 € | |

Cooling mounting screw is optional / See Page 294 for cooling mounting screws.
İçten su vermeli montaj vidaları opsiyoneldir. / Bkz. Sayfa 294 İçten su vermeli montaj vidaları için.

| Size Designation | Master Insert* | Spare Parts | | |
|------------------|----------------|-------------------------|------------------|--------------------|
| | | Screw | Torx Key | Screw Torque Value |
| D20 - D63 | TN.X 1005.. | SSV M3x6 LG-9509 | STK-T08-9908 | N·m 1,9 |

**Body corners should be modified for R2 and more radius inserts / R2 ve üstü radyüslü uçlarda takımın modifiye edilmesi gerekmektedir.

*Suitable Insert brand is ISC.



| Ordering Code | Item Designation | | Price | Master Insert* |
|---------------|--------------------------------|---|-------|----------------|
| | <i>ST90 TNGX 1004..</i> | | EURO | |
| SM46733 | ST90 TNGX10 D20 W20 L150 Z03-H | ✓ | 115 € | TNGX 1004.. |
| SM46740 | ST90 TNGX10 D25 W25 L150 Z04-H | ✓ | 124 € | |
| SM46757 | ST90 TNGX10 D32 W32 L150 Z04-H | ✓ | 131 € | |



| Ordering Code | Item Designation | | Price | Master Insert* |
|---------------|---------------------------|---|-------|----------------|
| | <i>TK90 TNGX 1004..</i> | | EURO | |
| SM46160 | TK90 TNGX10 D40 A16 Z04-H | ✓ | 113 € | TNGX 1004.. |
| SM46177 | TK90 TNGX10 D50 A22 Z05-H | ✓ | 136 € | |
| SM46184 | TK90 TNGX10 D63 A22 Z06-H | ✓ | 148 € | |

| Size Designation | Master Insert* | Spare Parts | | |
|------------------|----------------|--|------------------|--------------------|
| | | Screw | Torx Key | Screw Torque Value |
| D20 D25 - D63 | TNGX 1004.. | SSV M2.5x6-9505 SSV M2.5x7-9506 | STK-T08-9908 | N·m 1,2 |

*Suitable Insert brand is PRMT.



| Ordering Code | Item Designation | | Price | Master Insert* |
|---------------|------------------------------|---|-------|----------------|
| | <i>ST90 TP.. 1003..</i> | | EURO | |
| SM47518 | ST90 TP10 D25 W25 L150 Z02-H | ✓ | 124 € | TP.. 1003..** |
| SM47525 | ST90 TP10 D28 W25 L150 Z03-H | ✓ | 137 € | |
| SM47532 | ST90 TP10 D32 W32 L150 Z04-H | ✓ | 144 € | |



| Ordering Code | Item Designation | | Price | Master Insert* |
|---------------|-----------------------------|---|-------|----------------|
| | <i>MT90 TP.. 1003..</i> | | EURO | |
| SM47600 | MT90 TP10 D25 M12 L35 Z02-H | ✓ | 110 € | TP.. 1003..** |
| SM47617 | MT90 TP10 D32 M16 L43 Z04-H | ✓ | 115 € | |



| Ordering Code | Item Designation | | Price | Master Insert* |
|---------------|-------------------------|---|-------|----------------|
| | <i>TK90 TP.. 1003..</i> | | EURO | |
| SM46634 | TK90 TP10 D40 A16 Z04-H | ✓ | 113 € | TP.. 1003..** |
| SM46641 | TK90 TP10 D50 A22 Z05-H | ✓ | 136 € | |
| SM46658 | TK90 TP10 D63 A22 Z06-H | ✓ | 148 € | |
| SM50020 | TK90 TP10 D80 A27 Z07-H | ✓ | 159 € | |

Cooling mounting screw is optional / See Page 294 for cooling mounting screws.
İçten su vermeli montaj vidaları opsiyoneldir. / Bkz. Sayfa 294 İçten su vermeli montaj vidaları için.

Milling Tools

| Size Designation | Master Insert* | Spare Parts | | |
|------------------|----------------|---------------------------|------------------|--------------------|
| | | Screw | Torx Key | Screw Torque Value |
| D25 - D32 | TP.. 1003.. | SSV M3.5x8 SC-9513 | STK-T10-9909 | N·m 2,9 |

**Body corners should be modified for R2 and more radius inserts / R2 ve üstü radyüslü uçlarda takımın modifiye edilmesi gerekmektedir.

*Suitable Insert brand is ISC.

90 MILLING TOOLS



| Ordering Code | Item Designation | | Price | Master Insert* |
|---------------|------------------------------|---|-------|----------------|
| | ST90 6NGU 0604.. | | EURO | |
| SM58620 | ST90 6N06 D25 W25 L150 Z02-H | ✓ | 124 € | 6NGU 0604.. |
| SM58637 | ST90 6N06 D32 W32 L150 Z03-H | ✓ | 131 € | |



| Ordering Code | Item Designation | | Price | Master Insert* |
|---------------|-----------------------------|---|-------|----------------|
| | MT90 6NGU 0604.. | | EURO | |
| SM58644 | MT90 6N06 D25 M12 L35 Z02-H | ✓ | 110 € | 6NGU 0604.. |
| SM58651 | MT90 6N06 D32 M16 L43 Z03-H | ✓ | 115 € | |



| Ordering Code | Item Designation | | Price | Master Insert* |
|---------------|-------------------------|---|-------|----------------|
| | TK90 6NGU 0905.. | | EURO | |
| SM56107 | TK90 6N09 D50 A22 Z04-H | ✓ | 123 € | 6NGU 0905.. |
| SM56114 | TK90 6N09 D63 A22 Z05-H | ✓ | 134 € | |
| SM56121 | TK90 6N09 D80 A27 Z07-H | ✓ | 157 € | |

Cooling mounting screw is optional / See Page 294 for cooling mounting screws.
İçten su vermeli montaj vidaları opsiyoneldir. / Bkz. Sayfa 294 İçten su vermeli montaj vidaları için.



| Ordering Code | Item Designation | | Price | Master Insert* |
|---------------|------------------------------|---|-------|----------------|
| | ST90 6NKU 0403.. | | EURO | |
| SM47488 | ST90 6N04 D20 W20 L150 Z02-H | ✓ | 116 € | 6NKU 0403.. |
| SM47495 | ST90 6N04 D25 W25 L150 Z03-H | ✓ | 129 € | |
| SM47501 | ST90 6N04 D32 W32 L150 Z04-H | ✓ | 137 € | |



| Ordering Code | Item Designation | | Price | Master Insert* |
|---------------|-----------------------------|---|-------|----------------|
| | MT90 6NKU 0403.. | | EURO | |
| SM47570 | MT90 6N04 D20 M10 L30 Z02-H | ✓ | 90 € | 6NKU 0403.. |
| SM47587 | MT90 6N04 D25 M12 L35 Z03-H | ✓ | 95 € | |
| SM47594 | MT90 6N04 D32 M16 L43 Z04-H | ✓ | 104 € | |

| Size Designation | Master Insert* | Spare Parts | | |
|------------------|----------------|-----------------|----------|--------------------|
| | | Screw | Torx Key | Screw Torque Value |
| D20 | 6NKU 0403.. | | | N-m |
| D25 - D32 | | SSV M2.5x6-9505 | | |
| | | SSV M2.5x7-9506 | | |





| Ordering Code | Item Designation | | Price | Master Insert* |
|--------------------------|------------------------------|---|-------------|----------------|
| <i>ST90 TNMU 0703...</i> | | | <i>EURO</i> | |
| SM58019 | ST90 TN07 D16 W16 L150 Z02-H | ✓ | 115 € | TNMU 0703.. |
| SM58026 | ST90 TN07 D18 W16 L150 Z02-H | ✓ | 115 € | |
| SM58033 | ST90 TN07 D20 W20 L150 Z02-H | ✓ | 124 € | |
| SM58040 | ST90 TN07 D22 W20 L150 Z02-H | ✓ | 124 € | |
| SM58057 | ST90 TN07 D25 W25 L150 Z03-H | ✓ | 134 € | |
| SM58064 | ST90 TN07 D26 W25 L150 Z04-H | ✓ | 134 € | |
| SM58071 | ST90 TN07 D32 W32 L150 Z04-H | ✓ | 143 € | |
| SM58088 | ST90 TN07 D33 W32 L150 Z05-H | ✓ | 143 € | |



| Ordering Code | Item Designation | | Price | Master Insert* |
|--------------------------|-------------------------|---|-------------|----------------|
| <i>TK90 TNMU 0703...</i> | | | <i>EURO</i> | |
| SM57982 | TK90 TN07 D40 A16 Z06-H | ✓ | 127 € | TNMU 0703.. |
| SM57999 | TK90 TN07 D50 A22 Z08-H | ✓ | 165 € | |
| SM58002 | TK90 TN07 D63 A22 Z10-H | ✓ | 193 € | |

Cooling mounting screw is optional / See Page 294 for cooling mounting screws.
İçten su vermeli montaj vidaları opsiyoneldir. / Bkz. Sayfa 294 İçten su vermeli montaj vidaları için.

*Suitable Insert brand is TGTC.

| Size Designation | Master Insert* | Spare Parts | | |
|------------------|----------------|------------------------|------------------|--------------------|
| | | Screw | Torx Key | Screw Torque Value |
| D16 - D63 | TNMU 0703.. | SSV M2.2x5-9503 | STK-T06-9906 | N-m 0,85 |



| Ordering Code | Item Designation | | Price | Master Insert* |
|-------------------------|--------------------------|---|-------------|----------------|
| <i>TK90 TNMX 1806..</i> | | | <i>EURO</i> | |
| SM46986 | TK90 TN18 D63 A22 Z05-H | ✓ | 125 € | TNMX 1806.. |
| SM46993 | TK90 TN18 D80 A27 Z06-H | ✓ | 148 € | |
| SM47006 | TK90 TN18 D100 A32 Z07-H | ✓ | 177 € | |

*Suitable Insert brand is TGTC.

| Size Designation | Master Insert* | Spare Parts | | |
|------------------|----------------|--------------------|------------------|--------------------|
| | | Screw | Torx Key | Screw Torque Value |
| D63 - D100 | TNMX 1806.. | SSV M4x12-9515 | STK-T15-9910 | N-m 4,3 |



| Ordering Code | Item Designation | | Price | Master Insert* |
|----------------------------------|------------------------------|---|-------------|----------------|
| <i>ST90 TOMT 0603.. / 1004..</i> | | | <i>EURO</i> | |
| SM46078 | ST90 TO06 D16 W16 L150 Z02-H | ✓ | 106 € | TOMT 0603.. |
| SM46085 | ST90 TO06 D20 W20 L150 Z03-H | ✓ | 115 € | |
| SM46092 | ST90 TO06 D25 W25 L150 Z04-H | ✓ | 124 € | |
| SM46108 | ST90 TO10 D25 W25 L150 Z02-H | ✓ | 124 € | TOMT 1004.. |
| SM46115 | ST90 TO10 D32 W32 L150 Z03-H | ✓ | 131 € | |



| Ordering Code | Item Designation | | Price | Master Insert* |
|----------------------------------|--------------------------|---|-------------|----------------|
| <i>TK90 TOMT 1004.. / 1506..</i> | | | <i>EURO</i> | |
| SM46023 | TK90 TO10 D40 A16 Z04-H | ✓ | 113 € | TOMT 1004.. |
| SM46030 | TK90 TO10 D50 A22 Z05-H | ✓ | 136 € | |
| SM46047 | TK90 TO10 D63 A22 Z06-H | ✓ | 148 € | |
| SM52949 | TK90 TO15 D50 A22 Z04-H | | 134 € | TOMT 1506.. |
| SM52956 | TK90 TO15 D63 A22 Z05-H | | 143 € | |
| SM52963 | TK90 TO15 D80 A27 Z06-H | | 154 € | |
| SM52970 | TK90 TO15 D100 A32 Z07-H | | 176 € | |
| SM52987 | TK90 TO15 D125 B40 Z08 | | 248 € | |

Cooling mounting screw is optional / See Page 294 for cooling mounting screws.
İçten su vermeli montaj vidaları opsiyoneldir. / Bkz. Sayfa 294 İçten su vermeli montaj vidaları için.

| Size Designation | Master Insert* | Spare Parts | | |
|------------------|----------------|--------------------|--------------|--------------------|
| | | Screw | Torx Key | Screw Torque Value |
| D16 - D25 | TOMT 0603.. | | | N·m |
| D25 - D63 | TOMT 1004.. | SSV M2.5x5-9504 | STK-T08-9908 | 1,2 |
| D63 - D125 | TOMT 1506..** | SSV M3.5x8 SC-9513 | STK-T10-9909 | 2,9 |
| D125 - D160 | TOMT 1506..** | SSV M5x13-9519 | STK-T20-9911 | 8,5 |

**Body corners should be modified for R2 and more radius inserts / R2 ve üstü radyüslü uçlarda takımın modifiye edilmesi gerekmektedir.
*Suitable Insert brand is TNGLY.



| Ordering Code | Item Designation | | Price | Master Insert* |
|-------------------------|--------------------------|---|-------------|----------------|
| <i>TK90 WN.. 0806..</i> | | | <i>EURO</i> | |
| SM25288 | TK90 WN08 D50 A22 Z04-H | ✓ | 108 € | WN.. 0806.. |
| SM25295 | TK90 WN08 D63 A22 Z05-H | ✓ | 125 € | |
| SM25301 | TK90 WN08 D80 A27 Z07-H | ✓ | 148 € | |
| SM39612 | TK90 WN08 D100 A32 Z08-H | ✓ | 177 € | |
| SM32293 | TK90 WN08 D125 B40 Z10 | | 236 € | |
| SM60647 | TK90 WN08 D160 C40 Z12 | - | 392 € | |

| Size Designation | Master Insert* | Spare Parts | | |
|------------------|----------------|----------------|--------------|--------------------|
| | | Screw | Torx Key | Screw Torque Value |
| D50 - D160 | WN.. 0806.. | | | N·m |
| D50 - D160 | WN.. 0806.. | SSV M5x13-9519 | STK-T20-9911 | 8,5 |

*Suitable Insert brand is KYCR.



| Ordering Code | Item Designation | | Price | Master Insert* |
|-------------------------|------------------------------|---|-------|----------------|
| ST90 XNEX 0403.. | | | EURO | |
| SM43183 | ST90 XN04 D17 W16 L150 Z02-H | ✓ | 106 € | XNEX 0403.. |
| SM43190 | ST90 XN04 D20 W20 L150 Z03-H | ✓ | 115 € | |
| SM54028 | ST90 XN04 D21 W20 L150 Z03-H | ✓ | 118 € | |
| SM43206 | ST90 XN04 D25 W25 L150 Z04-H | ✓ | 124 € | |
| SM54035 | ST90 XN04 D26 W25 L150 Z04-H | ✓ | 129 € | |
| SM43213 | ST90 XN04 D32 W32 L150 Z05-H | ✓ | 131 € | |
| SM54042 | ST90 XN04 D33 W32 L150 Z05-H | ✓ | 134 € | |



| Ordering Code | Item Designation | | Price | Master Insert* |
|-------------------------|-----------------------------|---|-------|----------------|
| MT90 XNEX 0403.. | | | EURO | |
| SM43824 | MT90 XN04 D20 M10 L30 Z03-H | ✓ | 104 € | XNEX 0403.. |
| SM43831 | MT90 XN04 D25 M12 L35 Z04-H | ✓ | 110 € | |



| Ordering Code | Item Designation | | Price | Master Insert* |
|-------------------------|----------------------------|---|-------|----------------|
| TK90 XNEX 0806.. | | | EURO | |
| SM28524 | TK90 XNEX08 D50 A22 Z04-H | ✓ | 108 € | XNEX 0806.. |
| SM28517 | TK90 XNEX08 D63 A22 Z05-H | ✓ | 125 € | |
| SM28500 | TK90 XNEX08 D80 A27 Z07-H | ✓ | 148 € | |
| SM32309 | TK90 XNEX08 D100 A32 Z08-H | ✓ | 177 € | |
| SM32316 | TK90 XNEX08 D125 B40 Z10 | - | 236 € | |

Cooling mounting screw is optional / See Page 294 for cooling mounting screws.
İçten su vermeli montaj vidaları opsiyoneldir. / Bkz. Sayfa 294 İçten su vermeli montaj vidaları için.

*Suitable Insert brand is SCO.

| Size Designation | Master Insert* | Spare Parts | | |
|------------------|----------------|----------------------------|----------------------|--------------------|
| | | Screw | Torx Key | Screw Torque Value |
| D17 - D21 | | | | |
| D25 - D33 | | SSV M2.5x5- 9504 | STK-T08- 9908 | 1,2 |
| D50 - D125 | XNEX 0806.. | SSV M2.5x6- 9505 | STK-T15- 9910 | 4,3 |



| Ordering Code | Item Designation | | Price | Master Insert* |
|---------------|----------------------------|---|-------|----------------|
| | TK90 WNGX 0806.. | | EURO | |
| SM43619 | TK90 WNGX08 D50 A22 Z04-H | ✓ | 112 € | WNGX 0806.. |
| SM43626 | TK90 WNGX08 D63 A22 Z05-H | ✓ | 131 € | |
| SM43633 | TK90 WNGX08 D80 A27 Z06-H | ✓ | 155 € | |
| SM43640 | TK90 WNGX08 D100 A32 Z08-H | ✓ | 186 € | |

Cooling mounting screw is optional / See Page 294 for cooling mounting screws.
İçten su vermeli montaj vidaları opsiyoneldir. / Bkz. Sayfa 294 İçten su vermeli montaj vidaları için.

*Suitable Insert brand is KRLY.

| Size Designation | Master Insert* | Spare Parts | | |
|------------------|----------------|-----------------------|------------------|--------------------|
| | | Screw | Torx Key | Screw Torque Value |
| D50 - D100 | WNGX.. 0806.. | SSV M5x13-9519 | STK-T20-9911 | N-m 8,5 |



| Ordering Code | Item Designation | | Price | Master Insert* |
|---------------|----------------------------|---|-------|----------------|
| | TK90 WNHU 0806.. | | EURO | |
| SM43572 | TK90 WNHU08 D50 A22 Z04-H | ✓ | 112 € | WNHU 0806.. |
| SM43589 | TK90 WNHU08 D63 A22 Z05-H | ✓ | 133 € | |
| SM43596 | TK90 WNHU08 D80 A27 Z06-H | ✓ | 155 € | |
| SM43602 | TK90 WNHU08 D100 A32 Z08-H | ✓ | 186 € | |

Cooling mounting screw is optional / See Page 294 for cooling mounting screws.
İçten su vermeli montaj vidaları opsiyoneldir. / Bkz. Sayfa 294 İçten su vermeli montaj vidaları için.

*Suitable Insert brand is ZCC-CT.

| Size Designation | Master Insert* | Spare Parts | | |
|------------------|----------------|-------------------------|------------------|--------------------|
| | | Screw | Torx Key | Screw Torque Value |
| D50 - D100 | WNHU.. 0806.. | SSV M4x12x5-9529 | STK-T15-9910 | N-m 4,3 |



| Ordering Code | Item Designation | | Price | Master Insert* |
|---------------|--------------------------|---|-------|----------------|
| | TK90 WN.U 0705.. | | EURO | |
| SM53427 | TK90 WN07 D50 A22 Z04-H | ✓ | 134 € | WN.U 0705.. |
| SM53434 | TK90 WN07 D63 A22 Z05-H | ✓ | 140 € | |
| SM53441 | TK90 WN07 D80 A27 Z07-H | ✓ | 176 € | |
| SM53458 | TK90 WN07 D100 A32 Z08-H | ✓ | 196 € | |

Cooling mounting screw is optional / See Page 294 for cooling mounting screws.
İçten su vermeli montaj vidaları opsiyoneldir. / Bkz. Sayfa 294 İçten su vermeli montaj vidaları için.

*Suitable Insert brand is ISC.

| Size Designation | Master Insert* | Spare Parts | | |
|------------------|----------------|-----------------------|------------------|--------------------|
| | | Screw | Torx Key | Screw Torque Value |
| D50 - D100 | WN.U.. 0705.. | SSV M4x12-9515 | STK-T15-9910 | N-m 4,3 |





| Ordering Code | Item Designation | | Price | Master Insert* |
|---------------|--|---|-------|--|
| | TK90 TPKN 1603.. / 2204.. ISO | | EURO | |
| SM32767 | TK90P TP16 D50 A22 Z04 | - | 118 € | TPKN 1603.. SUITABLE ISO INSERT |
| SM32774 | TK90P TP16 D63 A22 Z06 | - | 131 € | |
| SM32781 | TK90P TP16 D80 A27 Z07 | - | 158 € | |
| SM32798 | TK90P TP16 D100 A32 Z08 | - | 190 € | |
| SM32804 | TK90P TP16 D125 B40 Z09 | - | 260 € | |
| SM32811 | TK90P TP22 D63 A22 Z05 | - | 131 € | TPKN 2204.. SUITABLE ISO INSERT |
| SM32828 | TK90P TP22 D80 A27 Z06 | - | 158 € | |
| SM32835 | TK90P TP22 D100 A32 Z07 | - | 190 € | |
| SM32842 | TK90P TP22 D125 B40 Z08 | - | 260 € | |
| SM32859 | TK90P TP22 D160 C40 Z09 | - | 331 € | |
| SM32866 | TK90P TP22 D200 C60 Z12 | - | 466 € | |
| SM32880 | TK90P TP22 D315 D60 Z18 | - | 920 € | |

*Suitable Insert brand is ISO.

| Size Designation | Master Insert* | Spare Parts | | |
|------------------|----------------|--------------|-------------------------|--------------|
| | | Clamp Part | Screw | Allen Key |
| D50 - D125 | TPKN.. 1603.. | | | |
| D63 - D315 | TPKN. 2204.. | TKBP 9116 | TKSV M8x1x18 9227 | SAK-AA5-9904 |

Milling Tools



| Ordering Code | Item Designation | | Price | Master Insert* |
|---------------|--|---|-------|--|
| | TK75 APKT 1003.. / 1604.. ISO | | EURO | |
| SM28913 | TK75 AP10 D63 A22 Z05-H | ✓ | 102 € | APKT 1003.. SUITABLE ISO INSERT |
| SM28906 | TK75 AP10 D80 A27 Z06-H | ✓ | 118 € | |
| SM28890 | TK75 AP10 D100 A32 Z07-H | ✓ | 140 € | |
| SM14626 | TK75 AP16 D63 A22 Z05-H | ✓ | 102 € | APKT 1604.. SUITABLE ISO INSERT |
| SM28876 | TK75 AP16 D80 A27 Z06-H | ✓ | 118 € | |
| SM28869 | TK75 AP16 D100 A32 Z07-H | ✓ | 140 € | |
| SM38431 | TK75 AP16 D125 B40 Z08 | - | 213 € | |

*Suitable Insert brand is ISO.

| Size Designation | Master Insert* | Spare Parts | | |
|------------------|----------------|--------------------|--------------|--------------------|
| | | Screw | Torx Key | Screw Torque Value |
| D63 - D100 | APKT 1003.. | | | 1,2 |
| D63 - D125 | APKT 1604.. | SSV M4x9x5-9528 | STK-T15-9910 | 4,3 |

Cooling mounting screw is optional / See Page 294 for cooling mounting screws.
İçten su vermeli montaj vidaları opsiyoneldir. / Bkz. Sayfa 294 İçten su vermeli montaj vidaları için.



| Ordering Code | Item Designation | | Price | Master Insert* |
|-------------------------|---------------------------|---|-------------|----------------|
| <i>TK90 SEMT 1304..</i> | | | <i>EURO</i> | |
| SM55247 | TK90 SE1304 D50 A22 Z04-H | ✓ | 132 € | SEMT 1304.. |
| SM55254 | TK90 SE1304 D63 A22 Z05-H | ✓ | 143 € | |
| SM55261 | TK90 SE1304 D80 A27 Z06-H | ✓ | 154 € | |

*Suitable Insert brand is TGTC.

| Size Designation | Master Insert* | Spare Parts | | |
|------------------|----------------|------------------------|------------------|--------------------|
| | | Screw | Torx Key | Screw Torque Value |
| D50 - D80 | SEMT 1304.. | SSV M4x9x5-9528 | STK-T15-9910 | N-m 4,3 |



| Ordering Code | Item Designation | | Price | Master Insert* |
|----------------------------------|-----------------------------|---|-------------|----------------|
| <i>TK90 R290.12.. / SE..12T3</i> | | | <i>EURO</i> | |
| SM29026 | TK90 R290.12 D50 A22 Z04-H | ✓ | 82 € | R290.12.. |
| SM29019 | TK90 R290.12 D63 A22 Z05-H | ✓ | 100 € | |
| SM29002 | TK90 R290.12 D80 A27 Z07-H | ✓ | 118 € | |
| SM28999 | TK90 R290.12 D100 A32 Z09-H | ✓ | 168 € | |
| SM14213 | TK90 R290.12 D125 B40 Z11 | - | 230 € | |

*Suitable Insert brand is ZCC-CT / SNDV.

| Size Designation | Master Insert* | Spare Parts | | |
|------------------|-------------------------|-------------------------|------------------|--------------------|
| | | Screw | Torx Key | Screw Torque Value |
| D50 - D125 | R290.12.. SE..12T3.. | SSV M3.5x10-9511 | STK-T15-9910 | N-m 2,9 |



| Ordering Code | Item Designation | | Price | Master Insert* |
|-------------------------|-------------------------|---|-------------|----------------|
| <i>TK90 SOMT 12T3..</i> | | | <i>EURO</i> | |
| SM32224 | TK90 SO12 D50 A22 Z04-H | ✓ | 82 € | SOMT 12T3.. |
| SM32248 | TK90 SO12 D63 A22 Z05-H | ✓ | 100 € | |
| SM32262 | TK90 SO12 D80 A27 Z07-H | ✓ | 118 € | |

*Suitable Insert brand is MTSBH.

| Size Designation | Master Insert** | Spare Parts | | |
|------------------|-----------------|------------------------|------------------|--------------------|
| | | Screw | Torx Key | Screw Torque Value |
| D50 - D80 | SOMT 12T3.. | SSV M4x9x5-9528 | STK-T15-9910 | N-m 4,3 |

Cooling mounting screw is optional / See Page 294 for cooling mounting screws.
İçten su vermeli montaj vidaları opsiyoneldir. / Bkz. Sayfa 294 İçten su vermeli montaj vidaları için.



| Ordering Code | Item Designation | | Price | Master Insert* |
|---------------|--------------------------------|---|-------|----------------|
| | <i>ST90 SDMT 09T3..</i> | | EURO | |
| SM56084 | ST90 SD09T3 D25 W25 L150 Z02-H | ✓ | 96 € | SDMT 09T3.. |
| SM56169 | ST90 SD09T3 D26 W25 L150 Z02-H | ✓ | 96 € | |
| SM56305 | ST90 SD09T3 D32 W32 L150 Z03-H | ✓ | 105 € | |
| SM56312 | ST90 SD09T3 D33 W32 L150 Z03-H | ✓ | 105 € | |



| Ordering Code | Item Designation | | Price | Master Insert* |
|---------------|-------------------------------|---|-------|----------------|
| | <i>MT90 SDMT 09T3..</i> | | EURO | |
| SM56534 | MT90 SD09T3 D25 M12 L35 Z02-H | ✓ | 110 € | SDMT 09T3.. |
| SM56541 | MT90 SD09T3 D32 M16 L43 Z03-H | ✓ | 121 € | |



| Ordering Code | Item Designation | | Price | Master Insert* |
|---------------|-------------------------------|---|-------|----------------|
| | <i>MT45 SDMT 09T3..</i> | | EURO | |
| SM56503 | MT45 SD09T3 D20 M10 L30 Z02-H | ✓ | 110 € | SDMT 09T3.. |
| SM56510 | MT45 SD09T3 D25 M12 L35 Z03-H | ✓ | 121 € | |
| SM56527 | MT45 SD09T3 D32 M16 L43 Z03-H | ✓ | 127 € | |



| Ordering Code | Item Designation | | Price | Master Insert* |
|---------------|---------------------------|---|-------|----------------|
| | <i>TK90 SDMT 09T3..</i> | | EURO | |
| SM53472 | TK90 SD09T3 D40 A16 Z04-H | ✓ | 110 € | SDMT 09T3.. |
| SM53489 | TK90 SD09T3 D50 A22 Z05-H | ✓ | 121 € | |
| SM53496 | TK90 SD09T3 D63 A22 Z06-H | ✓ | 143 € | |

*Suitable Insert brand is WLTR.

| Size Designation | Master Insert* | Spare Parts | | |
|------------------|----------------|---------------------------|------------------|--------------------|
| | | Screw | Torx Key | Screw Torque Value |
| D25 - D63 | SDMT 09T3.. | SSV M3.5x8-SC-9513 | STK-T10-9909 | N-m 2,9 |

Cooling mounting screw is optional / See Page 294 for cooling mounting screws.
İçten su vermeli montaj vidaları opsiyoneldir. / Bkz. Sayfa 294 içten su vermeli montaj vidaları için.



| Ordering Code | Item Designation | | Price | Master Insert* |
|-----------------------|---------------------------------|---|-------------|----------------|
| <i>ST90 490R-08..</i> | | | <i>EURO</i> | |
| SM56640 | ST90 490R-08 D20 W20 L150 Z02-H | ✓ | 99 € | 490R-08.. |
| SM56657 | ST90 490R-08 D25 W25 L150 Z03-H | ✓ | 103 € | |
| SM56664 | ST90 490R-08 D26 W25 L150 Z03-H | ✓ | 103 € | |
| SM56671 | ST90 490R-08 D32 W32 L150 Z04-H | ✓ | 135 € | |
| SM56688 | ST90 490R-08 D33 W32 L150 Z04-H | ✓ | 138 € | |



| Ordering Code | Item Designation | | Price | Master Insert* |
|-----------------------|--------------------------------|---|-------------|----------------|
| <i>ST90 490R-08..</i> | | | <i>EURO</i> | |
| SM56695 | MT90 490R-08 D20 M10 L30 Z02-H | ✓ | 94 € | 490R-08.. |
| SM56701 | MT90 490R-08 D25 M12 L35 Z03-H | ✓ | 110 € | |
| SM56718 | MT90 490R-08 D32 M16 L43 Z04-H | ✓ | 127 € | |



| Ordering Code | Item Designation | | Price | Master Insert* |
|--------------------------------|----------------------------|---|-------------|----------------|
| <i>TK90 490-08.. / 490R-14</i> | | | <i>EURO</i> | |
| SM50303 | TK90 490R-08 D40 A16 Z04-H | ✓ | 102 € | 490R-08.. |
| SM50310 | TK90 490R-08 D50 A22 Z05-H | ✓ | 118 € | |
| SM50327 | TK90 490R-08 D63 A22 Z06-H | ✓ | 140 € | |
| SM32101 | TK90 490R-14 D50 A22 Z04-H | ✓ | 102 € | 490R-14.. |
| SM32118 | TK90 490R-14 D63 A22 Z05-H | ✓ | 118 € | |
| SM32132 | TK90 490R-14 D80 A27 Z07-H | ✓ | 151 € | |
| SM58484 | TK90 490R-14 D80 A27 Z08-H | ✓ | 162 € | |

*Suitable Insert brand is SNDV.

| Size Designation | Master Insert* | Spare Parts | | |
|------------------|----------------|-------------------------|------------------|--------------------|
| | | Screw | Torx Key | Screw Torque Value |
| D20 - D63 | | SSV M2.5x7-9506 | STK-T08-9908 | 1,2 |
| D50 - D80 | | SSV M3.5x10-9511 | STK-T15-9910 | 2,9 |

Cooling mounting screw is optional / See Page 294 for cooling mounting screws.
İçten su vermeli montaj vidaları opsiyoneldir. / Bkz. Sayfa 294 İçten su vermeli montaj vidaları için.

**Body corners should be modified for R2 and more radius inserts / R2 ve üstü radyüslü uçlarda takımın modifiye edilmesi gerekmektedir.



| Ordering Code | Item Designation | | Price | Master Insert* |
|---------------|--------------------------------|---|-------|----------------|
| | <i>ST90 SD.T 09M4..</i> | | EURO | |
| SM59054 | ST90 SD09M4 D25 W25 L150 Z02-H | ✓ | 97 € | SD.T 09M4.. |
| SM59061 | ST90 SD09M4 D32 W32 L150 Z03-H | ✓ | 105 € | |
| SM59078 | ST90 SD09M4 D35 W32 L150 Z03-H | ✓ | 113 € | |



| Ordering Code | Item Designation | | Price | Master Insert* |
|---------------|----------------------------------|---|-------|----------------|
| | <i>TK90 SD.T 09M4.. / 1305..</i> | | EURO | |
| SM54530 | TK90 SD09M4 D40 A16 Z04-H | ✓ | 102 € | SD.T 09M4.. |
| SM54547 | TK90 SD09M4 D50 A22 Z05-H | ✓ | 118 € | |
| SM54554 | TK90 SD09M4 D63 A22 Z06-H | ✓ | 140 € | |
| SM56855 | TK90 SD1305 D50 A22 Z04-H | ✓ | 102 € | SD.T 1305.. |
| SM56862 | TK90 SD1305 D63 A22 Z05-H | ✓ | 118 € | |
| SM56879 | TK90 SD1305 D80 A27 Z06-H | ✓ | 142 € | |
| SM56886 | TK90 SD1305 D100 A32 Z07-H | ✓ | 168 € | |

Cooling mounting screw is optional / See Page 294 for cooling mounting screws.
İçten su vermeli montaj vidaları opsiyoneldir. / Bkz. Sayfa 294 İçten su vermeli montaj vidaları için.

*Suitable Insert brand is KRLY.

| Size Designation | Master Insert* | Spare Parts | | |
|------------------|----------------|---------------------|--------------|--------------------|
| | | Screw | Torx Key | Screw Torque Value |
| | | | | N-m |
| D25 - D63 | SD.T 09M4.. | SSV M3.5x8-9510 | STK-T15-9910 | 2,9 |
| D50 - D100 | SD.T 1305.. | SSV M4.5x11-9518 | STK-T20-9911 | 5,0 |





| Ordering Code | Item Designation | | Price | Master Insert* |
|---------------|----------------------------|---|-------|----------------|
| | <i>TK90 SDMT 1506..</i> | | EURO | |
| SM00609 | TK90 SDMT15 D50 A22 Z04-H | ✓ | 132 € | SDMT 1506.. |
| SM00616 | TK90 SDMT15 D63 A22 Z05-H | ✓ | 143 € | |
| SM00623 | TK90 SDMT15 D80 A27 Z06-H | ✓ | 154 € | |
| SM00630 | TK90 SDMT15 D100 A32 Z08-H | ✓ | 176 € | |
| SM00647 | TK90 SDMT15 D125 B40 Z09 | - | 270 € | |

Cooling mounting screw is optional / See Page 294 for cooling mounting screws.
İçten su vermeli montaj vidaları opsiyoneldir. / Bkz. Sayfa 294 İçten su vermeli montaj vidaları için.







*Suitable Insert brand is WDA.

| Size Designation | Master Insert* | Spare Parts | | |
|------------------|----------------|---------------------|--------------|--------------------|
| | | Screw | Torx Key | Screw Torque Value |
| | | | | N-m |
| D50 - D125 | SDMT 1506.. | SSV M4.5x11 9518 | STK-T20-9911 | 5,0 |





| Ordering Code | Item Designation | | Price | Master Insert* |
|---------------|--|---|-------|---|
| | ST90 SPMG 0602.. / 07T3.. / 0904.. |  | EURO |  |
| SM36901 | ST90 SP06 D17 W16 L150 Z02 | - | 53 € | SPMG 060204 |
| SM36918 | ST90 SP06 D20 W20 L150 Z03 | - | 65 € | |
| SM36925 | ST90 SP07 D22 W20 L150 Z03 | - | 65 € | SPMG 07T308 |
| SM36949 | ST90 SP07 D25 W25 L150 Z03 | - | 71 € | |
| SM36956 | ST90 SP07 D26 W25 L150 Z03 | - | 71 € | |
| SM36970 | ST90 SP09 D32 W32 L150 Z03 | - | 77 € | SPMG 090408 |
| SM36987 | ST90 SP09 D33 W32 L150 Z03 | - | 80 € | |





*Suitable Insert brand is TGTC.

| Size Designation | Master Insert* | Spare Parts | | |
|------------------|---|---|---|--|
| |  | Screw | Torx Key | Screw Torque Value |
| D17 - D20 | SPMG 060204 |  SSV M2.2x5-9503 |  STK-T06-9906 |  N-m 0,6 |
| D22 - D25 | SPMG 07T308 |  SSV M2.5x6-9507 |  STK-T08-9908 | 1,2 |
| D32 - D33 | SPMG 090408 |  SSV M3.5x8-9510 |  STK-T15-9910 | 8,5 |



| Ordering Code | Item Designation | | Price | Master Insert* |
|---------------|---|---|-------|---|
| | HF45 SPMG 0904.. / 1104.. CHAMFERING TOOLS |  | EURO |  |
| SM15555 | HF45 SP09 D11-25 W20 L150 Z01 | - | 53 € | SPMG 0904.. |
| SM15562 | HF45 SP11 D24-38 W25 L150 Z02 | - | 62 € | SPMG 1104.. |
| SM15579 | HF45 SP11 D31-45 W32 L150 Z03 | - | 66 € | |

*Suitable Insert brand is TGTC.

| Size Designation | Master Insert* | Spare Parts | | |
|------------------|---|---|---|--|
| |  | Screw | Torx Key | Screw Torque Value |
| D11-25 | SPMG 0904.. |  SSV M3.5x10-9511 |  STK-T15-9910 |  N-m 2,9 |
| D24-38 - D31-45 | SPMG 1104 |  SSV M4x10-9514 | | 4,3 |

Milling Tools



| Ordering Code | Item Designation | | Price | Master Insert* |
|---------------|----------------------------|---|-------|----------------|
| | TK90 XEKT-MA 19M5.. | | EURO | |
| SM55346 | TK90 XE19 D40 A16 Z03-H | ✓ | 127 € | XEKT-MA 19M5.. |
| SM55353 | TK90 XE19 D50 A22 Z04-H | ✓ | 156 € | |
| SM55360 | TK90 XE19 D63 A22 Z05-H | ✓ | 169 € | |

Cooling mounting screw is optional / See Page 294 for cooling mounting screws.
İçten su vermeli montaj vidaları opsiyoneldir. / Bkz. Sayfa 294 İçten su vermeli montaj vidaları için.

*Suitable Insert brand is KRLY.

| Size Designation | Master Insert* | Spare Parts | | |
|------------------|----------------|--------------------|--------------|--------------------|
| | | Screw | Torx Key | Screw Torque Value |
| D40 - D63 | | | | |
| | | SSV M4x9x5-9528 | STK-T15-9910 | N·m 4,3 |

**Body corners should be modified for R0.4-3.2 and more radius inserts / R0.4-3.2 ve üstü radyüslü uçlarda takımın modifiye edilmesi gerekmektedir. ■



| Ordering Code | Item Designation | | Price | Master Insert* |
|---------------|--------------------------------------|---|-------|----------------|
| | TK90 VCGT 1604.. / 2205.. ISO | | EURO | |
| SM33849 | TK90 VC16 D40 A16 Z03-H | ✓ | 71 € | VCGT 1604.. |
| SM33863 | TK90 VC16 D50 A22 Z04-H | ✓ | 85 € | |
| SM33887 | TK90 VC16 D63 A22 Z05-H | ✓ | 110 € | |
| SM33900 | TK90 VC16 D80 A27 Z05-H | ✓ | 128 € | VCGT 2205.. |
| SM33924 | TK90 VC22 D50 A22 Z04-H | ✓ | 85 € | |
| SM33931 | TK90 VC22 D63 A22 Z05-H | ✓ | 110 € | |
| SM33979 | TK90 VC22 D80 A27 Z05-H | ✓ | 128 € | |

Cooling mounting screw is optional / See Page 294 for cooling mounting screws.
İçten su vermeli montaj vidaları opsiyoneldir. / Bkz. Sayfa 294 İçten su vermeli montaj vidaları için.

*Suitable Insert brand is ISO.

| Size Designation | Master Insert** | Spare Parts | | |
|------------------|-----------------|---------------------|--------------|--------------------|
| | | Screw | Torx Key | Screw Torque Value |
| D40 - D80 | | | | |
| | | SSV M3.5x10-9511 | STK-T15-9910 | N·m 2,9 |
| D50 - D80 | VCGT 2205.. | SSV M5x13-9519 | STK-T20-9911 | 8,5 |

**Body corners should be modified for R0.4-3.2 and more radius inserts / R0.4-3.2 ve üstü radyüslü uçlarda takımın modifiye edilmesi gerekmektedir. ■

*Suitable Insert brand is TGTC.

50-90-89 MILLING TOOLS



| Ordering Code | Item Designation | | Price | Master Insert* |
|---------------|--------------------------|---|-------|----------------|
| | TK50 SYHU 0704.. | | EURO | |
| SM46856 | TK50 SY07 D50 A22 Z05-H | ✓ | 112 € | SYHU 0704.. |
| SM46863 | TK50 SY07 D63 A22 Z06-H | ✓ | 138 € | |
| SM46870 | TK50 SY07 D80 A27 Z07-H | ✓ | 156 € | |
| SM46887 | TK50 SY07 D100 A32 Z08-H | ✓ | 175 € | |

Cooling mounting screw is optional / See Page 294 for cooling mounting screws.
İçten su vermeli montaj vidaları opsiyoneldir. / Bkz. Sayfa 294 İçten su vermeli montaj vidaları için.

*Suitable Insert brand is ISC.

| Size Designation | Master Insert* | Spare Parts | | |
|------------------|----------------|----------------|--------------|--------------------|
| | | Screw | Torx Key | Screw Torque Value |
| D50 - D100 | SYHU 0704.. | SSV M4x12-9515 | STK-T15-9910 | 4,3 N-m |



| Ordering Code | Item Designation | | Price | Master Insert* |
|---------------|----------------------------|---|-------|----------------|
| | TK90 SDMT 1205.. | | EURO | |
| SM47013 | TK90 SDMT12 D50 A22 Z04-H | ✓ | 90 € | SDMT 1205.. |
| SM47020 | TK90 SDMT12 D63 A22 Z05-H | ✓ | 109 € | |
| SM47037 | TK90 SDMT12 D80 A27 Z06-H | ✓ | 129 € | |
| SM47044 | TK90 SDMT12 D100 A32 Z08-H | ✓ | 162 € | |
| SM47051 | TK90 SDMT12 D125 B40 Z09 | - | 249 € | |

Cooling mounting screw is optional / See Page 294 for cooling mounting screws.
İçten su vermeli montaj vidaları opsiyoneldir. / Bkz. Sayfa 294 İçten su vermeli montaj vidaları için.

*Suitable Insert brand is PRMT.

| Size Designation | Master Insert* | Spare Parts | | |
|------------------|----------------|----------------|--------------|--------------------|
| | | Screw | Torx Key | Screw Torque Value |
| D50 - D125 | SDMT 1205.. | SSV M4x12-9515 | STK-T15-9910 | 4,3 N-m |



| Ordering Code | Item Designation | | Price | Master Insert** |
|---------------|---------------------------|---|-------|-----------------|
| | TK89 SN.. 1206.. | | EURO | |
| SM00562 | TK89 SN12 D50 A22 Z04-H | ✓ | 78 € | SN.. 1206.. |
| SM28593 | TK89 SN12 D63 A22 Z06-H | ✓ | 88 € | |
| SM49659 | TK89L SN12 D63 A22 Z06-H* | ✓ | 93 € | |
| SM28586 | TK89 SN12 D80 A27 Z07-H | ✓ | 114 € | |
| SM49666 | TK89L SN12 D80 A27 Z07-H* | ✓ | 119 € | |
| SM28579 | TK89 SN12 D100 A32 Z09-H | ✓ | 142 € | |
| SM14619 | TK89 SN12 D125 B40 Z10 | - | 218 € | |
| SM14602 | TK89 SN12 D160 C40 Z11 | - | 297 € | |
| SM25271 | TK89 SN12 D200 C60 Z14 | - | 498 € | |

| Size Designation | Master Insert** | Spare Parts | | |
|------------------|-----------------|----------------|--------------|--------------------|
| | | Screw*** | Torx Key | Screw Torque Value |
| D50 - D200 | SN.. 1206.. | SSV M4x12-9515 | STK-T15-9910 | 4,3 N-m |

*Left Side / Sol Yön

**Suitable Insert brand is ISO

***Use SSV M4x12x6-9517 screws for SNMX1205-WLTR brand inserts (Stock Code: SM29934)
SNMX1205-WLTR marka uçlar için SSV M4x12x6-9517 civata kullanınız (Stok Kodu: SM29934)



| Ordering Code | Item Designation | | Price | Master Insert* |
|---------------|----------------------------|---|-------|----------------|
| | TK88 SNMU 1305.. | | EURO | |
| SM53137 | TK88 SN1305 D50 A22 Z04-H | ✓ | 116 € | SNMU 1305.. |
| SM53144 | TK88 SN1305 D50 A22 Z05-H | ✓ | 121 € | |
| SM53151 | TK88 SN1305 D63 A22 Z05-H | ✓ | 145 € | |
| SM53168 | TK88 SN1305 D63 A22 Z06-H | ✓ | 154 € | |
| SM53175 | TK88 SN1305 D80 A27 Z07-H | ✓ | 171 € | |
| SM53182 | TK88 SN1305 D80 A27 Z09-H | ✓ | 209 € | |
| SM53199 | TK88 SN1305 D100 A32 Z09-H | ✓ | 198 € | |
| SM53205 | TK88 SN1305 D100 A32 Z11-H | ✓ | 233 € | |
| SM53212 | TK88 SN1305 D125 B40 Z11 | - | 314 € | |
| SM53229 | TK88 SN1305 D160 C40 Z13 | - | 413 € | |

Cooling mounting screw is optional / See Page 294 for cooling mounting screws.
İçten su vermeli montaj vidaları opsiyoneldir. / Bkz. Sayfa 294 İçten su vermeli montaj vidaları için.

*Suitable Insert brand is KYCR.

| Size Designation | Master Insert* | Spare Parts | | |
|------------------|----------------|-------------------------|------------------|--------------------|
| | | Screw | Torx Key | Screw Torque Value |
| D50 - D160 | SNMU 1305.. | SSV M4x12x5-9529 | STK-T15-9910 | N-m 4,3 |



Milling Tools



| Ordering Code | Item Designation | | Price | Master Insert* |
|---------------|-----------------------------|---|-------|---------------------|
| | TK89 SNMU 1305..PNTR | | EURO | |
| SM53359 | TK89 SN13 D50 A22 Z04-H | ✓ | 116 € | SNMU 1305.. PNTR |
| SM53366 | TK89 SN13 D50 A22 Z05-H | ✓ | 121 € | |
| SM53373 | TK89 SN13 D63 A22 Z05-H | ✓ | 145 € | |
| SM01668 | TK89 SN13 D63 A22 Z07-H | ✓ | 154 € | |
| SM53380 | TK89 SN13 D80 A27 Z07-H | ✓ | 171 € | |
| SM53397 | TK89 SN13 D80 A27 Z09-H | ✓ | 209 € | |
| SM53403 | TK89 SN13 D100 A32 Z09-H | ✓ | 198 € | |
| SM53410 | TK89 SN13 D125 B40 Z11 | - | 314 € | |

Cooling mounting screw is optional / See Page 294 for cooling mounting screws.
İçten su vermeli montaj vidaları opsiyoneldir. / Bkz. Sayfa 294 İçten su vermeli montaj vidaları için.

*Suitable Insert brand is ISC.

| Size Designation | Master Insert* | Spare Parts | | |
|------------------|----------------|-------------------------|------------------|--------------------|
| | | Screw | Torx Key | Screw Torque Value |
| D50 - D125 | SNMU 1305.. | SSV M4x12x6-9517 | STK-T15-9910 | N-m 4,3 |



| Ordering Code | Item Designation | | Price | Master Insert* |
|---------------|---------------------------|---|--------|----------------|
| | TK45 SN.. 1206.. | | EURO | |
| SM29071 | TK45 SN12 D50 A22 Z05-H | ✓ | 105 € | SN.. 1206.. |
| SM14824 | TK45 SN12 D50 A22 Z05 | - | 100 € | |
| SM49628 | TK45L SN12 D50 A22 Z05-H* | ✓ | 123 € | |
| SM29064 | TK45 SN12 D63 A22 Z07-H | ✓ | 129 € | |
| SM14831 | TK45 SN12 D63 A22 Z07 | - | 123 € | |
| SM49635 | TK45L SN12 D63 A22 Z07-H* | ✓ | 140 € | |
| SM29040 | TK45 SN12 D80 A27 Z08-H | ✓ | 146 € | |
| SM14848 | TK45 SN12 D80 A27 Z08 | - | 140 € | |
| SM49642 | TK45L SN12 D80 A27 Z08-H* | ✓ | 153 € | |
| SM29033 | TK45 SN12 D100 A32 Z10-H | ✓ | 163 € | |
| SM14855 | TK45 SN12 D100 A32 Z10 | - | 156 € | |
| SM14862 | TK45 SN12 D125 B40 Z11 | - | 280 € | |
| SM14879 | TK45 SN12 D160 C40 Z12 | - | 353 € | |
| SM25226 | TK45 SN12 D200 C60 Z14 | - | 504 € | |
| SM38424 | TK45 SN12 D315 D60 Z20 | - | 1086 € | |

Cooling mounting screw is optional / See Page 294 for cooling mounting screws.
İçten su vermeli montaj vidaları opsiyoneldir. / Bkz. Sayfa 294 İçten su vermeli montaj vidaları için.

*Suitable Insert brand is ISO.

| Size Designation | Master Insert** | Spare Parts | | |
|------------------|-----------------|-----------------------|------------------|--------------------|
| | | Screw *** | Torx Key | Screw Torque Value |
| D50 - D315 | SN.. 1206.. | SSV M4x12-9515 | STK-T15-9910 | N-m 4,3 |

*Left Side / Sol Yön

**Suitable Insert brand is ISO

***Use SSV M4x12x6-9517 screws for SNMX1205-WLTR brand inserts (Stock Code: SM29934)
SNMX1205-WLTR marka uçlar için SSV M4x12x6-9517 civata kullanınız (Stok Kodu: SM29934)



| Ordering Code | Item Designation | | Price | Master Insert* |
|---------------|------------------------------------|---|-------|-------------------------|
| | TK45 R245.12T3.. / SE..12T3 | | EURO | |
| SM28982 | TK45 SE12 D50 A22 Z04-H | ✓ | 82 € | R245.12T3.. SE..12T3 |
| SM28975 | TK45 SE12 D63 A22 Z05-H | ✓ | 103 € | |
| SM53106 | TK45 SE12 D63 A22 Z06-H | ✓ | 118 € | |
| SM28968 | TK45 SE12 D80 A27 Z06-H | ✓ | 122 € | |
| SM53113 | TK45 SE12 D80 A27 Z08-H | ✓ | 151 € | |
| SM40182 | TK45 SE12 D80 A27 Z09-H | ✓ | 168 € | |
| SM28951 | TK45 SE12 D100 A32 Z07-H | ✓ | 144 € | |
| SM14800 | TK45 SE12 D125 B40 Z08 | - | 196 € | |
| SM14817 | TK45 SE12 D160 C40 Z10 | - | 308 € | |

Cooling mounting screw is optional / See Page 294 for cooling mounting screws.
İçten su vermeli montaj vidaları opsiyoneldir. / Bkz. Sayfa 294 İçten su vermeli montaj vidaları için.

*Suitable Insert brand is ZCC-CT.

| Size Designation | Master Insert* * | Spare Parts | | |
|------------------|---------------------------|-------------------------|------------------|--------------------|
| | | Screw | Torx Key | Screw Torque Value |
| D50 - D160 | R245.12T3.. SE..12T3.. | SSV M3.5x10-9511 | STK-T15-9910 | N-m 2,9 |



| Ordering Code | Item Designation | | Price | Master Insert* |
|---------------|--------------------------|---|-------|----------------|
| | TK45 SNMU 1305.. | | EURO | |
| SM46665 | TK45 SN13 D50 A22 Z04-H | ✓ | 108 € | SNMU 1305.. |
| SM46672 | TK45 SN13 D63 A22 Z06-H | ✓ | 132 € | |
| SM46689 | TK45 SN13 D80 A27 Z07-H | ✓ | 149 € | |
| SM46696 | TK45 SN13 D100 A32 Z09-H | ✓ | 179 € | |

Cooling mounting screw is optional / See Page 294 for cooling mounting screws.
İçten su vermeli montaj vidaları opsiyoneldir. / Bkz. Sayfa 294 İçten su vermeli montaj vidaları için.

*Suitable Insert brand is ISC.

| Size Designation | Master Insert* | Spare Parts | | |
|------------------|----------------|---------------------|--------------|---------------------------|
| | | Screw | Torx Key | Screw Torque Value N-m |
| D50 - D100 | SNMU 1305.. | SSV M4x12x6-9517 | STK-T15-9910 | 4,3 |



| Ordering Code | Item Designation | | Price | Master Insert* |
|---------------|-------------------------|---|-------|----------------|
| | TK45 SEMT 13T3.. | | EURO | |
| SM45392 | TK45 SE13 D50 A22 Z04-H | ✓ | 90 € | SEMT 13T3.. |
| SM45408 | TK45 SE13 D63 A22 Z05-H | ✓ | 114 € | |
| SM50082 | TK45 SE13 D80 A27 Z06-H | ✓ | 134 € | |

Cooling mounting screw is optional / See Page 294 for cooling mounting screws.
İçten su vermeli montaj vidaları opsiyoneldir. / Bkz. Sayfa 294 İçten su vermeli montaj vidaları için.

*Suitable Insert brand is SMTM.

| Size Designation | Master Insert* | Spare Parts | | |
|------------------|----------------|---------------------|--------------|---------------------------|
| | | Screw | Torx Key | Screw Torque Value N-m |
| D50 - D80 | SEMT 13T3.. | SSV M4x12x5-9529 | STK-T15-9910 | 4,3 |



| Ordering Code | Item Designation | | Price | Master Insert* |
|---------------|-----------------------------|---|-------|----------------|
| | TK45 R345-13.. | | EURO | |
| SM46269 | TK45 R345-13 D50 A22 Z05-H | ✓ | 108 € | R345-13.. |
| SM46276 | TK45 R345-13 D63 A22 Z06-H | ✓ | 132 € | |
| SM46283 | TK45 R345-13 D80 A27 Z07-H | ✓ | 149 € | |
| SM46290 | TK45 R345-13 D100 A32 Z09-H | ✓ | 179 € | |

Cooling mounting screw is optional / See Page 294 for cooling mounting screws.
İçten su vermeli montaj vidaları opsiyoneldir. / Bkz. Sayfa 294 İçten su vermeli montaj vidaları için.

*Suitable Insert brand is SDVK.

| Size Designation | Master Insert* | Spare Parts | | |
|------------------|----------------|-------------------|--------------|---------------------------|
| | | Screw | Torx Key | Screw Torque Value N-m |
| D50 - D100 | R345-13.. | SSV M4x12-9515 | STK-T15-9910 | 4,3 |



| Ordering Code | Item Designation | | Price | Master Insert* |
|---------------|----------------------------|---|-------|----------------|
| | TK45 SNMT 1205.. | | EURO | |
| SM46498 | TK45 SNMT12 D50 A22 Z04-H | ✓ | 108 € | SNMT 1205.. |
| SM46504 | TK45 SNMT12 D63 A22 Z05-H | ✓ | 132 € | |
| SM46511 | TK45 SNMT12 D80 A32 Z06-H | ✓ | 149 € | |
| SM46528 | TK45 SNMT12 D100 A32 Z07-H | ✓ | 179 € | |
| SM46535 | TK45 SNMT12 D125 B40 Z08 | - | 318 € | |
| SM46542 | TK45 SNMT12 D160 C40 Z10 | - | 400 € | |

Cooling mounting screw is optional / See Page 294 for cooling mounting screws.
İçten su vermeli montaj vidaları opsiyoneldir. / Bkz. Sayfa 294 İçten su vermeli montaj vidaları için.

*Suitable Insert brand is PRMT.

| Size Designation | Master Insert* | Spare Parts | | |
|------------------|----------------|-------------------------|------------------|--------------------|
| | | Screw | Torx Key | Screw Torque Value |
| D50 - D160 | SNMT 1205.. | SSV M4x12x6-9517 | STK-T15-9910 | N-m 4,3 |



| Ordering Code | Item Designation | | Price | Master Insert* |
|---------------|----------------------------|---|-------|----------------|
| | TK45 SNEG 1205.. | | EURO | |
| SM54158 | TK45 SNEG12 D50 A22 Z05-H | ✓ | 116 € | SNEG 1205.. |
| SM54165 | TK45 SNEG12 D63 A22 Z06-H | ✓ | 143 € | |
| SM54172 | TK45 SNEG12 D80 A27 Z07-H | ✓ | 157 € | |
| SM54189 | TK45 SNEG12 D100 A32 Z09-H | ✓ | 176 € | |
| SM54196 | TK45 SNEG12 D125 B40 Z11 | - | 303 € | |
| SM54202 | TK45 SNEG12 D160 C40 Z12 | - | 352 € | |

Cooling mounting screw is optional / See Page 294 for cooling mounting screws.
İçten su vermeli montaj vidaları opsiyoneldir. / Bkz. Sayfa 294 İçten su vermeli montaj vidaları için.

*Suitable Insert brand is ZCC-CT.

| Size Designation | Master Insert* | Spare Parts | | |
|------------------|----------------|-------------------------|------------------|--------------------|
| | | Screw | Torx Key | Screw Torque Value |
| D50 - D160 | SNEG 1205.. | SSV M4x12x5-9529 | STK-T15-9910 | N-m 4,3 |



| Ordering Code | Item Designation | | Price | Master Insert* |
|---------------|---------------------------|---|-------|----------------|
| | TK45 SN.X 1306.. | | EURO | |
| SM54219 | TK45 SN1306 D50 A22 Z04-H | ✓ | 121 € | SN.X 1306.. |
| SM54226 | TK45 SN1306 D63 A22 Z05-H | ✓ | 143 € | |
| SM54233 | TK45 SN1306 D80 A27 Z06-H | ✓ | 165 € | |

Cooling mounting screw is optional / See Page 294 for cooling mounting screws.
İçten su vermeli montaj vidaları opsiyoneldir. / Bkz. Sayfa 294 İçten su vermeli montaj vidaları için.

*Suitable Insert brand is TGTC.

| Size Designation | Master Insert** | Spare Parts | | |
|------------------|-----------------|-----------------------|------------------|--------------------|
| | | Screw | Torx Key | Screw Torque Value |
| D50 - D80 | SN.X 1306.. | SSV M4x12-9515 | STK-T15-9910 | N-m 4,3 |



| Ordering Code | Item Designation | | Price | Master Insert* |
|---------------|--------------------------------|---|-------------|----------------|
| | <i>ST45 SEET 0903..</i> | | <i>EURO</i> | |
| SM59085 | ST45 SE0903 D25 W25 L150 Z02-H | ✓ | 97 € | SEET 0903.. |
| SM59092 | ST45 SE0903 D32 W32 L150 Z03-H | ✓ | 105 € | |
| SM59108 | ST45 SE0903 D35 W32 L150 Z03-H | ✓ | 112 € | |
| SM59115 | ST45 SE0903 D40 W32 L150 Z04-H | ✓ | 121 € | |



| Ordering Code | Item Designation | | Price | Master Insert* |
|---------------|------------------------------------|---|-------------|----------------|
| | <i>TK45 SEET 0903.. / SE..14M4</i> | | <i>EURO</i> | |
| SM54356 | TK45 SE0903 D40 A16 Z04-H | ✓ | 112 € | SEET 0903.. |
| SM54363 | TK45 SE0903 D50 A22 Z05-H | ✓ | 121 € | |
| SM54370 | TK45 SE0903 D63 A22 Z06-H | ✓ | 132 € | |
| SM54387 | TK45 SE0903 D80 A27 Z08-H | ✓ | 154 € | |
| SM53274 | TK45 SE14 D50 A22 Z04-H | ✓ | 121 € | SE.. 14M4.. |
| SM53281 | TK45 SE14 D63 A22 Z05-H | ✓ | 132 € | |
| SM53298 | TK45 SE14 D80 A27 Z06-H | ✓ | 154 € | |
| SM53304 | TK45 SE14 D100 A32 Z07-H | ✓ | 200 € | |
| SM53311 | TK45 SE14 D125 B40 Z08 | - | 352 € | |



Cooling mounting screw is optional / See Page 294 for cooling mounting screws.
İçten su vermeli montaj vidaları opsiyoneldir. / Bkz. Sayfa 294 İçten su vermeli montaj vidaları için.

*Suitable Insert brand is KRLY.



Milling Tools

| Size Designation | Master Insert* | Spare Parts | | |
|------------------|-----------------|-----------------------|------------------|--------------------|
| | | Screw | Torx Key | Screw Torque Value |
| D25 - D80 | SEET 0903.. | SSV M3x8-9508 | STK-T08-9908 | 1,9 |
| D50 - D125 | SE.. 14M4 | SSV M4x10-9514 | STK-T15-9910 | 4,3 |

| Ordering Code | Item Designation | | Price | Master Insert* |
|---------------|--|---|-------|---|
| | TK45 SNMU 1307.. /ONMU 0705../RNMU 1307.. (R) |  | EURO |  |
| SM00289 | TK45 SN1307 D63 A22 Z06-H | ✓ | 167 € | SNMU 1307.. |
| SM00290 | TK45 SN1307 D80 A27 Z08-H | ✓ | 198 € | |
| SM00291 | TK45 SN1307 D100 A32 Z08-H | ✓ | 231 € | |

Cooling mounting screw is optional / See Page 294 for cooling mounting screws.

İçten su vermeli montaj vidaları opsiyoneldir. / Bkz. Sayfa 294 İçten su vermeli montaj vidaları için.

*Suitable Insert brand is TNGLY.

| Size Designation | Master Insert* | Spare Parts | | |
|------------------|--|--|---|--|
| | | Screw | Torx Key | Screw Torque Value |
| D63 - D100 |  SNMU 1307.. ONMU 0705.. RNMU 1307.. |  SSV M4x12x5-9529 |  STK-T15-9910 |  N-m 4,3 |





| Ordering Code | Item Designation | | Price | Master Insert* |
|---------------|----------------------------|---|--------|----------------|
| | <i>TK75 SPKN 1203..ISO</i> | | EURO | |
| SM32675 | TK75 SP12 D50 A22 Z04 | - | 118 € | SPKN 1203.. |
| SM32682 | TK75 SP12 D63 A22 Z05 | - | 131 € | |
| SM32705 | TK75 SP12 D80 A27 Z06 | - | 167 € | |
| SM32729 | TK75 SP12 D100 A32 Z07 | - | 207 € | |
| SM32743 | TK75 SP12 D125 B40 Z08 | - | 306 € | |
| SM38547 | TK75 SP12 D160 C40 Z09 | - | 345 € | |
| SM32750 | TK75 SP12 D200 C60 Z12 | - | 518 € | |
| SM38530 | TK75 SP12 D315 D60 Z18 | - | 1093 € | |

*Suitable Insert brand is ISO.

| Size Designation | Master Insert* | Spare Parts | | |
|------------------|----------------|------------------|-----------------------------|------------------|
| | | Clamp Part | Screw | Allen Key |
| D50 - D315 | SPKN.. 1203.. | TKBP 9116 | TKSV M8x1x18 9227 | SAK-AA5-9904 |



| Ordering Code | Item Designation | | Price | Master Insert* |
|---------------|--------------------------|---|-------|----------------|
| | <i>TK88 SNGN 1204..</i> | | EURO | |
| SM53328 | TK88 SN1204 D63 A22 Z06 | - | 187 € | SNGN 1204.. |
| SM53335 | TK88 SN1204 D80 A27 Z07 | - | 248 € | |
| SM53342 | TK88 SN1204 D100 A32 Z08 | - | 270 € | |

*Suitable Insert brand is KYCR.

| Size Designation | Master Insert* | Spare Parts | | |
|------------------|----------------|------------------|-----------------------------|------------------|
| | | Clamp Part | Screw | Allen Key |
| D63 - D100 | SNGN 1204.. | TKBP 9116 | TKSV M8x1x18 9227 | SAK-AA5-9904 |



Milling Tools



| Ordering Code | Item Designation | | Price | Master Insert* |
|---------------|--------------------------------------|---|-------|----------------|
| | TK45 XNMU 0605.. / 0906.. | | EURO | |
| SM55209 | TK45 XN06 D50 A22 Z05-H | ✓ | 143 € | XNMU 0605.. |
| SM55216 | TK45 XN06 D63 A22 Z06-H | ✓ | 154 € | |
| SM55223 | TK45 XN06 D80 A27 Z08-H | ✓ | 176 € | |
| SM55230 | TK45 XN06 D100 A32 Z09-H | ✓ | 248 € | |
| SM55308 | TK45 XN09 D63 A22 Z05-H | ✓ | 154 € | XNMU 0906.. |
| SM55315 | TK45 XN09 D80 A27 Z06-H | ✓ | 176 € | |
| SM55322 | TK45 XN09 D100 A32 Z08-H | ✓ | 248 € | |
| SM55339 | TK45 XN09 D125 B40 Z10 | - | 358 € | |

Cooling mounting screw is optional / See Page 294 for cooling mounting screws.
İçten su vermeli montaj vidaları opsiyoneldir. / Bkz. Sayfa 294 İçten su vermeli montaj vidaları için.

*Suitable Insert brand is TGTC.

| Size Designation | Master Insert* | Spare Parts | | |
|------------------|----------------|---------------------------|----------------------|------------------------|
| | | Screw | Torx Key | Screw Torque Value |
| D50 - D100 | XNMU 0605.. | SSV M4x12- 9515 | STK-T15- 9910 | 4,3 |
| D63 - D125 | XNMU 0906.. | SSV M5x13- 9519 | STK-T20- 9911 | 8,5 |



| Ordering Code | Item Designation | | Price | Master Insert* |
|---------------|---------------------------|---|-------|----------------|
| | TK45 HNKX 0604.. | | EURO | |
| SM46702 | TK45 HNKX06 D50 A22 Z05-H | ✓ | 134 € | HNKX 0604.. |
| SM46719 | TK45 HNKX06 D63 A22 Z06-H | ✓ | 141 € | |
| SM46726 | TK45 HNKX06 D80 A27 Z08-H | ✓ | 162 € | |

Cooling mounting screw is optional / See Page 294 for cooling mounting screws.
İçten su vermeli montaj vidaları opsiyoneldir. / Bkz. Sayfa 294 İçten su vermeli montaj vidaları için.

*Suitable Insert brand is LMN.

| Size Designation | Master Insert** | Spare Parts | | |
|------------------|-----------------|---------------------------|----------------------|------------------------|
| | | Screw | Torx Key | Screw Torque Value |
| D50 - D80 | HNKX 0604.. | SSV M4x12- 9515 | STK-T15- 9910 | 4,3 |



| Ordering Code | Item Designation | | Price | Master Insert* |
|---------------|-----------------------------|---|-------|----------------|
| | TK45 ON.X 0505.. | | EURO | |
| SM28760 | TK45 ON05 D50 A22 Z05-H | ✓ | 122 € | ON.X 0505.. |
| SM28753 | TK45 ON05 D63 A22 Z06-H | ✓ | 129 € | |
| SM28746 | TK45 ON05 D80 A27 Z07-H | ✓ | 148 € | |
| SM28739 | TK45 ON05 D100 A32 Z08-H | ✓ | 230 € | |

Cooling mounting screw is optional / See Page 294 for cooling mounting screws.
İçten su vermeli montaj vidaları opsiyoneldir. / Bkz. Sayfa 294 İçten su vermeli montaj vidaları için.

*Suitable Insert brand is ISC.

| Size Designation | Master Insert* | Spare Parts | | |
|------------------|----------------|---------------------------|----------------------|------------------------|
| | | Screw | Torx Key | Screw Torque Value |
| D50 - D100 | ON.X 0505.. | SSV M5x13- 9519 | STK-T20- 9911 | 8,5 |



| Ordering Code | Item Designation | | Price | Master Insert* |
|---------------|--------------------------|---|-------|----------------|
| | TK45 ON.X 0606.. | | EURO | |
| SM32453 | TK45 ON06 D63 A22 Z05-H | ✓ | 118 € | ON.X 0606.. |
| SM32477 | TK45 ON06 D80 A27 Z06-H | ✓ | 124 € | |
| SM24588 | TK45 ON06 D100 A32 Z07-H | ✓ | 230 € | |
| SM32507 | TK45 ON06 D125 B40 Z08 | - | 297 € | |

Cooling mounting screw is optional / See Page 294 for cooling mounting screws. *Suitable Insert brand is KRLY.
İçten su vermeli montaj vidaları opsiyoneldir. / Bkz. Sayfa 294 İçten su vermeli montaj vidaları için.

| Size Designation | Master Insert* | Spare Parts | | |
|------------------|----------------|-----------------------|------------------|--------------------|
| | | Screw | Torx Key | Screw Torque Value |
| D63 - D125 | ON.X 0606.. | SSV M5x13-9519 | STK-T20-9911 | N-m 8,5 |



| Ordering Code | Item Designation | | Price | Master Insert* |
|---------------|--------------------------|---|-------|----------------|
| | TK45 PNMU 1205.. | | EURO | |
| SM46894 | TK45 PN12 D63 A22 Z05-H | ✓ | 118 € | PNMU 1205.. |
| SM46900 | TK45 PN12 D80 A27 Z07-H | ✓ | 142 € | |
| SM46917 | TK45 PN12 D100 A32 Z09-H | ✓ | 252 € | |
| SM46924 | TK45 PN12 D125 B40 Z11 | - | 308 € | |

Cooling mounting screw is optional / See Page 294 for cooling mounting screws. *Suitable Insert brand is KYCR.
İçten su vermeli montaj vidaları opsiyoneldir. / Bkz. Sayfa 294 İçten su vermeli montaj vidaları için.

| Size Designation | Master Insert* | Spare Parts | | |
|------------------|----------------|-----------------------|------------------|--------------------|
| | | Screw | Torx Key | Screw Torque Value |
| D63 - D125 | PNMU 1205.. | SSV M5x13-9519 | STK-T20-9911 | N-m 8,5 |



| Ordering Code | Item Designation | | Price | Master Insert* |
|---------------|--------------------------|---|-------|----------------|
| | TK66 PNMU 0905.. | | EURO | |
| SM46931 | TK66 PN09 D50 A22 Z05-H | ✓ | 134 € | PNMU 0905.. |
| SM46948 | TK66 PN09 D63 A22 Z06-H | ✓ | 141 € | |
| SM46955 | TK66 PN09 D80 A27 Z08-H | ✓ | 162 € | |
| SM46962 | TK66 PN09 D100 A32 Z10-H | ✓ | 252 € | |
| SM46979 | TK66 PN09 D125 B40 Z12 | - | 308 € | |

Cooling mounting screw is optional / See Page 294 for cooling mounting screws. *Suitable Insert brand is KYCR.
İçten su vermeli montaj vidaları opsiyoneldir. / Bkz. Sayfa 294 İçten su vermeli montaj vidaları için.

| Size Designation | Master Insert* | Spare Parts | | |
|------------------|----------------|-------------------------|------------------|--------------------|
| | | Screw | Torx Key | Screw Torque Value |
| D50- D125 | PNMU 0905.. | SSV M4x12x5-9529 | STK-T15-9910 | N-m 4,3 |



| Ordering Code | Item Designation | | Price | Master Insert* |
|---------------|--------------------------|---|-------|----------------|
| | TK45 ON.X 0806.. | | EURO | |
| SM28722 | TK45 ON08 D63 A22 Z05-H | ✓ | 118 € | ON.X 0806.. |
| SM28715 | TK45 ON08 D80 A27 Z06-H | ✓ | 124 € | |
| SM28708 | TK45 ON08 D100 A32 Z07-H | ✓ | 142 € | |
| SM14695 | TK45 ON08 D125 B40 Z08 | - | 302 € | |
| SM14718 | TK45 ON08 D160 C40 Z10 | - | 336 € | |
| SM25219 | TK45 ON08 D200 C60 Z12 | - | 493 € | |

Cooling mounting screw is optional / See Page 294 for cooling mounting screws.
İçten su vermeli montaj vidaları opsiyoneldir. / Bkz. Sayfa 294 İçten su vermeli montaj vidaları için.

*Suitable Insert brand is ISO.

| Size Designation | Master Insert* | Spare Parts | | |
|------------------|----------------|-----------------------|------------------|--------------------|
| | | Screw | Torx Key | Screw Torque Value |
| D63 - D200 | ON.X 0606.. | SSV M5x13-9519 | STK-T20-9911 | N·m 8,5 |



| Ordering Code | Item Designation | | Price | Master Insert* |
|---------------|--------------------------------|---|-------|----------------|
| | TK45 ONHU 0604../08T6.. | | EURO | |
| SM42865 | TK45 ONHU06 D63 A22 Z05-H | ✓ | 141 € | ONHU 0604.. |
| SM42872 | TK45 ONHU06 D80 A27 Z06-H | ✓ | 162 € | |
| SM42889 | TK45 ONHU06 D100 A32 Z07-H | ✓ | 241 € | |
| SM44913 | TK45 ONHU08 D63 A22 Z05-H | ✓ | 141 € | ONHU 08T6.. |
| SM44920 | TK45 ONHU08 D80 A27 Z06-H | ✓ | 162 € | |
| SM44937 | TK45 ONHU08 D100 A32 Z07-H | ✓ | 241 € | |

Cooling mounting screw is optional / See Page 294 for cooling mounting screws.
İçten su vermeli montaj vidaları opsiyoneldir. / Bkz. Sayfa 294 İçten su vermeli montaj vidaları için.

*Suitable Insert brand is ZCC-CT.

| Size Designation | Master Insert* | Spare Parts | | |
|------------------|----------------|-----------------------|------------------|--------------------|
| | | Screw | Torx Key | Screw Torque Value |
| D63 - D100 | ONHU 0604.. | SSV M4x12-9515 | STK-T15-9910 | N·m 4,3 |
| D63 - D100 | ONHU 08T6.. | SSV M5x13-9519 | STK-T20-9911 | N·m 8,5 |





| Ordering Code | Item Designation | | Price | Master Insert* |
|---------------|--|---|-------|----------------|
| | TK45 HN.J 0604.. / 0704.. / 0905.. | | EURO | |
| SM40588 | TK45 HN0604 D50 A22 Z05-H | ✓ | 134 € | HN.J 0604..* |
| SM42841 | TK45 HN0604 D63 A22 Z06-H | ✓ | 141 € | |
| SM42858 | TK45 HN0604 D80 A27 Z07-H | ✓ | 162 € | |
| SM44043 | TK45 HN0704 D50 A22 Z05-H | ✓ | 134 € | HN.J 0704..** |
| SM44050 | TK45 HN0704 D63 A22 Z06-H | ✓ | 141 € | |
| SM44067 | TK45 HN0704 D80 A27 Z08-H | ✓ | 179 € | |
| SM42933 | TK45 HN0905 D50 A22 Z04-H | ✓ | 121 € | HN.J 0905..*** |
| SM42940 | TK45 HN0905 D63 A22 Z05-H | ✓ | 134 € | |
| SM42957 | TK45 HN0905 D80 A27 Z06-H | ✓ | 147 € | |
| SM42964 | TK45 HN0905 D100 A32 Z08-H | ✓ | 252 € | |
| SM42971 | TK45 HN0905 D125 B40 Z10 | - | 314 € | |
| SM42988 | TK45 HN0905 D160 C40 Z12 | - | 398 € | |

Cooling mounting screw is optional / See Page 294 for cooling mounting screws.
İçten su vermeli montaj vidaları opsiyoneldir. / Bkz. Sayfa 294 İçten su vermeli montaj vidaları için.

*Suitable Insert brand is KNMTL.

**Suitable Insert brand is WDA.

***Suitable Insert brand is KNMTL/ WDA.

| Size Designation | Master Insert* | Spare Parts | | |
|------------------|----------------|--------------------|--------------|--------------------|
| | | Screw | Torx Key | Screw Torque Value |
| | | | | |
| D50 - D80 | HN.J 0604..* | SSV M4x12-9515 | STK-T15-9910 | 4,3 |
| D50 - D80 | HN.J 0704..** | SSV M4x9x5-9528 | | |
| D50 - D160 | HN.J 0905..*** | SSV M4x12-9515 | | |



| Ordering Code | Item Designation | | Price | Master Insert* |
|---------------|-------------------------------------|---|-------|----------------|
| | TK45 HNGX 0604.. / 0906.. | | EURO | |
| SM42742 | TK45 HN06 D50 A22 Z05-H | ✓ | 134 € | HNGX 0604.. |
| SM40519 | TK45 HN06 D63 A22 Z06-H | ✓ | 141 € | |
| SM40526 | TK45 HN06 D80 A27 Z07-H | ✓ | 162 € | |
| SM40533 | TK45 HN06 D100 A32 Z08-H | ✓ | 230 € | HNGX 0906.. |
| SM42896 | TK45 HN09 D63 A22 Z05-H | ✓ | 121 € | |
| SM40540 | TK45 HN09 D80 A27 Z06-H | ✓ | 142 € | |
| SM40557 | TK45 HN09 D100 A32 Z08-H | ✓ | 252 € | |
| SM40564 | TK45 HN09 D125 B40 Z10 | - | 314 € | |
| SM40571 | TK45 HN09 D160 C40 Z12 | - | 398 € | |

Cooling mounting screw is optional / See Page 294 for cooling mounting screws.
İçten su vermeli montaj vidaları opsiyoneldir. / Bkz. Sayfa 294 İçten su vermeli montaj vidaları için.

*Suitable Insert brand is PRMT.

| Size Designation | Master Insert* | Spare Parts | | |
|------------------|----------------|-------------------|--------------|--------------------|
| | | Screw | Torx Key | Screw Torque Value |
| | | | | |
| D50 - D100 | HNGX 0604.. | SSV M3x8-9508 | STK-T08-9908 | 1,9 |
| D63 - D160 | HNGX 0906.. | SSV M4x12-9515 | STK-T15-9910 | 4,3 |



| Ordering Code | Item Designation | | Price | Master Insert* |
|---------------|----------------------------|---|-------|----------------|
| | TK45 ONMU 0504.. | | EURO | |
| SM53502 | TK45 ON0504 D50 A22 Z05-H | ✓ | 162 € | ONMU 0504.. |
| SM53519 | TK45 ON0504 D63 A27 Z05-H | ✓ | 218 € | |
| SM53526 | TK45 ON0504 D80 A27 Z08-H | ✓ | 274 € | |
| SM54707 | TK45 ON0504 D100 A32 Z09-H | ✓ | 370 € | |

Cooling mounting screw is optional / See Page 294 for cooling mounting screws.
İçten su vermeli montaj vidaları opsiyoneldir. / Bkz. Sayfa 294 İçten su vermeli montaj vidaları için.

*Suitable Insert brand is SCO.

| Size Designation | Master Insert* | Spare Parts | | |
|------------------|----------------|-----------------------|------------------|--------------------|
| | | Screw | Torx Key | Screw Torque Value |
| D50 - D100 | ONMU 0504.. | SSV M4x10-9514 | STK-T15-9910 | N-m 4,3 |



| Ordering Code | Item Designation | | Price | Master Insert* |
|---------------|--------------------------|---|-------|----------------|
| | TK45 OD.. 0504.. | | EURO | |
| SM28814 | TK45 OD05 D40 A16 Z04-H | ✓ | 82 € | OD.. 0504.. |
| SM28807 | TK45 OD05 D50 A22 Z05-H | ✓ | 100 € | |
| SM28791 | TK45 OD05 D63 A22 Z06-H | ✓ | 119 € | |
| SM28784 | TK45 OD05 D80 A27 Z07-H | ✓ | 133 € | |
| SM28777 | TK45 OD05 D100 A32 Z08-H | ✓ | 195 € | |

Cooling mounting screw is optional / See Page 294 for cooling mounting screws.
İçten su vermeli montaj vidaları opsiyoneldir. / Bkz. Sayfa 294 İçten su vermeli montaj vidaları için.

*Suitable Insert brand is PRMT.

| Size Designation | Master Insert* | Spare Parts | | |
|------------------|----------------|-------------------------|------------------|--------------------|
| | | Screw | Torx Key | Screw Torque Value |
| D40 - D100 | OD.. 0504.. | SSV M3.5x10-9511 | STK-T15-9910 | N-m 2,9 |



| Ordering Code | Item Designation | | Price | Master Insert* |
|---------------|--------------------------|---|-------|----------------|
| | TK43 OF.. 07T3.. | | EURO | |
| SM25172 | TK43 OF07T3 D63 A22 Z05 | - | 142 € | OF.. 07T3.. |
| SM25189 | TK43 OF07T3 D80 A27 Z06 | - | 156 € | |
| SM25196 | TK43 OF07T3 D100 A32 Z07 | - | 213 € | |
| SM25202 | TK43 OF07T3 D125 B40 Z09 | - | 284 € | |

*Suitable Insert brand is ISO.

| Size Designation | Master Insert* | Spare Parts | | |
|------------------|----------------|------------------|--------------------------|------------------|
| | | Clamp Part | Screw | Allen Key |
| D63 - D125 | OF.. 07T3.. | TKBP 9116 | TKSV M8x1x18 9227 | SAK-AA5-9904 |





| Ordering Code | Item Designation | | Price | Master Insert* |
|---------------|------------------------------------|---|-------------|----------------|
| | ST RNMU 1004.. / 1205.. | | <i>EURO</i> | |
| SM45446 | ST RN10 D25 W25 L150 Z02-H | ✓ | 131 € | RNMU 1004.. |
| SM45453 | ST RN10 D32 W32 L150 Z03-H | ✓ | 139 € | |
| SM47624 | ST RN12 D32 W32 L150 Z02-H | ✓ | 139 € | RNMU 1205.. |
| SM47631 | ST RN12 D40 W32 L150 Z03-H | ✓ | 151 € | |



| Ordering Code | Item Designation | | Price | Master Insert* |
|---------------|------------------------------------|---|-------------|----------------|
| | MT RNMU 1004.. / 1205.. | | <i>EURO</i> | |
| SM48959 | MT RN10 D25 M12 L35 Z02-H | ✓ | 104 € | RNMU 1004.. |
| SM48966 | MT RN10 D32 M16 L43 Z03-H | ✓ | 118 € | |
| SM48973 | MT RN12 D32 M16 L43 Z02-H | ✓ | 118 € | RNMU 1205.. |
| SM40151 | MT RN12 D40 M16 L43 Z03-H | ✓ | 122 € | |



| Ordering Code | Item Designation | | Price | Master Insert* |
|---------------|---|---|-------------|----------------|
| | TK RNMU 1004.. / 1205.. / 1606.. | | <i>EURO</i> | |
| SM43060 | TK RN10 D40 A16 Z04-H | ✓ | 127 € | RNMU 1004.. |
| SM43077 | TK RN10 D50 A22 Z05-H | ✓ | 151 € | |
| SM43084 | TK RN12 D40 A16 Z04-H | ✓ | 127 € | RNMU 1205.. |
| SM40168 | TK RN12 D50 A22 Z05-H | ✓ | 151 € | |
| SM43091 | TK RN12 D63 A22 Z06-H | ✓ | 185 € | RNMU 1606.. |
| SM43107 | TK RN16 D50 A22 Z04-H | ✓ | 151 € | |
| SM43114 | TK RN16 D63 A22 Z05-H | ✓ | 185 € | |
| SM43121 | TK RN16 D80 A27 Z06-H | ✓ | 192 € | |















Cooling mounting screw is optional / See Page 294 for cooling mounting screws.
İçten su vermeli montaj vidaları opsiyoneldir. / Bkz. Sayfa 294 İçten su vermeli montaj vidaları için.

*Suitable Insert brand is TGTC.

Copy Milling Tools

| Size Designation | Master Insert* | Spare Parts | | |
|------------------|----------------|---------------------|--------------|---------------------------|
| | | Screw | Torx Key | Screw Torque Value N·m |
| D25 - D50 | RNMU 1004.. | SSV M3.5x10-9511 | STK-T15-9910 | 2,9 |
| D32 - D63 | RNMU 1205.. | SSV M4x9x5-9528 | | 4,3 |
| D50 - D80 | RNMU 1606.. | SSV M5x13-9519 | STK-T20-9911 | 8,5 |



| Ordering Code | Item Designation | | Price | Master Insert* |
|---|--|---|-------------|---|
| ST RD.. 0501.. / 0702.. / 0803.. / 1003.. 10T3.. / 12T3.. / 1204.. | |  | <i>EURO</i> |  |
| SM58972 | ST RD05 D08 W10 L100 Z01-H  | ✓ | 78 € | RDMX 0501..* |
| SM58989 | ST RD05 D10 W12 L100 Z02-H  | ✓ | 78 € | |
| SM58996 | ST RD05 D12 W12 L100 Z02-H  | ✓ | 86 € | |
| SM59009 | ST RD05 D14 W12 L100 Z03-H  | ✓ | 90 € | |
| SM45415 | ST RD07 D16 W16 L120 Z02 | | - | RDKW 0702..** |
| SM45422 | ST RD07 D20 W20 L120 Z02 | | - | |
| SM54400 | ST RD07 D20 W20 L120 Z03  | | - | |
| SM45439 | ST RD07 D25 W25 L120 Z03 | | - | |
| SM54417 | ST RD07 D25 W25 L120 Z04 | | - | |
| SM13124 | ST RD08 D16 W16 L120 Z02 | | - | RD.. 0803..** |
| SM13162 | ST RD08 D16 W16 L150 Z02 | | - | |
| SM13131 | ST RD08 D20 W20 L120 Z02 | | - | |
| SM13179 | ST RD08 D20 W20 L150 Z02 | | - | |
| SM13209 | ST RD08 D20 C20 L200 Z02 | | - | |
| SM13148 | ST RD08 D25 W25 L120 Z03 | | - | |
| SM13186 | ST RD08 D25 W25 L150 Z03 | | - | |
| SM13216 | ST RD08 D25 C25 L200 Z03 | | - | |
| SM13155 | ST RD08 D32 W32 L120 Z04 | | - | |
| SM13193 | ST RD08 D32 W32 L150 Z04 | | - | |
| SM13223 | ST RD08 D32 C32 L200 Z04 | | - | RD.. 1003..** |
| SM13230 | ST RD1003 D20 W20 L120 Z02 | | - | |
| SM13261 | ST RD1003 D20 W20 L150 Z02 | | - | |
| SM13292 | ST RD1003 D20 C20 L200 Z02 | | - | |
| SM13247 | ST RD1003 D25 W25 L120 Z03 | | - | |
| SM13278 | ST RD1003 D25 W25 L150 Z03 | | - | |
| SM13308 | ST RD1003 D25 C25 L200 Z03 | | - | |
| SM37113 | ST RD1003 D32 W25 L120 Z03 | | - | |
| SM13254 | ST RD1003 D32 W32 L120 Z03 | | - | |
| SM13285 | ST RD1003 D32 W32 L150 Z03 | | - | |
| SM37120 | ST RD1003 D32 W25 L150 Z03 | | - | RD.. 10T3..** |
| SM13315 | ST RD1003 D32 C32 L200 Z03 | | - | |
| SM37137 | ST RD1003 D32 C25 L200 Z03 | | - | |
| SM13322 | ST RD1003 D40 W32 L120 Z04 | | - | |
| SM13339 | ST RD1003 D40 W32 L150 Z04 | | - | RD.. 12T3..** |
| SM13346 | ST RD1003 D40 C32 L200 Z04 | | - | |
| SM54424 | ST RD10T3 D20 W20 L150 Z02  | | - | |
| SM54431 | ST RD10T3 D25 W25 L150 Z02  | | - | |
| SM54448 | ST RD10T3 D32 W32 L150 Z03  | | - | |
| SM13353 | ST RD12T3 D25 W25 L120 Z02 | | - | |
| SM13360 | ST RD12T3 D25 W25 L150 Z02 | | - | |
| SM13377 | ST RD12T3 D25 C25 L200 Z02 | | - | |
| SM37168 | ST RD12T3 D32 W25 L120 Z03 | | - | |
| SM13384 | ST RD12T3 D32 W32 L120 Z03 | | - | |
| SM13391 | ST RD12T3 D32 W32 L150 Z03 | | - | RD.. 1204..** |
| SM37182 | ST RD12T3 D32 W25 L150 Z03 | | - | |
| SM13407 | ST RD12T3 D32 C32 L200 Z03 | | - | |
| SM39087 | ST RD12T3 D32 C25 L200 Z03 | | - | |
| SM13414 | ST RD12T3 D40 W32 L120 Z04 | | - | |
| SM13421 | ST RD12T3 D40 W32 L150 Z04 | | - | |
| SM13438 | ST RD12T3 D40 C32 L200 Z04 | | - | |
| SM52802 | ST RD1204 D25 W25 L150 Z02  | | - | |
| SM54455 | ST RD1204 D26 W25 L150 Z02  | | - | |
| SM54462 | ST RD1204 D32 W32 L150 Z03  | | - | |
| SM54479 | ST RD1204 D33 W32 L150 Z03  | | - | |

*Suitable Insert brand is TGTC.

**Suitable Insert brand is ISO.



Copy Milling Tools





| Ordering Code | Item Designation | | Price | Master Insert* |
|---------------|--|--|-------|----------------|
| | MT RD.. 0702.. / 0803.. / 1003.. / 10T3.. / 12T3.. / 1204.. | | EURO | |
| SM56602 | MT RD07 D16 M08 L25 Z02-H | | 88 € | RDKW 0702.. |
| SM56619 | MT RD07 D20 M10 L30 Z03-H | | 73 € | |
| SM56626 | MT RD07 D25 M12 L35 Z04-H | | 88 € | |
| SM25783 | MT RD08 D16 M08 L25 Z02-H | | 101 € | RD.. 0803.. |
| SM39544 | MT RD08 D20 M10 L30 Z02-H | | 73 € | |
| SM23970 | MT RD08 D20 M10 L30 Z03-H | | 78 € | |
| SM39551 | MT RD08 D25 M12 L35 Z03-H | | 88 € | |
| SM23987 | MT RD08 D25 M12 L35 Z04-H | | 92 € | |
| SM39537 | MT RD08 D35 M16 L43 Z04-H | | 103 € | RD.. 1003.. |
| SM15654 | MT RD1003 D20 M10 L30 Z02-H | | 83 € | |
| SM15661 | MT RD1003 D25 M12 L35 Z03-H | | 88 € | |
| SM15678 | MT RD1003 D30 M16 L43 Z03-H | | 95 € | |
| SM15685 | MT RD1003 D32 M16 L43 Z04-H | | 100 € | |
| SM15692 | MT RD1003 D35 M16 L43 Z04-H | | 100 € | |
| SM15647 | MT RD1003 D40 M16 L43 Z04-H | | 103 € | |
| SM15708 | MT RD1003 D42 M16 L43 Z05-H | | 108 € | RD.. 10T3.. |
| SM54486 | MT RD10T3 D20 M10 L30 Z02-H | | 73 € | |
| SM54493 | MT RD10T3 D25 M12 L35 Z02-H | | 88 € | |
| SM54509 | MT RD10T3 D32 M16 L43 Z03-H | | 95 € | RD.. 12T3.. |
| SM15715 | MT RD12T3 D24 M12 L35 Z02-H | | 92 € | |
| SM15722 | MT RD12T3 D25 M12 L35 Z02-H | | 92 € | |
| SM15739 | MT RD12T3 D32 M16 L43 Z03-H | | 100 € | |
| SM15746 | MT RD12T3 D35 M16 L43 Z03-H | | 100 € | |
| SM15753 | MT RD12T3 D40 M16 L43 Z04-H | | 103 € | |
| SM15760 | MT RD12T3 D42 M16 L43 Z04-H | | 108 € | |
| SM52819 | MT RD1204 D32 M16 L43 Z03-H | | 100 € | RD.. 1204.. |
| SM54516 | MT RD1204 D35 M16 L43 Z03-H | | 100 € | |
| SM54523 | MT RD1204 D40 M16 L43 Z04-H | | 103 € | |
| SM52826 | MT RD1204 D42 M16 L43 Z04-H | | 108 € | |

*Suitable Insert brand is ISO.

| Size Designation | Master Insert* | Spare Parts | | | | |
|------------------|--------------------------|---------------------------|------------------|--------------|------------------------|--------------------|
| | | Screw | Torx Key | Wedge Clamp | Clamp Screw | Screw Torque Value |
| D10 - D14 | RDMX 0501.. | SSV M2x4-9521 | STK-T06-9906 | | | 0,6 |
| D16 - D25 | RDKW 0702.. | SSV M2.5x5-9505 | STK-T08-9908 | - | - | 1,2 |
| D16 - D32 | RD.. 0803.. | SSV M3x6-9507 | | | | 1,9 |
| D20 | RD.. 1003.. | SSV M3.5x8-9513 | STK-T10-9909 | | | 2,9 |
| | RD.. 10T3.. | SSV M3.5x8-9510 | | | | |
| D25 - D40 | RD.. 1003.. | SSV M3.5x8-SC-9513 | STK-T15-9910 | RDTP 9124 | SSV M3.5x11 9532 | |
| | RD.. 10T3.. | SSV M3.5x8-9510 | | | | |
| D25 - D40 | RD.. 12T3 RD.. 1204.. | SSV M3.5x10-9511 | | | | |



| Ordering Code | Item Designation | | Price | Master Insert* |
|------------------------------------|--------------------------|---|-------------|---|
| TK RD.. | | | | |
| 1003../10T3../12T3../1204.. | |  | EURO |  |
| SM28180 | TK RD1003 D40 A16 Z04-H | ✓ | 73 € | RD.. 1003.. |
| SM21075 | TK RD1003 D40 A16 Z04 | - | 68 € | |
| SM28173 | TK RD1003 D50 A22 Z05-H | ✓ | 88 € | |
| SM21082 | TK RD1003 D50 A22 Z05 | - | 83 € | |
| SM50242 | TK RD1003 D52 A22 Z05-H | ✓ | 96 € | |
| SM28166 | TK RD1003 D63 A22 Z06-H | ✓ | 112 € | |
| SM21099 | TK RD1003 D63 A22 Z06 | - | 106 € | |
| SM50259 | TK RD1003 D66 A27 Z06-H | ✓ | 121 € | |
| SM28159 | TK RD1003 D80 A27 Z07-H | ✓ | 131 € | |
| SM21105 | TK RD1003 D80 A27 Z07 | - | 125 € | |
| SM28142 | TK RD1003 D100 A32 Z08-H | ✓ | 146 € | |
| SM21112 | TK RD1003 D100 A32 Z08 | - | 140 € | |
| SM26032 | TK RD1003 D125 B40 Z09 | - | 203 € | RD.. 10T3.. |
| SM32958 | TK RD10T3 D40 A16 Z04-H | ✓ | 73 € | |
| SM32903 | TK RD10T3 D40 A16 Z04 | - | 68 € | |
| SM32934 | TK RD10T3 D50 A22 Z05-H | ✓ | 88 € | |
| SM32910 | TK RD10T3 D50 A22 Z05 | - | 83 € | |
| SM32941 | TK RD10T3 D63 A22 Z06-H | ✓ | 112 € | |
| SM32927 | TK RD10T3 D63 A22 Z06 | - | 106 € | RD.. 12T3.. |
| SM28135 | TK RD12T3 D40 A16 Z04-H | ✓ | 73 € | |
| SM21006 | TK RD12T3 D40 A16 Z04 | - | 68 € | |
| SM28128 | TK RD12T3 D50 A22 Z05-H | ✓ | 88 € | |
| SM21013 | TK RD12T3 D50 A22 Z05 | - | 83 € | |
| SM50266 | TK RD12T3 D52 A22 Z05-H | ✓ | 93 € | |
| SM28111 | TK RD12T3 D63 A22 Z06-H | ✓ | 112 € | |
| SM21020 | TK RD12T3 D63 A22 Z06 | - | 106 € | |
| SM50273 | TK RD12T3 D66 A27 Z06-H | ✓ | 121 € | |
| SM28104 | TK RD12T3 D80 A27 Z07-H | ✓ | 131 € | |
| SM21037 | TK RD12T3 D80 A27 Z07 | - | 125 € | |
| SM28098 | TK RD12T3 D100 A32 Z08-H | ✓ | 146 € | |
| SM21044 | TK RD12T3 D100 A32 Z08 | - | 140 € | RD.. 1204.. |
| SM21051 | TK RD12T3 D125 B40 Z09 | - | 203 € | |
| SM32972 | TK RD1204 D40 A16 Z04-H | ✓ | 73 € | |
| SM32897 | TK RD1204 D40 A16 Z04 | - | 68 € | |
| SM32989 | TK RD1204 D50 A22 Z05-H | ✓ | 88 € | |
| SM32965 | TK RD1204 D50 A22 Z05 | - | 83 € | |
| SM33252 | TK RD1204 D63 A22 Z06-H | ✓ | 112 € | |
| SM33245 | TK RD1204 D63 A22 Z06 | - | 106 € | |
| SM33276 | TK RD1204 D80 A27 Z07-H | ✓ | 131 € | |
| SM33269 | TK RD1204 D80 A27 Z07 | - | 125 € | |
| SM33290 | TK RD1204 D100 A32 Z08-H | ✓ | 146 € | |
| SM33283 | TK RD1204 D100 A32 Z08 | - | 140 € | |
| SM60814 | TK RD1604 D63 A22 Z04-H | ✓ | 106 € | |
| SM33320 | TK RD1604 D63 A22 Z05-H | ✓ | 114 € | |
| SM33306 | TK RD1604 D63 A22 Z05 | - | 108 € | |
| SM33368 | TK RD1604 D80 A27 Z06-H | ✓ | 131 € | |
| SM33351 | TK RD1604 D80 A27 Z06 | - | 125 € | |
| SM33382 | TK RD1604 D100 A32 Z07-H | ✓ | 146 € | |
| SM33375 | TK RD1604 D100 A32 Z07 | - | 140 € | |
| SM54394 | TK RD1604 D125 B40 Z08 | - | 246 € | |

Copy Milling Tools

| Size Designation | Master Insert* | Spare Parts | | | | | |
|------------------|----------------|-----------------------|--------------|--------------|------------------------|--------------------|--|
| | | Screw | Torx Key | Wedge Clamp | Clamp Screw | Screw Torque Value | |
| D40 - D125 | RD.. 1003.. | SSV M3.5x8-SC-9513 | STK-T10-9909 | RDTP 9124 | SSV M3.5x11 9532 | 2,9 | |
| | RD.. 10T3.. | SSV M3.5x8-9510 | STK-T15-9910 | | | | |
| D40 - D125 | RD.. 12T3.. | SSV M3.5x10-9511 | | | | | |
| D63 - D125 | RD.. 1604.. | SSV M4.5x11-9518 | STK-T20-9911 | | | | |



| Ordering Code | Item Designation | | Price | Master Insert* |
|--|------------------------------|---|-------------|----------------|
| ST RPMT 10T3.. / 1204.. | | | <i>EURO</i> | |
| SM51577 | ST RP10T3 D25 W25 L150 Z03-H | ✓ | 87 € | RPMT 10T3.. |
| SM51584 | ST RP10T3 D32 W32 L150 Z04-H | ✓ | 93 € | |
| SM51591 | ST RP1204 D25 W25 L150 Z02-H | ✓ | 87 € | RPMT 1204.. |



| Ordering Code | Item Designation | | Price | Master Insert* |
|--|-----------------------------|---|-------------|----------------|
| MT RPMT 10T3.. / 1204.. | | | <i>EURO</i> | |
| SM49888 | MT RP10T3 D25 M12 L35 Z03-H | ✓ | 95 € | RPMT 10T3.. |
| SM49895 | MT RP10T3 D32 M16 L43 Z04-H | ✓ | 108 € | |
| SM49901 | MT RP10T3 D35 M16 L43 Z04-H | ✓ | 108 € | |
| SM49918 | MT RP10T3 D40 M16 L43 Z04-H | ✓ | 111 € | |
| SM49925 | MT RP10T3 D42 M16 L43 Z05-H | ✓ | 115 € | RPMT 1204.. |
| SM49932 | MT RP1204 D25 M12 L35 Z02-H | ✓ | 95 € | |
| SM49949 | MT RP1204 D32 M16 L43 Z03-H | ✓ | 108 € | |
| SM49956 | MT RP1204 D35 M16 L43 Z03-H | ✓ | 108 € | |
| SM49963 | MT RP1204 D40 M16 L43 Z04-H | ✓ | 111 € | |
| SM49970 | MT RP1204 D42 M16 L43 Z04-H | ✓ | 115 € | |



| Ordering Code | Item Designation | | Price | Master Insert* |
|--|--------------------------|---|-------------|----------------|
| TK RPMT 10T3.. / 1204.. | | | <i>EURO</i> | |
| SM50372 | TK RP10T3 D40 A16 Z04-H | ✓ | 77 € | RPMT 10T3.. |
| SM50389 | TK RP10T3 D50 A22 Z05-H | ✓ | 93 € | |
| SM50396 | TK RP10T3 D52 A22 Z05-H | ✓ | 93 € | |
| SM50402 | TK RP10T3 D63 A22 Z06-H | ✓ | 121 € | |
| SM50419 | TK RP10T3 D66 A27 Z06-H | ✓ | 131 € | |
| SM50426 | TK RP10T3 D80 A27 Z07-H | ✓ | 140 € | |
| SM50433 | TK RP10T3 D100 A32 Z08-H | ✓ | 156 € | RPMT 1204.. |
| SM33764 | TK RP1204 D40 A16 Z04-H | ✓ | 77 € | |
| SM33788 | TK RP1204 D50 A22 Z05-H | ✓ | 93 € | |
| SM50334 | TK RP1204 D52 A22 Z05-H | ✓ | 93 € | |
| SM33801 | TK RP1204 D63 A22 Z06-H | ✓ | 110 € | |
| SM50341 | TK RP1204 D66 A27 Z06-H | ✓ | 131 € | |
| SM33825 | TK RP1204 D80 A27 Z07-H | ✓ | 128 € | |
| SM50365 | TK RP1204 D100 A32 Z08-H | ✓ | 156 € | |
| SM00678 | TK RP1204 D125 B40 Z09 | - | 232 € | |

Cooling mounting screw is optional / See Page 294 for cooling mounting screws.
İçten su vermeli montaj vidaları opsiyoneldir. / Bkz. Sayfa 294 İçten su vermeli montaj vidaları için.

*Suitable Insert brand is MTSBH.

Copy Milling Tools

| Size Designation | Master Insert* | Spare Parts | | |
|------------------|----------------|-----------------------------|----------------------|---------------------------|
| | | Screw | Torx Key | Screw Torque Value N-m |
| D25 - D100 | RPMT 10T3.. | SSV M3.5x10- 9511 | STK-T15- 9910 | 2,9 |
| D25 - D125 | RPMT 1204.. | SSV M4x9x5- 9528 | | 4,3 |



| Ordering Code | Item Designation | | Price | Master Insert* |
|---------------|---|---|-------------|----------------|
| | ST R.P.T 10T3.. / 1204.. | | EURO | |
| SM47105 | ST RPMT10 D25 W25 L150 Z02-H | ✓ | 87 € | RPMT 10T3.. |
| SM47112 | ST RPMT10 D32 W32 L150 Z03-H | ✓ | 93 € | |
| SM47129 | ST RPMT10 D35 W32 L150 Z03-H | ✓ | 101 € | |
| SM47136 | ST RPMT12 D32 W32 L150 Z03-H | ✓ | 93 € | R.P.T 1204.. |
| SM47143 | ST RPMT12 D40 W32 L150 Z04-H | ✓ | 116 € | |



| Ordering Code | Item Designation | | Price | Master Insert* |
|---------------|---|---|-------------|----------------|
| | MT R.P.T 10T3.. / 1204.. | | EURO | |
| SM47068 | MT RPMT10 D25 M12 L35 Z02-H | ✓ | 100 € | RPMT 10T3.. |
| SM47075 | MT RPMT10 D32 M16 L43 Z03-H | ✓ | 113 € | |
| SM47082 | MT RPMT12 D32 M16 L43 Z03-H | ✓ | 113 € | RPMT 1204.. |
| SM47099 | MT RPMT12 D40 M16 L43 Z04-H | ✓ | 118 € | |



| Ordering Code | Item Designation | | Price | Master Insert* |
|---------------|---|---|-------------|----------------|
| | TK RPMT 10T3.. / 1204.. / 1605.. | | EURO | |
| SM46603 | TK RPMT10 D40 A16 Z04-H | ✓ | 77 € | RPMT 10T3.. |
| SM46610 | TK RPMT10 D50 A22 Z05-H | ✓ | 93 € | |
| SM46627 | TK RPMT10 D63 A22 Z06-H | ✓ | 121 € | |
| SM46559 | TK RPMT12 D40 A16 Z04-H | ✓ | 77 € | RPMT 1204.. |
| SM46566 | TK RPMT12 D50 A22 Z05-H | ✓ | 93 € | |
| SM46573 | TK RPMT12 D52 A22 Z05-H | ✓ | 101 € | |
| SM46580 | TK RPMT12 D63 A22 Z06-H | ✓ | 121 € | |
| SM46597 | TK RPMT12 D80 A27 Z07-H | ✓ | 140 € | |
| SM54110 | TK RPMT16 D63 A22 Z04-H | ✓ | 118 € | RPMT 1605.. |
| SM54127 | TK RPMT16 D80 A27 Z05-H | ✓ | 131 € | |
| SM54134 | TK RPMT16 D100 A32 Z06-H | ✓ | 174 € | |
| SM54141 | TK RPMT16 D125 B40 Z07 | - | 263 € | |

Cooling mounting screw is optional / See Page 294 for cooling mounting screws.
İçten su vermeli montaj vidaları opsiyoneldir. / Bkz. Sayfa 294 İçten su vermeli montaj vidaları için.

*Suitable Insert brand is KYCR.

Copy Milling Tools

| Size Designation | Master Insert* | Spare Parts | | |
|------------------|----------------|-------------------|--------------|---------------------------|
| | | Screw | Torx Key | Screw Torque Value N-m |
| D25 - D63 | RPMT 10T3.. | SSV M3x8-9508 | STK-T08-9908 | 1,9 |
| D32 - D80 | RPMT 1204.. | SSV M4x10-9514 | STK-T15-9910 | 4,3 |
| D63 - D125 | RPMT 1605.. | SSV M5x13-9519 | STK-T20-9911 | 8,5 |



| Ordering Code | Item Designation | | Price | Master Insert* |
|---------------|------------------------------------|---|-------|----------------|
| | ST QPMT 10T3.. / 1204.. | | EURO | |
| SM22935 | ST QP10 D25 W25 L150 Z02 | - | 80 € | QPMT 10T3.. |
| SM22959 | ST QP10 D32 W32 L150 Z03 | - | 85 € | |
| SM22942 | ST QP10 D25 C25 L200 Z02 | - | 94 € | |
| SM22966 | ST QP10 D32 C32 L200 Z03 | - | 99 € | |
| SM22973 | ST QP12 D25 W25 L150 Z02 | - | 80 € | QPMT 1204.. |



| Ordering Code | Item Designation | | Price | Master Insert* |
|---------------|--------------------------------|---|-------|----------------|
| | MT QPMT 10T3.. SMTM | | EURO | |
| SM23932 | MT QP10T3 D25 M12 L35 Z03-H | ✓ | 94 € | QPMT 10T3.. |
| SM23949 | MT QP10T3 D32 M16 L43 Z03-H | ✓ | 103 € | |
| SM23956 | MT QP10T3 D40 M16 L43 Z04-H | ✓ | 106 € | |



| Ordering Code | Item Designation | | Price | Master Insert* |
|---------------|------------------------------------|---|-------|----------------|
| | TK QPMT 10T3.. / 1204.. | | EURO | |
| SM28326 | TK QP10T3 D40 A16 Z04-H | ✓ | 76 € | QPMT 10T3.. |
| SM28319 | TK QP10T3 D50 A22 Z05-H | ✓ | 88 € | |
| SM28302 | TK QP10T3 D63 A22 Z06-H | ✓ | 106 € | |
| SM22652 | TK QP10T3 D80 A27 Z07-H | ✓ | 124 € | |
| SM22669 | TK QP1204 D63 A22 Z06-H | ✓ | 106 € | QPMT 1204.. |
| SM22676 | TK QP1204 D80 A27 Z07-H | ✓ | 124 € | |
| SM22683 | TK QP1204 D100 A32 Z09-H | ✓ | 142 € | |

Cooling mounting screw is optional / See Page 294 for cooling mounting screws.
İçten su vermeli montaj vidaları opsiyoneldir. / Bkz. Sayfa 294 İçten su vermeli montaj vidaları için.

*Suitable Insert brand is SMTM.

| Size Designation | Master Insert* | Spare Parts | | |
|------------------|----------------|----------------|--------------|--------------------|
| | | Screw | Torx Key | Screw Torque Value |
| D25 - D80 | | | | |
| D25 - D100 | QPMT 1204.. | SSV M4x10-9514 | STK-T15-9910 | 4,3 |





| Ordering Code | Item Designation | | Price | Master Insert* |
|---------------|---------------------------------------|---|-------|----------------|
| | TK RCKT 10T3.. / 1204..ZCC | | EURO | |
| SM33429 | TK RC10 D40 A16 Z04-H | ✓ | 71 € | RCKT 10T3.. |
| SM34747 | TK RC10 D50 A22 Z05-H | ✓ | 85 € | |
| SM33450 | TK RC10 D63 A22 Z06-H | ✓ | 110 € | |
| SM33474 | TK RC12 D50 A22 Z05-H | ✓ | 85 € | RCKT 1204.. |
| SM33498 | TK RC12 D63 A22 Z06-H | ✓ | 110 € | |
| SM33511 | TK RC12 D80 A27 Z07-H | ✓ | 128 € | |

Cooling mounting screw is optional / See Page 294 for cooling mounting screws.
İçten su vermeli montaj vidaları opsiyoneldir. / Bkz. Sayfa 294 İçten su vermeli montaj vidaları için.



*Suitable Insert brand is ZCC-CT.

| Size Designation | Master Insert** | Spare Parts | | | | |
|------------------|-----------------|------------------|--------------|-------------|------------------|--------------------|
| | | Screw | Torx Key | Wedge Clamp | Clamp Screw | Screw Torque Value |
| D40 - D63 | | | | | | |
| D50 - D80 | RCKT 1204 | SSV M3.5x10-9511 | STK-T15-9910 | RDTP 9124 | SSV M3.5x11-9532 | 2,9 |



| Ordering Code | Item Designation | | Price | Master Insert* |
|---------------|-------------------------------|---|-------|---|
| | ST RCKT 1204.. |  | EURO |  |
| SM51539 | ST RC1204S D28 W25 L150 Z02-H | ✓ | 92 € | RCKT 1204.. |
| SM51546 | ST RC1204S D32 W32 L150 Z03-H | ✓ | 93 € | |
| SM39940 | ST RC1204S D33 W32 L150 Z03 | - | 90 € | |
| SM51553 | ST RC1204S D35 W32 L150 Z03-H | ✓ | 97 € | |





| Ordering Code | Item Designation | | Price | Master Insert* |
|---------------|--------------------------|---|-------|---|
| | TK RCKT 1204.. |  | EURO |  |
| SM33696 | TK RC1204S D50 A22 Z05-H | ✓ | 85 € | RCKT 1204.. |
| SM33719 | TK RC1204S D63 A22 Z06-H | ✓ | 110 € | |
| SM33733 | TK RC1204S D80 A27 Z07-H | ✓ | 128 € | |

Cooling mounting screw is optional / See Page 294 for cooling mounting screws.
İçten su vermeli montaj vidaları opsiyoneldir. / Bkz. Sayfa 294 İçten su vermeli montaj vidaları için.



*Suitable Insert brand is SNDV.

| Size Designation | Master Insert* | Spare Parts | | | | |
|------------------|--|--|---|---|---|---|
| | | Screw | Torx Key | Wedge Clamp | Clamp Screw | Screw Torque Value |
| D28 - D80 |  RCKT 1204.. |  SSV M3.5x10-9511 |  STK-T15-9910 |  RDTP 9124 |  SSV M3.5x11 9532 |  N-m 2,9 |







| Ordering Code | Item Designation | | Price | Master Insert* |
|---------------|------------------------------|---|-------|---|
| | MT RPNX 10T3.. / 1204 |  | EURO |  |
| SM38936 | MT RP10 D25 M12 L35 Z02-H | ✓ | 87 € | RPNX 10T3.. |
| SM38943 | MT RP10 D30 M16 L43 Z03-H | ✓ | 94 € | |
| SM38981 | MT RP10 D32 M16 L43 Z03-H | ✓ | 96 € | |
| SM38998 | MT RP10 D35 M16 L43 Z04-H | ✓ | 96 € | |
| SM39001 | MT RP10 D40 M16 L43 Z04-H | ✓ | 102 € | |
| SM39018 | MT RP10 D42 M16 L43 Z04-H | ✓ | 102 € | |
| SM39032 | MT RP12 D32 M16 L43 Z03-H | ✓ | 96 € | RPNX 1204.. |
| SM39049 | MT RP12 D35 M16 L43 Z03-H | ✓ | 96 € | |
| SM39056 | MT RP12 D40 M16 L43 Z04-H | ✓ | 102 € | |
| SM39063 | MT RP12 D42 M16 L43 Z04-H | ✓ | 106 € | |



| Ordering Code | Item Designation | | Price | Master Insert* |
|---------------|------------------------------------|---|-------|---|
| | TK RPNX 10T3.. / 1204..CRTZ |  | EURO |  |
| SM33535 | TK RP10 D40 A16 Z04-H | ✓ | 71 € | RPNX 10T3.. |
| SM33559 | TK RP10 D50 A22 Z05-H | ✓ | 85 € | |
| SM33573 | TK RP10 D63 A22 Z06-H | ✓ | 110 € | |
| SM33597 | TK RP10 D80 A27 Z07-H | ✓ | 128 € | RPNX 1204.. |
| SM33610 | TK RP12 D50 A22 Z05-H | ✓ | 85 € | |
| SM33634 | TK RP12 D63 A22 Z06-H | ✓ | 110 € | |
| SM33658 | TK RP12 D80 A27 Z07-H | ✓ | 128 € | |
| SM33672 | TK RP12 D100 A32 Z08-H | ✓ | 174 € | |

*Suitable Insert brand is CRTZ.

| Size Designation | Master Insert* | Spare Parts | | |
|------------------|--|---|---|--------------------|
| | | Screw | Torx Key | Screw Torque Value |
| D25 - D80 |  RPNX 10T3.. |  SSV M3x8-9508 |  STK-T08-9908 | 1,9 |
| D32 - D100 | RPNX 1204.. |  SSV M3.5x10-9511 |  STK-T15-9910 | 2,9 |

Copy Milling Tools



| Ordering Code | Item Designation | | Price | Master Insert* |
|--|------------------------|---|-------------|----------------|
| <i>SRT</i> <i>P3208 / P3210 / P3212</i> <i>P3216 / P3220 / P3225 / P3232</i> | | | <i>EURO</i> | |
| SM19898 | SRT P3208 D08 L110 d10 | - | 76 € | P3208 |
| SM39599 | SRT P3210 D10 L130 d10 | - | 76 € | P3210 |
| SM14886 | SRT P3210 D10 L130 d12 | - | 76 € | |
| SM14893 | SRT P3212 D12 L130 d12 | - | 82 € | P3212 |
| SM14909 | SRT P3216 D16 L175 d16 | - | 85 € | P3216 |
| SM14916 | SRT P3220 D20 L200 d20 | - | 97 € | P3220 |
| SM14923 | SRT P3225 D25 L200 d25 | - | 102 € | P3225 |
| SM14930 | SRT P3232 D32 L200 d32 | - | 109 € | P3232 |

| Size Designation | Master Insert* | Spare Parts | | |
|------------------|----------------|------------------------------|----------------------|----------------------|
| | | Screw | Torx Key | Allen Key |
| D08 | P3208 | TC170 3x0.5x7- 9801 | STK-T08- 9908 | - |
| D10 | P3210 | TC172 4x0.5x8- 9802 | STK-T15- 9910 | - |
| D12 | P3212 | TC174 5x0.5x9- 9803 | STK-T20- 9911 | - |
| D16 | P3216 | TC176 5x0.5x13- 9804 | STK-T20- 9911 | - |
| D20 | P3220 | TC178 5x0.5x17- 9805 | STK-T20- 9911 | - |
| D25 | P3225 | TC181 6x0.75x22- 9806 | - | SAK-AA3- 9902 |
| D32 | P3232 | TC184 8x0.75x28- 9807 | - | SAK-AA4- 9903 |



| Ordering Code | Item Designation | | Price | Master Insert* |
|--|-------------------------|---|-------------|----------------|
| <i>SRT</i> <i>XPHT16R0803 / 20R10T3 / 25R1204</i> | | | <i>EURO</i> | |
| SM60821 | SRT XP16 D16 C16 L150-H | ✓ | 112 € | XPHT16R0803 |
| SM60838 | SRT XP20 D20 C20 L150-H | ✓ | 118 € | XPHT20R10T3 |
| SM60845 | SRT XP25 D25 C25 L150-H | ✓ | 123 € | XPHT25R1204 |

| Size Designation | Master Insert* | Spare Parts | | |
|------------------|----------------|----------------------------|----------------------|--------------------|
| | | Screw | Torx Key | Screw Torque Value |
| D16 | XPHT16R0803 | SSV M2.5x6- 9505 | STK-T08- 9908 | 1,2 |
| D20 | XPHT20R10T3 | SSV M3.5x8- SC-9513 | STK-T10- 9909 | 2,9 |
| D25 | XPHT25R1204 | SSV-M4x9x5- 9528 | STK-T15- 9910 | 4,3 |



Copy Milling Tools

| Insert | | | BLMP 0603.. TGTC | BLMP 0904.. TGTC | BLMP 1105.. TGTC | LNMU 0303.. TNGLY | LNMU 06X5.. TNGLY | ENMU 1004.. DJT |
|--------------------|-----------------------|---|---|---|---|--|---|---|
| | | |  |  |  |  |  |  |
| Page | | | H227 | H227 | H227 | H228 | H228 | H229 |
| Dimeter Range (mm) | | | Ø16-50 | Ø25-63 | Ø40-66 | Ø16-50 | Ø32-63 | Ø16-63 |
| Approach Angle | | | -° | -° | -° | -° | -° | -° |
| Max. Cutting Depth | | | 1mm | 1.5mm | 2mm | 1mm | 1.5mm | 1.7mm |
| Holder Type | Endmills |  | ✓ Dia Range (mm) Ø16-32 | ✓ Dia Range (mm) Ø26-33 | - | ✓ Dia Range (mm) Ø16-33 | ✓ Dia Range (mm) Ø32-35 | ✓ Dia Range (mm) Ø16-32 |
| | Modular Mills |  | ✓ Dia Range (mm) Ø16-42 | ✓ Dia Range (mm) Ø25-40 | - | ✓ Dia Range (mm) Ø16-40 | - | ✓ Dia Range (mm) Ø16-25 |
| | Face Mills |  | ✓ Dia Range (mm) Ø40-50 | ✓ Dia Range (mm) Ø40-63 | ✓ Dia Range (mm) Ø40-66 | ✓ Dia Range (mm) Ø40-50 | ✓ Dia Range (mm) Ø50-63 | ✓ Dia Range (mm) Ø40-63 |
| Application | Face Milling |  | ✓ | ✓ | ✓ | ✓ | ✓ | ✓ |
| | Shoulder Milling |  | ✓ | ✓ | ✓ | ✓ | ✓ | ✓ |
| | Slot Milling |  | - | - | - | - | - | - |
| | Plunging |  | ✓ | ✓ | ✓ | ✓ | ✓ | ✓ |
| | Helical Interpolation |  | ✓ | ✓ | ✓ | ✓ | ✓ | ✓ |
| | Plunging |  | - | - | - | - | - | - |
| | Profile Milling |  | ✓ | ✓ | ✓ | ✓ | ✓ | ✓ |
| | | | | | | | | |
| | | | | | | | | |

| Insert | | ZPMT - YPHW - EP..1003 DJT | BNGX 10T3.. PRMT | ENMX 0604.. TNGLY | LPMT 0402.. KRLY | LPGT 0102.. KYCR | LOGU 0303.. KYCR | LOHT 0603.. SCO |
|--------------------|---|---|---|---|---|---|---|---|
| | |  |  |  |  |  |  |  |
| Page | | H229 | H231 | H230 | H234 | H234 | H232 | H233 |
| Dimeter Range (mm) | | Ø16-32 | Ø16-50 | Ø16-80 | Ø10-14 | Ø10-16 | Ø16-63 | Ø20-63 |
| Approach Angle | | -° | -° | -° | -° | -° | -° | -° |
| Max. Cutting Depth | | 1mm | 1.5mm | 0.9 - 1mm | 0.4mm | 0.5mm | 1mm | 0.9mm |
| Holder Type | Endmills  | ✓ Dia Range (mm) Ø16-32 | ✓ Dia Range (mm) Ø16-32 | ✓ Dia Range (mm) Ø16-33 | ✓ Dia Range (mm) Ø10-14 | ✓ Dia Range (mm) Ø10-16 | ✓ Dia Range (mm) Ø16-33 | ✓ Dia Range (mm) Ø20-32 |
| | Modular Mills  | ✓ Dia Range (mm) Ø16-25 | ✓ Dia Range (mm) Ø16-32 | ✓ Dia Range (mm) Ø16-42 | - | - | ✓ Dia Range (mm) Ø16-42 | ✓ Dia Range (mm) Ø20-32 |
| | Face Mills  | - | ✓ Dia Range (mm) Ø16-32 | ✓ Dia Range (mm) Ø40-80 | - | - | ✓ Dia Range (mm) Ø40-63 | ✓ Dia Range (mm) Ø40-63 |
| Application | Face Milling  | ✓ | ✓ | ✓ | ✓ | ✓ | ✓ | ✓ |
| | Shoulder Milling  | ✓ | ✓ | ✓ | ✓ | ✓ | ✓ | ✓ |
| | Slot Milling  | - | - | - | - | - | - | - |
| | Plunging  | ✓ | ✓ | ✓ | ✓ | ✓ | ✓ | ✓ |
| | Helical Interpolation  | ✓ | ✓ | ✓ | ✓ | ✓ | ✓ | ✓ |
| | Plunging  | - | - | - | - | - | - | - |
| | Profile Milling  | ✓ | ✓ | ✓ | ✓ | ✓ | ✓ | ✓ |
| | | | | | | | | |
| | | | | | | | | |















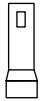

| Insert | | | WNMX 0603.. KRLY | WNMX 09T3.. KRLY | JOMT 06T2.. MTSBH | JOMT 0803.. MTSBH | JDM. 09T3.. MTSBH | JDM. 1204.. MTSBH |
|--------------------|-----------------------|---|---|---|---|--|---|---|
| | | |  |  |  |  |  |  |
| Page | | | H235 | H235 | H236 | H236 | H236 | H236 |
| Dimeter Range (mm) | | | Ø17-33 | Ø25-66 | Ø16-22 | Ø17-50 | Ø25-50 | Ø50-63 |
| Approach Angle | | | -° | -° | -° | -° | -° | -° |
| Max. Cutting Depth | | | 1mm | 1.5mm | 1mm | 1.5mm | 1.5mm | 2mm |
| Holder Type | Endmills |  | ✓ Dia Range (mm) Ø17-33 | ✓ Dia Range (mm) Ø25-40 | ✓ Dia Range (mm) Ø16-22 | ✓ Dia Range (mm) Ø17-26 | ✓ Dia Range (mm) Ø25-33 | - |
| | Modular Mills |  | ✓ Dia Range (mm) Ø20-32 | ✓ Dia Range (mm) Ø25-42 | - | ✓ Dia Range (mm) Ø25-35 | ✓ Dia Range (mm) Ø25-35 | - |
| | Face Mills |  | - | ✓ Dia Range (mm) Ø40-66 | - | ✓ Dia Range (mm) Ø40-50 | ✓ Dia Range (mm) Ø40-50 | ✓ Dia Range (mm) Ø50-63 |
| Application | Face Milling |  | ✓ | ✓ | ✓ | ✓ | ✓ | ✓ |
| | Shoulder Milling |  | ✓ | ✓ | ✓ | ✓ | ✓ | ✓ |
| | Slot Milling |  | - | - | - | - | - | - |
| | Plunging |  | ✓ | ✓ | ✓ | ✓ | ✓ | ✓ |
| | Helical Interpolation |  | ✓ | ✓ | ✓ | ✓ | ✓ | ✓ |
| | Plunging |  | - | - | - | - | - | - |
| | Profile Milling |  | ✓ | ✓ | ✓ | ✓ | ✓ | ✓ |
| | | | | | | | | |
| | | | | | | | | |

| Insert | | | WDMT 0603.. SMTM | WDMT 0804.. SMTM | WDMT 1204.. SMTM | WDMW 06T3.. DJT | WDMW 0805.. DJT | WDMW 10X6.. DJT |
|--------------------|-----------------------|---|---|---|---|---|---|---|
| | | |  |  |  |  |  |  |
| Page | | | H237 | H237 | H237 | H238 | H238 | H238 |
| Dimeter Range (mm) | | | Ø16-22 | Ø20-50 | Ø50-63 | Ø25-50 | Ø50-63 | Ø125-160 |
| Approach Angle | | | -° | -° | -° | -° | -° | -° |
| Max. Cutting Depth | | | 1mm | 1.5mm | 2mm | 1.5mm | 2mm | 2.5mm |
| Holder Type | Endmills |  | ✓ Dia Range (mm) Ø16-22 | ✓ Dia Range (mm) Ø20-33 | - | ✓ Dia Range (mm) Ø25-32 | - | - |
| | Modular Mills |  | - | ✓ Dia Range (mm) Ø25-35 | - | - | - | - |
| | Face Mills |  | - | ✓ Dia Range (mm) Ø40-50 | ✓ Dia Range (mm) Ø50-63 | ✓ Dia Range (mm) Ø40-50 | ✓ Dia Range (mm) Ø50-63 | ✓ Dia Range (mm) Ø125-160 |
| Application | Face Milling |  | ✓ | ✓ | ✓ | ✓ | ✓ | ✓ |
| | Shoulder Milling |  | ✓ | ✓ | ✓ | ✓ | ✓ | ✓ |
| | Slot Milling |  | - | - | - | - | - | - |
| | Plunging |  | ✓ | ✓ | ✓ | ✓ | ✓ | ✓ |
| | Helical Interpolation |  | ✓ | ✓ | ✓ | ✓ | ✓ | ✓ |
| | Plunging |  | - | - | - | - | - | - |
| | Profile Milling |  | ✓ | ✓ | ✓ | ✓ | ✓ | ✓ |
| | | | | | | | | |

| Insert | | | WOM. 04T2.. DJT | WXCU 0705.. | WOEJ 0905.. KNMT | 218.21 SCO | WNMU 0907.. DJT | SDMT 09T3.. ZCC |
|--------------------|-----------------------|---|---|---|---|--|---|---|
| | | |  |  |  |  |  |  |
| Page | | | H238 | H239 | H239 | H239 | H240 | H240 |
| Dimeter Range (mm) | | | Ø16-20 | Ø40-63 | Ø40-63 | Ø50-80 | Ø63-66 | Ø25-63 |
| Approach Angle | | | -° | -° | -° | -° | -° | -° |
| Max. Cutting Depth | | | 1.2mm | 1.5mm | 1.6mm | 1.8mm | 2.25mm | 1.4mm |
| Holder Type | Endmills |  | ✓ Dia Range (mm) Ø16-20 | - | - | - | - | ✓ Dia Range (mm) Ø25-35 |
| | Modular Mills |  | ✓ Dia Range (mm) Ø16-20 | - | - | - | - | ✓ Dia Range (mm) Ø25-40 |
| | Face Mills |  | - | ✓ Dia Range (mm) Ø40-63 | ✓ Dia Range (mm) Ø40-63 | ✓ Dia Range (mm) Ø50-80 | ✓ Dia Range (mm) Ø63-66 | ✓ Dia Range (mm) Ø40-63 |
| Application | Face Milling |  | ✓ | ✓ | ✓ | ✓ | ✓ | ✓ |
| | Shoulder Milling |  | ✓ | ✓ | ✓ | ✓ | ✓ | ✓ |
| | Slot Milling |  | - | - | - | - | - | - |
| | Plunging |  | ✓ | ✓ | ✓ | ✓ | ✓ | ✓ |
| | Helical Interpolation |  | ✓ | ✓ | ✓ | ✓ | ✓ | ✓ |
| | Plunging |  | - | - | - | - | - | - |
| | Profile Milling |  | ✓ | ✓ | ✓ | ✓ | ✓ | ✓ |
| | | | | | | | | |
| | | | | | | | | |

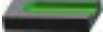
| Insert | | | SDMT 1204.. ZCC | SDKX 0904.. LMN | SDKX 1205.. LMN | XLPX 0603.. CRTZ | XLPX 09T3.. CRTZ | R210.09 SDV |
|--------------------|-----------------------|---|---|---|---|--|---|---|
| | | |  |  |  |  |  |  |
| Page | | | H240 | H241 | H241 | H242 | H242 | H241 |
| Dimeter Range (mm) | | | Ø50-63 | Ø25-63 | Ø50-63 | Ø16-22 | Ø25-63 | Ø25-63 |
| Approach Angle | | | -° | -° | -° | -° | -° | -° |
| Max. Cutting Depth | | | 1.8mm | 1.4mm | 1.8mm | 1mm | 1.2mm | 1.2mm |
| Holder Type | Endmills |  | - | ✓ Dia Range (mm) Ø25-32 | - | ✓ Dia Range (mm) Ø16-21 | ✓ Dia Range (mm) Ø25-26 | ✓ Dia Range (mm) Ø25-33 |
| | Modular Mills |  | - | ✓ Dia Range (mm) Ø25-40 | - | ✓ Dia Range (mm) Ø16-22 | ✓ Dia Range (mm) Ø25-42 | ✓ Dia Range (mm) Ø25-35 |
| | Face Mills |  | ✓ Dia Range (mm) Ø50-63 | ✓ Dia Range (mm) Ø40-63 | ✓ Dia Range (mm) Ø50-63 | - | ✓ Dia Range (mm) Ø40-63 | ✓ Dia Range (mm) Ø40-63 |
| Application | Face Milling |  | ✓ | ✓ | ✓ | ✓ | ✓ | ✓ |
| | Shoulder Milling |  | ✓ | ✓ | ✓ | ✓ | ✓ | ✓ |
| | Slot Milling |  | - | - | - | - | - | - |
| | Plunging |  | ✓ | ✓ | ✓ | ✓ | ✓ | ✓ |
| | Helical Interpolation |  | ✓ | ✓ | ✓ | ✓ | ✓ | ✓ |
| | Plunging |  | - | - | - | - | - | - |
| | Profile Milling |  | ✓ | ✓ | ✓ | ✓ | ✓ | ✓ |
| | | | | | | | | |
| | | | | | | | | |

| Insert | | SWMT 0904.. TNGLY | SP.. 1004.. DJT | SP.. 1405.. DJT | SPEW 2006.. DJT | SOMT 1004.. KYCR | SOMT 1405.. KYCR |
|--------------------|-----------------------|---|---|---|--|---|--|
| | |  |  |  |  |  |  |
| Page | | H243 | H243 | H244 | H244 | H245 | H245 |
| Dimeter Range (mm) | | Ø25-32 | Ø25-63 | Ø50-63 | Ø50-63 | Ø32-63 | Ø63-160 |
| Approach Angle | | -° | -° | -° | -° | -° | -° |
| Max. Cutting Depth | | 1mm | 1.6mm | 2.05mm | 2.45mm | 1.2mm | 2.7mm |
| Holder Type | Endmills |  Dia Range (mm) Ø16-20 ✓ |  Dia Range (mm) Ø25-32 ✓ | - | - | - | - |
| | Modular Mills |  Dia Range (mm) Ø16-20 ✓ |  Dia Range (mm) Ø25-32 ✓ | - | - | - | - |
| | Face Mills |  Dia Range (mm) Ø40-63 ✓ |  Dia Range (mm) Ø40-63 ✓ |  Dia Range (mm) Ø50-63 ✓ |  Dia Range (mm) Ø50-63 ✓ |  Dia Range (mm) Ø63-66 ✓ |  Dia Range (mm) Ø63-160 ✓ |
| Application | Face Milling |  ✓ |  ✓ |  ✓ |  ✓ |  ✓ |  ✓ |
| | Shoulder Milling |  ✓ |  ✓ |  ✓ |  ✓ |  ✓ |  ✓ |
| | Slot Milling |  - |  - |  - |  - |  - |  - |
| | Plunging |  ✓ |  ✓ |  ✓ |  ✓ |  ✓ |  ✓ |
| | Helical Interpolation |  ✓ |  ✓ |  ✓ |  ✓ |  ✓ |  ✓ |
| | Plunging |  - |  - |  - |  - |  - |  - |
| | Profile Milling |  ✓ |  ✓ |  ✓ |  ✓ |  ✓ |  ✓ |

| Insert | | | ZDCW 09T3.. PRMT | ZDCW 1204.. PRMT | SPKT 08T3.. PLBT | XPLT 0603.. KNMTL | XDLT 0904.. KNMTL | SQMU 1206.. TNGLY |
|--------------------|-----------------------|---|---|---|---|---|---|---|
| | | |  |  |  |  |  |  |
| Page | | | H246 | H246 | H247 | H248 | H248 | H248 |
| Dimeter Range (mm) | | | Ø25-50 | Ø25-63 | Ø20-63 | Ø16-32 | Ø25-63 | Ø50-63 |
| Approach Angle | | | -° | -° | -° | -° | -° | -° |
| Max. Cutting Depth | | | 1.3mm | 1.4mm | 1.5mm | 0.9mm | 1.45mm | 2mm |
| Holder Type | Endmills |  | ✓ Dia Range (mm) Ø25-32 | - | ✓ Dia Range (mm) Ø20-32 | ✓ Dia Range (mm) Ø16-32 | ✓ Dia Range (mm) Ø25-40 | - |
| | Modular Mills |  | ✓ Dia Range (mm) Ø25-35 | - | ✓ Dia Range (mm) Ø25-42 | - | - | - |
| | Face Mills |  | ✓ Dia Range (mm) Ø40-50 | ✓ Dia Range (mm) Ø50-63 | ✓ Dia Range (mm) Ø40-63 | - | ✓ Dia Range (mm) Ø40-63 | ✓ Dia Range (mm) Ø50-63 |
| Application | Face Milling |  | ✓ | ✓ | ✓ | ✓ | ✓ | ✓ |
| | Shoulder Milling |  | ✓ | ✓ | ✓ | ✓ | ✓ | ✓ |
| | Slot Milling |  | - | - | - | - | - | - |
| | Plunging |  | ✓ | ✓ | ✓ | ✓ | ✓ | ✓ |
| | Helical Interpolation |  | ✓ | ✓ | ✓ | ✓ | ✓ | ✓ |
| | Plunging |  | - | - | - | - | - | - |
| | Profile Milling |  | ✓ | ✓ | ✓ | ✓ | ✓ | ✓ |
| | | | | | | | | |



| Ordering Code | Item Designation | | Price | Master Insert* |
|---|-----------------------------|---|-------|----------------|
| HST BLMP 0603.. / 0904.. / 1105.. | | | EURO | |
| SM34921 | HST BL06 D16 W16 L120 Z02-H | ✓ | 94 € | BLMP 0603.. |
| SM00685 | HST BL06 D17 W16 L150 Z02-H | ✓ | 103 € | |
| SM34938 | HST BL06 D20 W20 L150 Z03-H | ✓ | 101 € | |
| SM34983 | HST BL06 D20 C20 L200 Z03 | - | 115 € | |
| SM00692 | HST BL06 D21 W20 L150 Z03-H | ✓ | 111 € | |
| SM34945 | HST BL06 D25 W25 L150 Z04-H | ✓ | 122 € | |
| SM34976 | HST BL06 D25 C25 L200 Z04 | - | 137 € | |
| SM00708 | HST BL06 D26 W25 L150 Z04-H | ✓ | 134 € | |
| SM34952 | HST BL06 D32 W32 L150 Z05-H | ✓ | 130 € | |
| SM34990 | HST BL06 D32 C32 L200 Z05 | - | 144 € | |
| SM60807 | HST BL06 D35 W32 L150 Z05-H | ✓ | 132 € | BLMP 0904.. |
| SM58859 | HST BL09 D25 W25 L150 Z03-H | ✓ | 146 € | |
| SM58866 | HST BL09 D26 W25 L150 Z03-H | ✓ | 146 € | |
| SM58873 | HST BL09 D32 W32 L150 Z04-H | ✓ | 157 € | |
| SM58880 | HST BL09 D33 W32 L150 Z04-H | ✓ | 157 € | BLMP 1105.. |
| SM59030 | HST BL11 D33 W32 L150 Z02-H | ✓ | 151 € | |
| SM59047 | HST BL11 D35 W32 L150 Z03-H | ✓ | 151 € | |



| Ordering Code | Item Designation | | Price | Master Insert* |
|--------------------------------|----------------------------|---|-------|----------------|
| MHT BLMP 0603 / 0904 | | | EURO | |
| SM36673 | MHT BL06 D16 M08 L25 Z02-H | ✓ | 87 € | BLMP 0603.. |
| SM36697 | MHT BL06 D20 M10 L30 Z03-H | ✓ | 103 € | |
| SM36710 | MHT BL06 D25 M12 L35 Z04-H | ✓ | 106 € | |
| SM36727 | MHT BL06 D32 M16 L43 Z05-H | ✓ | 110 € | |
| SM47730 | MHT BL06 D35 M16 L43 Z05-H | ✓ | 110 € | |
| SM00838 | MHT BL06 D40 M16 L43 Z06-H | ✓ | 132 € | |
| SM56633 | MHT BL06 D42 M16 L43 Z06-H | ✓ | 134 € | BLMP 0904.. |
| SM58897 | MHT BL09 D25 M12 L35 Z03-H | ✓ | 111 € | |
| SM58903 | MHT BL09 D32 M16 L43 Z04-H | ✓ | 116 € | |
| SM58910 | MHT BL09 D35 M16 L43 Z04-H | ✓ | 116 € | |
| SM58927 | MHT BL09 D40 M16 L43 Z05-H | ✓ | 132 € | |



| Ordering Code | Item Designation | | Price | Master Insert* |
|---|------------------------|---|-------|----------------|
| HTK BLMP 0603.. / 0904.. / 1105.. | | | EURO | |
| SM38967 | HTK BL06 D40 A16 Z06-H | ✓ | 106 € | BLMP 0603.. |
| SM33177 | HTK BL06 D50 A22 Z07-H | ✓ | 128 € | BLMP 0904.. |
| SM28050 | HTK BL09 D40 A16 Z05-H | ✓ | 94 € | |
| SM28043 | HTK BL09 D50 A22 Z06-H | ✓ | 114 € | |
| SM22607 | HTK BL09 D63 A22 Z07-H | ✓ | 128 € | BLMP 1105.. |
| SM54561 | HTK BL11 D40 A16 Z04-H | ✓ | 94 € | |
| SM54578 | HTK BL11 D50 A22 Z05-H | ✓ | 114 € | |
| SM54585 | HTK BL11 D52 A22 Z05-H | ✓ | 129 € | |
| SM54592 | HTK BL11 D63 A22 Z06-H | ✓ | 140 € | |
| SM54608 | HTK BL11 D66 A27 Z06-H | ✓ | 157 € | |

Cooling mounting screw is optional / See Page 294 for cooling mounting screws.
İçten su vermeli montaj vidaları opsiyoneldir. / Bkz. Sayfa 294 İçten su vermeli montaj vidaları için.

*Suitable Insert brand is TGTC.

| Size Designation | Master Insert* | Spare Parts | | |
|------------------|----------------|--------------------|--------------|---------------------------|
| | | Screw | Torx Key | Screw Torque Value N-m |
| D16 - D42 | BLMP 0603.. | SSV M2.5x6-9505 | STK-T08-9908 | 1,2 |
| D50 | | SSV M2.5x7-9507 | | |
| D25 - D63 | BLMP 0904.. | SSV M3.5x8-SC-9513 | STK-T10-9909 | 2,9 |
| D32 - D66 | BLMP 1105.. | SSV M5x13-9519 | STK-T20-9911 | 8,5 |



| Ordering Code | Item Designation | | Price | Master Insert* |
|-----------------------------------|-----------------------------|---|-------|----------------|
| HST LNMU 0303.. / 06X5 | | | EURO | |
| SM45507 | HST LN03 D16 W16 L150 Z02-H | ✓ | 110 € | LNMU 0303.. |
| SM01385 | HST LN03 D17 W16 L150 Z02-H | ✓ | 110 € | |
| SM52871 | HST LN03 D17 C16 L200 Z02 | ✓ | 134 € | |
| SM49741 | HST LN03 D18 W16 L150 Z02-H | ✓ | 110 € | |
| SM45514 | HST LN03 D20 W20 L150 Z03-H | ✓ | 121 € | |
| SM52833 | HST LN03 D21 W20 L150 Z03-H | ✓ | 121 € | |
| SM52888 | HST LN03 D21 C20 L200 Z03 | ✓ | 146 € | |
| SM49758 | HST LN03 D22 W20 L150 Z03-H | ✓ | 123 € | |
| SM45521 | HST LN03 D25 W25 L150 Z04-H | ✓ | 146 € | |
| SM52840 | HST LN03 D26 W25 L150 Z04-H | ✓ | 146 € | |
| SM52895 | HST LN03 D26 C25 L200 Z04 | ✓ | 168 € | |
| SM52857 | HST LN03 D32 W32 L150 Z05-H | ✓ | 174 € | |
| SM52864 | HST LN03 D33 W32 L150 Z05-H | ✓ | 174 € | |
| SM52901 | HST LN03 D33 C32 L200 Z05 | ✓ | 196 € | |
| SM45538 | HST LN06 D32 W32 L150 Z02-H | ✓ | 153 € | LNMU 06X5.. |
| SM45545 | HST LN06 D35 W32 L150 Z02-H | ✓ | 153 € | |



| Ordering Code | Item Designation | | Price | Master Insert* |
|----------------------------|----------------------------|---|-------|----------------|
| MHT LNMU 0303.. | | | EURO | |
| SM45552 | MHT LN03 D16 M08 L25 Z02-H | ✓ | 101 € | LNMU 0303.. |
| SM45569 | MHT LN03 D20 M10 L30 Z03-H | ✓ | 119 € | |
| SM45576 | MHT LN03 D25 M12 L35 Z04-H | ✓ | 124 € | |
| SM51959 | MHT LN03 D32 M16 L43 Z05-H | ✓ | 129 € | |
| SM00272 | MHT LN03 D35 M16 L43 Z05-H | ✓ | 129 € | |
| SM60401 | MHT LN03 D40 M16 L43 Z05-H | ✓ | 131 € | |
| SM51966 | MHT LN03 D40 M16 L43 Z06-H | ✓ | 142 € | |
| SM00265 | MHT LN03 D42 M16 L43 Z06-H | ✓ | 142 € | |















| Ordering Code | Item Designation | | Price | Master Insert* |
|----------------------------|------------------------|---|-------|----------------|
| HTK LNMU 0303.. | | | EURO | |
| SM45460 | HTK LN03 D40 A16 Z05-H | ✓ | 115 € | LNMU 0303.. |
| SM45477 | HTK LN03 D50 A22 Z07-H | ✓ | 139 € | |
| SM45484 | HTK LN06 D50 A22 Z04-H | ✓ | 139 € | LNMU 06X5.. |
| SM50280 | HTK LN06 D63 A22 Z05-H | ✓ | 169 € | |







Cooling mounting screw is optional / See Page 294 for cooling mounting screws.
İçten su vermeli montaj vidaları opsiyoneldir. / Bkz. Sayfa 294 İçten su vermeli montaj vidaları için.



*Suitable Insert brand is TNGLY.







| Size Designation | Master Insert* | Spare Parts | | |
|------------------|----------------|--------------------|--------------|--------------------|
| | | Screw | Torx Key | Screw Torque Value |
| D16 - D18 | | | | |
| D20 - D50 | | SSV M2.5x6-9505 | | |
| D32 - D63 | LNMU 06X5.. | SSV M2.5x7-9507 | STK-T08-9908 | 1,2 |
| | LNMU 06X5.. | SSV M5x13-9519 | STK-T20-9911 | 8,5 |







|  | Ordering Code | Item Designation | | Price | Master Insert* | |
|---|-----------------------------|---|---|---|----------------|---|
| | HST ENMU 1004.. | | |  | EURO |  |
| | SM47273 | HST EN10 D16 W16 L150 Z02-H |  | 110 € | ENMU 1004.. | |
| | SM47280 | HST EN10 D20 W20 L150 Z03-H |  | 121 € | | |
| | SM47297 | HST EN10 D25 W25 L150 Z04-H |  | 146 € | | |
| SM47303 | HST EN10 D32 W32 L150 Z05-H |  | 153 € | | | |





|  | Ordering Code | Item Designation | | Price | Master Insert* | |
|---|------------------------|----------------------------|---|---|----------------|---|
| | MHT ENMU 1004.. | | |  | EURO |  |
| | SM47426 | MHT EN10 D16 M08 L25 Z02-H |  | 101 € | ENMU 1004.. | |
| | SM47433 | MHT EN10 D20 M10 L30 Z03-H |  | 119 € | | |
| | SM47440 | MHT EN10 D25 M12 L35 Z04-H |  | 124 € | | |

|  | Ordering Code | Item Designation | | Price | Master Insert* | |
|---|------------------------|------------------------|--|---|----------------|---|
| | HTK ENMU 1004.. | | |  | EURO |  |
| | SM47242 | HTK EN10 D40 A16 Z05-H |  | 115 € | ENMU 1004.. | |
| | SM47259 | HTK EN10 D50 A22 Z07-H |  | 139 € | | |
| | SM47266 | HTK EN10 D63 A22 Z09-H |  | 169 € | | |

| Size Designation | Master Insert* | Spare Parts | | |
|------------------|---|--|---|---|
| |  | Screw  | Torx Key  | Screw Torque Value  N-m |
| D16 - D20 | ENMU 1004.. | SSV M2.5x6-9505 | STK-T08-9908 | 1,2 |
| D25 - D63 | | SSV M2.5x7-9506 | | |

|  | Ordering Code | Item Designation | | Price | Master Insert* | |
|---|--------------------------------------|---|---|---|---------------------------|---|
| | HST ZPMT / YPHW / EP.. 1003.. | | |  | EURO |  |
| | SM47358 | HST(90) ZP10 D16 W16 L150 Z02-H |  | 110 € | ZPMT / YPHW / EP.. 1003.. | |
| | SM47365 | HST(90) ZP10 D20 W20 L150 Z03-H |  | 121 € | | |
| | SM47372 | HST(90) ZP10 D25 W25 L150 Z04-H |  | 146 € | | |
| SM47389 | HST(90) ZP10 D32 W32 L150 Z05-H |  | 153 € | | | |

|  | Ordering Code | Item Designation | | Price | Master Insert* | |
|---|--------------------------------------|--------------------------------|---|---|---------------------------|---|
| | MHT ZPMT / YPHW / EP.. 1003.. | | |  | EURO |  |
| | SM47457 | MHT(90) ZP10 D16 M08 L25 Z02-H |  | 101 € | ZPMT / YPHW / EP.. 1003.. | |
| | SM47464 | MHT(90) ZP10 D20 M10 L30 Z03-H |  | 119 € | | |
| | SM47471 | MHT(90) ZP10 D25 M12 L35 Z04-H |  | 124 € | | |

| Size Designation | Master Insert* | Spare Parts | | |
|------------------|---|--|---|---|
| |  | Screw  | Torx Key  | Screw Torque Value  N-m |
| D16 - D20 | ZPMT / YPHW / EP.. 1003.. | SSV M2.5x6-9505 | STK-T08-9908 | 1,2 |
| D25 - D32 | | SSV M2.5x7-9507 | | |

Cooling mounting screw is optional / See Page 294 for cooling mounting screws.
İçten su vermeli montaj vidaları opsiyoneldir. / Bkz. Sayfa 294 İçten su vermeli montaj vidaları için.

*Suitable Insert brand is DJT.



| Ordering Code | Item Designation | | Price | Master Insert* |
|------------------------|-----------------------------|---|-------|----------------|
| HST ENMX 0604.. | | | EURO | |
| SM58170 | HST EN06 D16 W16 L150 Z02-H | ✓ | 119 € | ENMX 0604.. |
| SM58187 | HST EN06 D17 W16 L150 Z02-H | ✓ | 119 € | |
| SM58194 | HST EN06 D20 W20 L150 Z03-H | ✓ | 130 € | |
| SM58200 | HST EN06 D20 C20 L200 Z03 | - | 135 € | |
| SM58217 | HST EN06 D21 W20 L150 Z03-H | ✓ | 130 € | |
| SM58224 | HST EN06 D21 C20 L200 Z03 | - | 135 € | |
| SM58231 | HST EN06 D25 W25 L150 Z04-H | ✓ | 160 € | |
| SM58248 | HST EN06 D25 C25 L200 Z04 | - | 165 € | |
| SM58255 | HST EN06 D26 W25 L150 Z04-H | ✓ | 160 € | |
| SM58262 | HST EN06 D26 C25 L200 Z04 | - | 165 € | |
| SM58279 | HST EN06 D32 C32 L200 Z05 | - | 176 € | |
| SM58286 | HST EN06 D33 C32 L200 Z05 | - | 176 € | |



| Ordering Code | Item Designation | | Price | Master Insert* |
|------------------------|----------------------------|---|-------|----------------|
| HST ENMX 0604.. | | | EURO | |
| SM58293 | MHT EN06 D16 M08 L25 Z02-H | ✓ | 110 € | ENMX 0604.. |
| SM58309 | MHT EN06 D20 M10 L30 Z03-H | ✓ | 122 € | |
| SM58316 | MHT EN06 D25 M12 L35 Z04-H | ✓ | 134 € | |
| SM58323 | MHT EN06 D32 M16 L43 Z05-H | ✓ | 149 € | |
| SM58330 | MHT EN06 D35 M16 L43 Z05-H | ✓ | 149 € | |
| SM58347 | MHT EN06 D42 M16 L43 Z05-H | ✓ | 155 € | |



| Ordering Code | Item Designation | | Price | Master Insert* |
|------------------------|------------------------|---|-------|----------------|
| HTK ENMX 0604.. | | | EURO | |
| SM58354 | HTK EN06 D40 A16 Z05-H | ✓ | 130 € | ENMX 0604.. |
| SM58361 | HTK EN06 D50 A22 Z06-H | ✓ | 150 € | |
| SM58378 | HTK EN06 D63 A22 Z07-H | ✓ | 183 € | |
| SM58385 | HTK EN06 D80 A27 Z08-H | ✓ | 183 € | |

Cooling mounting screw is optional / See Page 294 for cooling mounting screws.
İçten su vermeli montaj vidaları opsiyoneldir. / Bkz. Sayfa 294 içten su vermeli montaj vidaları için.

*Suitable Insert brand is YG-1.

High Feed Milling Tools

| Size Designation | Master Insert* | Spare Parts | | |
|------------------|----------------|--------------------|--------------|---------------------------|
| | | Screw | Torx Key | Screw Torque Value N-m |
| D16 - D20 | ENMX 0604.. | SSV M2.5x6-9505 | STK-T08-9908 | 1,2 |
| D25 - D80 | | SSV M2.5x7-9507 | | |



| Ordering Code | Item Designation | | Price | Master Insert* |
|---------------|-----------------------------|---|-------|----------------|
| | HST BNGX 10T3.. | | EURO | |
| SM46375 | HST BN10 D16 W16 L150 Z02-H | ✓ | 110 € | BNGX 10T3.. |
| SM46382 | HST BN10 D20 W20 L150 Z03-H | ✓ | 121 € | |
| SM46399 | HST BN10 D25 W25 L150 Z04-H | ✓ | 146 € | |
| SM46405 | HST BN10 D32 W32 L150 Z05-H | ✓ | 153 € | |



| Ordering Code | Item Designation | | Price | Master Insert* |
|---------------|----------------------------|---|-------|----------------|
| | MHT BNGX 10T3.. | | EURO | |
| SM46450 | MHT BN10 D16 M08 L25 Z02-H | ✓ | 101 € | BNGX 10T3.. |
| SM46467 | MHT BN10 D20 M10 L30 Z03-H | ✓ | 119 € | |
| SM46474 | MHT BN10 D25 M12 L35 Z04-H | ✓ | 124 € | |
| SM46481 | MHT BN10 D32 M16 L43 Z05-H | ✓ | 134 € | |



| Ordering Code | Item Designation | | Price | Master Insert* |
|---------------|------------------------|---|-------|----------------|
| | HTK BNGX 10T3.. | | EURO | |
| SM43558 | HTK BN10 D40 A16 Z06-H | ✓ | 115 € | BNGX 10T3.. |
| SM43565 | HTK BN10 D50 A22 Z07-H | ✓ | 139 € | |

Cooling mounting screw is optional / See Page 294 for cooling mounting screws.

İçten su vermeli montaj vidaları opsiyoneldir. / Bkz. Sayfa 294 İçten su vermeli montaj vidaları için.

*Suitable Insert brand is PRMT.

| Size Designation | Master Insert* | Spare Parts | | |
|------------------|----------------|-----------------|--------------|--------------------|
| | | Screw | Torx Key | Screw Torque Value |
| D16 - D20 | BNGX 10T3.. | | | |
| D25 - D50 | | SSV M2.5x6-9505 | STK-T08-9908 | 1,2 |
| | | SSV M2.5x7-9507 | | |





| Ordering Code | Item Designation | | Price | Master Insert* |
|------------------------|-----------------------------|--|-------------|----------------|
| HST LOGU 0303.. | | | <i>EURO</i> | |
| SM52574 | HST LG03 D16 W16 L100 Z02-H | | 90 € | LOGU 0303.. |
| SM27442 | HST LG03 D16 W16 L150 Z02-H | | 93 € | |
| SM52581 | HST LG03 D17 W16 L150 Z02-H | | 93 € | |
| SM52598 | HST LG03 D20 W20 L100 Z03-H | | 95 € | |
| SM27480 | HST LG03 D20 W20 L150 Z03-H | | 101 € | |
| SM01972 | HST LG03 D20 W20 L150 Z04-H | | 109 € | |
| SM37991 | HST LG03 D21 W20 L150 Z03-H | | 101 € | |
| SM52611 | HST LG03 D21 C20 L200 Z03 | | - | |
| SM27503 | HST LG03 D22 W20 L150 Z03-H | | 101 € | |
| SM52628 | HST LG03 D25 W25 L100 Z04-H | | 112 € | |
| SM27527 | HST LG03 D25 W25 L150 Z04-H | | 121 € | |
| SM01989 | HST LG03 D25 W25 L150 Z05-H | | 129 € | |
| SM52642 | HST LG03 D25 C25 L200 Z04 | | - | |
| SM52659 | HST LG03 D26 W25 L150 Z04-H | | 131 € | |
| SM27541 | HST LG03 D32 W32 L150 Z05-H | | 129 € | |
| SM52666 | HST LG03 D32 C32 L200 Z05 | | - | |
| SM52673 | HST LG03 D33 W32 L150 Z05-H | | 129 € | |



| Ordering Code | Item Designation | | Price | Master Insert* |
|------------------------|----------------------------|--|-------------|----------------|
| MHT LOGU 0303.. | | | <i>EURO</i> | |
| SM37144 | MHT LG03 D16 M08 L25 Z02-H | | 90 € | LOGU 0303.. |
| SM29996 | MHT LG03 D20 M10 L30 Z03-H | | 106 € | |
| SM00760 | MHT LG03 D20 M10 L30 Z04-H | | 118 € | |
| SM29989 | MHT LG03 D25 M12 L35 Z04-H | | 112 € | |
| SM00715 | MHT LG03 D25 M12 L35 Z05-H | | 120 € | |
| SM27565 | MHT LG03 D32 M16 L43 Z05-H | | 114 € | |
| SM00722 | MHT LG03 D32 M16 L43 Z06-H | | 123 € | |
| SM37151 | MHT LG03 D35 M16 L43 Z05-H | | 119 € | |
| SM01132 | MHT LG03 D42 M16 L43 Z05-H | | 139 € | |
| SM52697 | MHT LG03 D42 M16 L43 Z06-H | | 151 € | |



| Ordering Code | Item Designation | | Price | Master Insert* |
|------------------------|------------------------|--|-------------|----------------|
| HTK LOGU 0303.. | | | <i>EURO</i> | |
| SM33146 | HTK LG03 D40 A16 Z05-H | | 115 € | LOGU 0303.. |
| SM52550 | HTK LG03 D40 A16 Z06-H | | 123 € | |
| SM60661 | HTK LG03 D40 A16 Z07-H | | 157 € | |
| SM52567 | HTK LG03 D50 A22 Z06-H | | 131 € | |
| SM29330 | HTK LG03 D50 A22 Z07-H | | 139 € | |
| SM60678 | HTK LG03 D50 A22 Z08-H | | 157 € | |
| SM33153 | HTK LG03 D63 A22 Z09-H | | 169 € | |

Cooling mounting screw is optional / See Page 294 for cooling mounting screws.
İçten su vermeli montaj vidaları opsiyoneldir. / Bkz. Sayfa 294 İçten su vermeli montaj vidaları için.

*Suitable Insert brand is KYCR.

| Size Designation | Master Insert* | Spare Parts | | |
|------------------|----------------|------------------|--------------|--------------------|
| | | Screw | Torx Key | Screw Torque Value |
| D16 - D63 | | | | N-m |
| | LOGU 0303.. | SSV M3x6 LG-9509 | STK-T08-9908 | 1,9 |



| Ordering Code | Item Designation | | Price | Master Insert* |
|---------------|-----------------------------|---|-------|----------------|
| | HST LOHT 0603.. | | EURO | |
| SM58774 | HST LO06 D20 W20 L150 Z02-H | ✓ | 101 € | LOHT 0603.. |
| SM58781 | HST LO06 D21 W20 L150 Z02-H | ✓ | 101 € | |
| SM58798 | HST LO06 D25 W25 L150 Z03-H | ✓ | 109 € | |
| SM58804 | HST LO06 D26 W25 L150 Z03-H | ✓ | 109 € | |
| SM58811 | HST LO06 D32 W32 L150 Z04-H | ✓ | 127 € | |



| Ordering Code | Item Designation | | Price | Master Insert* |
|---------------|----------------------------|---|-------|----------------|
| | MHT LOHT 0603.. | | EURO | |
| SM58828 | MHT LO06 D20 M10 L30 Z02-H | ✓ | 106 € | LOHT 0603.. |
| SM58835 | MHT LO06 D25 M12 L35 Z03-H | ✓ | 112 € | |
| SM58842 | MHT LO06 D32 M16 L43 Z04-H | ✓ | 118 € | |



| Ordering Code | Item Designation | | Price | Master Insert* |
|---------------|------------------------|---|-------|----------------|
| | HTK LOHT 0603.. | | EURO | |
| SM56565 | HTK LO06 D40 A16 Z06-H | ✓ | 123 € | LOHT 0603.. |
| SM56572 | HTK LO06 D50 A22 Z07-H | ✓ | 139 € | |
| SM56589 | HTK LO06 D52 A22 Z07-H | ✓ | 151 € | |
| SM56596 | HTK LO06 D63 A22 Z08-H | ✓ | 162 € | |

Cooling mounting screw is optional / See Page 294 for cooling mounting screws.
İçten su vermeli montaj vidaları opsiyoneldir. / Bkz. Sayfa 294 İçten su vermeli montaj vidaları için.

*Suitable Insert brand is SCO.

| Size Designation | Master Insert* | Spare Parts | | |
|------------------|----------------|---------------------|------------------|--------------------|
| | | Screw | Torx Key | Screw Torque Value |
| D20 - D63 | LOHT 0603.. | SSV M2.5x7-9506 | STK-T08-9908 | N·m 1,2 |



| Ordering Code | Item Designation | | Price | Master Insert* |
|--------------------------------------|-----------------------------|---|-------|----------------|
| <i>HST LPMT / LPMW / LPEW 0402..</i> | | | EURO | |
| SM47396 | HST LP04 D10 C10 L120 Z02-H | ✓ | 109 € | LP.. 0402.. |
| SM47402 | HST LP04 D12 C12 L120 Z02-H | ✓ | 115 € | |
| SM47419 | HST LP04 D14 C12 L120 Z03-H | ✓ | 127 € | |

*Suitable Insert brand is KRLY.

| Size Designation | Master Insert* | Spare Parts | | |
|------------------|----------------|------------------------|------------------|--------------------|
| | | Screw | Torx Key | Screw Torque Value |
| D10 - D14 | LP.. 0402.. | SSV M1.8x4-9501 | STK-T06-9906 | N-m 0,6 |



| Ordering Code | Item Designation | | Price | Master Insert* |
|----------------------------------|-----------------------------|---|-------|------------------|
| <i>HST EOMT / ZOMT 0402..DJT</i> | | | EURO | |
| SM43473 | HST EO06 D10 W10 L120 Z02-H | ✓ | 109 € | EOMT / ZOMT 0602 |
| SM43480 | HST EO06 D12 W12 L120 Z02-H | ✓ | 131 € | |

*Suitable Insert brand is DJT.

| Size Designation | Master Insert* | Spare Parts | | |
|------------------|--------------------|------------------------|------------------|--------------------|
| | | Screw | Torx Key | Screw Torque Value |
| D10 - D12 | EOMT/ZOMT.. 0602.. | SSV M1.8x4-9501 | STK-T06-9906 | N-m 0,6 |





| Ordering Code | Item Designation | | Price | Master Insert* |
|------------------------|-----------------------------|---|-------|------------------|
| <i>HST LPGT 0102..</i> | | | EURO | |
| SM37489 | HST LP01 D10 C10 L100 Z02-H | ✓ | 109 € | LPGT 0102.. KYCR |
| SM37496 | HST LP01 D12 C12 L120 Z03-H | ✓ | 115 € | |
| SM51669 | HST LP01 D14 C12 L120 Z03-H | ✓ | 118 € | |
| SM37502 | HST LP01 D16 C16 L120 Z04-H | ✓ | 127 € | |



| Size Designation | Master Insert* | Spare Parts | | |
|------------------|----------------|----------------------|------------------|--------------------|
| | | Screw | Torx Key | Screw Torque Value |
| D10 - D16 | LPGT 0102.. | SSV M2x4-9521 | STK-T06-9906 | N-m 0,6 |

High Feed Milling Tools





| Ordering Code | Item Designation | | Price | Master Insert* |
|-------------------------------------|-------------------------------|---|-------|---|
| HST WNMX 0603.. / 09T3.. | |  | EURO |  |
| SM44333 | HST WN0603 D17 W16 L150 Z02-H | ✓ | 80 € | WNMX 0603.. |
| SM44340 | HST WN0603 D20 W20 L150 Z02-H | ✓ | 86 € | |
| SM44357 | HST WN0603 D21 W20 L150 Z02-H | ✓ | 86 € | |
| SM44364 | HST WN0603 D25 W25 L150 Z03-H | ✓ | 99 € | |
| SM44371 | HST WN0603 D26 W25 L150 Z03-H | ✓ | 99 € | |
| SM44388 | HST WN0603 D32 W32 L150 Z04-H | ✓ | 119 € | |
| SM44395 | HST WN0603 D33 W32 L150 Z04-H | ✓ | 119 € | |
| SM26261 | HST WN09T3 D25 W25 L150 Z02-H | ✓ | 86 € | WNMX 09T3.. |
| SM26278 | HST WN09T3 D25 C25 L200 Z02 | - | 103 € | |
| SM26285 | HST WN09T3 D25 C25 L300 Z02 | - | 129 € | |
| SM26292 | HST WN09T3 D26 W25 L150 Z02-H | ✓ | 86 € | |
| SM26308 | HST WN09T3 D26 C25 L200 Z02 | - | 104 € | |
| SM26315 | HST WN09T3 D26 C25 L300 Z02 | - | 129 € | |
| SM26322 | HST WN09T3 D32 W25 L150 Z03-H | ✓ | 103 € | |
| SM56480 | HST WN09T3 D32 W32 L150 Z03-H | ✓ | 106 € | |
| SM26339 | HST WN09T3 D32 C25 L200 Z03 | - | 120 € | |
| SM56497 | HST WN09T3 D32 C32 L200 Z03 | - | 120 € | |
| SM26346 | HST WN09T3 D32 C32 L300 Z03 | - | 138 € | |
| SM26353 | HST WN09T3 D33 W32 L150 Z03-H | ✓ | 103 € | |
| SM26360 | HST WN09T3 D33 C32 L200 Z03 | - | 120 € | |
| SM26377 | HST WN09T3 D33 C32 L300 Z03 | - | 138 € | |
| SM26384 | HST WN09T3 D35 W32 L150 Z04-H | ✓ | 112 € | |
| SM26391 | HST WN09T3 D35 C32 L200 Z04 | - | 129 € | |
| SM26407 | HST WN09T3 D35 C32 L300 Z04 | - | 146 € | |
| SM26414 | HST WN09T3 D40 W32 L150 Z04-H | ✓ | 112 € | |
| SM26421 | HST WN09T3 D40 W32 L200 Z04-H | ✓ | 129 € | |
| SM26438 | HST WN09T3 D40 C32 L300 Z04 | - | 155 € | |







| Ordering Code | Item Designation | | Price | Master Insert* |
|-------------------------------------|------------------------------|---|-------|---|
| MHT WNMX 0603.. / 09T3.. | |  | EURO |  |
| SM45620 | MHT WN0603 D20 M10 L30 Z02-H | ✓ | 103 € | WNMX 0603.. |
| SM45637 | MHT WN0603 D25 M12 L35 Z03-H | ✓ | 106 € | |
| SM45644 | MHT WN0603 D32 M16 L43 Z04-H | ✓ | 110 € | |
| SM36635 | MHT WN09T3 D25 M12 L35 Z02-H | ✓ | 87 € | WNMX 09T3.. |
| SM25790 | MHT WN09T3 D32 M16 L43 Z03-H | ✓ | 103 € | |
| SM27312 | MHT WN09T3 D35 M16 L43 Z04-H | ✓ | 106 € | |
| SM25806 | MHT WN09T3 D40 M16 L43 Z04-H | ✓ | 114 € | |
| SM39094 | MHT WN09T3 D42 M16 L43 Z04-H | ✓ | 118 € | |



| Ordering Code | Item Designation | | Price | Master Insert* |
|----------------------------|-----------------------------|---|-------|---|
| HTK WNMX 09T3.. | |  | EURO |  |
| SM28081 | HTK WN09T3 D40 A16 Z04-H | ✓ | 102 € | WNMX 09T3.. |
| SM28074 | HTK WN09T3 D50 A22 Z05-H | ✓ | 122 € | |
| SM56008 | HTKL WN09T3 D50 A22 Z05-H** | ✓ | 129 € | |
| SM51973 | HTK WN09T3 D52 A22 Z05-H | ✓ | 134 € | |
| SM22560 | HTK WN09T3 D63 A22 Z06-H | ✓ | 144 € | |
| SM56015 | HTKL WN09T3 D63 A22 Z06-H** | ✓ | 151 € | |
| SM51980 | HTK WN09T3 D66 A27 Z06-H | ✓ | 151 € | |

*Suitable Insert brand is KRLY **Left Side / Sol Yön

High Feed Milling Tools

| Size Designation | Master Insert* | Spare Parts | | |
|------------------|---|---|---|---|
| | | Screw | Torx Key | Screw Torque Value |
| D17 - D21 |  |  |  |  N-m |
| D25 - D33 | | | | |
| D25 - D66 | WNMX 0603.. | SSV M2.5x6-9505 SSV M2.5x7-9506 | STK-T08-9908 | 1,2 |
| | WNMX 09T3.. | SSV M3x8-9508 | | 1,9 |



| Ordering Code | Item Designation | | Price | Master Insert* |
|---|-----------------------------|---|-------|----------------|
| <i>HST JOMT 06T2.. / 0803.. JDM.-09T3..</i> | | | EURO | |
| SM35041 | HST JO06 D16 W16 L120 Z02-H | ✓ | 86 € | JOMT 06T2.. |
| SM35058 | HST JO06 D17 W16 L120 Z02-H | ✓ | 86 € | |
| SM35065 | HST JO06 D20 W20 L120 Z03-H | ✓ | 94 € | |
| SM35072 | HST JO06 D22 W20 L120 Z03-H | ✓ | 94 € | |
| SM35089 | HST JO08 D17 W16 L150 Z01-H | ✓ | 100 € | JOMT 0803.. |
| SM35096 | HST JO08 D21 W20 L150 Z02-H | ✓ | 104 € | |
| SM35102 | HST JO08 D26 W25 L150 Z03-H | ✓ | 115 € | |
| SM35003 | HST JD09 D25 W25 L150 Z02-H | ✓ | 104 € | JDM. 09T3.. |
| SM35010 | HST JD09 D26 W25 L150 Z02-H | ✓ | 104 € | |
| SM35027 | HST JD09 D32 W32 L150 Z03-H | ✓ | 115 € | |
| SM35034 | HST JD09 D33 W32 L150 Z03-H | ✓ | 115 € | |



| Ordering Code | Item Designation | | Price | Master Insert* |
|--|----------------------------|---|-------|----------------|
| <i>MHT JOMT 0803.. JDM.-09T3..</i> | | | EURO | |
| SM37175 | MHT JO08 D25 M12 L35 Z03-H | ✓ | 87 € | JOMT 0803.. |
| SM26636 | MHT JO08 D32 M16 L43 Z04-H | ✓ | 106 € | |
| SM37199 | MHT JO08 D35 M16 L43 Z04-H | ✓ | 106 € | |
| SM37083 | MHT JD09 D25 M12 L35 Z02-H | ✓ | 87 € | JDM. 09T3.. |
| SM37090 | MHT JD09 D32 M16 L43 Z03-H | ✓ | 103 € | |
| SM37106 | MHT JD09 D35 M16 L43 Z03-H | ✓ | 103 € | |



| Ordering Code | Item Designation | | Price | Master Insert* |
|---|------------------------|---|-------|----------------|
| <i>HTK JOMT 0803.. JDM.-09T3.. / 1204..</i> | | | EURO | |
| SM33184 | HTK JO08 D40 A16 Z04-H | ✓ | 99 € | JOMT 0803.. |
| SM00906 | HTK JO08 D40 A16 Z05-H | ✓ | 103 € | |
| SM33191 | HTK JO08 D50 A22 Z05-H | ✓ | 118 € | |
| SM34761 | HTK JD09 D40 A16 Z04-H | ✓ | 99 € | JDM. 09T3.. |
| SM34778 | HTK JD09 D50 A22 Z05-H | ✓ | 118 € | |
| SM34785 | HTK JD12 D50 A22 Z04-H | ✓ | 118 € | JDM. 1204.. |
| SM34792 | HTK JD12 D63 A22 Z05-H | ✓ | 139 € | |

Cooling mounting screw is optional / See Page 294 for cooling mounting screws.

İçten su vermeli montaj vidaları opsiyoneldir. / Bkz. Sayfa 294 İçten su vermeli montaj vidaları için.

*Suitable Insert brand is MTSBH.

| Size Designation | Master Insert* | Spare Parts | | |
|------------------|----------------|------------------|--------------|---------------------------|
| | | Screw | Torx Key | Screw Torque Value N-m |
| D16 - D17 | JOMT 06T2.. | SSV M2.5x6-9505 | STK-T08-9908 | 1,2 |
| D20 - D22 | | SSV M2.5x7-9506 | | |
| D17 - D21 | JOMT 0803.. | SSV M3x6-9507 | | 1,9 |
| D25 - D50 | | SSV M3x8-9508 | | |
| D25 - D32 | JDM. 09T3.. | SSV M3.5x8-9510 | STK-T15-9910 | 2,9 |
| D40 - D50 | | SSV M3.5x10-9511 | | |
| D50 - D63 | JDM. 1204.. | SSV M4x10 9514 | | 4,3 |



| Ordering Code | Item Designation | | Price | Master Insert* |
|-------------------------------------|-----------------------------|---|-------|----------------|
| HST WDMT 0603.. / 0804.. | | | EURO | |
| SM37403 | HST WD06 D16 W16 L120 Z02-H | ✓ | 86 € | WDMT 0603.. |
| SM37410 | HST WD06 D18 W16 L120 Z02-H | ✓ | 86 € | |
| SM37427 | HST WD06 D20 W20 L120 Z03-H | ✓ | 94 € | |
| SM37434 | HST WD06 D22 W20 L120 Z03-H | ✓ | 94 € | |
| SM37441 | HST WD08 D20 W20 L150 Z02-H | ✓ | 100 € | WDMT 0804.. |
| SM37458 | HST WD08 D22 W20 L150 Z02-H | ✓ | 100 € | |
| SM37465 | HST WD08 D25 W25 L150 Z03-H | ✓ | 104 € | |
| SM37472 | HST WD08 D26 W25 L150 Z03-H | ✓ | 104 € | |
| SM34914 | HST WD08 D32 W32 L150 Z04-H | ✓ | 115 € | |
| SM34907 | HST WD08 D33 W32 L150 Z04-H | ✓ | 115 € | |



| Ordering Code | Item Designation | | Price | Master Insert* |
|----------------------------|----------------------------|---|-------|----------------|
| MHT WDMT 0804.. | | | EURO | |
| SM37205 | MHT WD08 D25 M12 L35 Z03-H | ✓ | 87 € | WDMT 0804.. |
| SM37212 | MHT WD08 D32 M16 L43 Z03-H | ✓ | 103 € | |
| SM37229 | MHT WD08 D35 M16 L43 Z04-H | ✓ | 103 € | |



| Ordering Code | Item Designation | | Price | Master Insert* |
|-------------------------------------|------------------------|---|-------|----------------|
| HTK WDMT 0804.. / 1204.. | | | EURO | |
| SM33207 | HTK WD08 D40 A16 Z04-H | ✓ | 99 € | WDMT 0804.. |
| SM33214 | HTK WD08 D50 A22 Z05-H | ✓ | 118 € | WDMT 1204.. |
| SM33221 | HTK WD12 D50 A22 Z04-H | ✓ | 118 € | |
| SM33238 | HTK WD12 D63 A22 Z05-H | ✓ | 139 € | |

Cooling mounting screw is optional / See Page 294 for cooling mounting screws.
İçten su vermeli montaj vidaları opsiyoneldir. / Bkz. Sayfa 294 İçten su vermeli montaj vidaları için.

*Suitable Insert brand is SMTM.

| Size Designation | Master Insert* | Spare Parts | | |
|------------------|----------------|-------------|----------|--------------------|
| | | Screw | Torx Key | Screw Torque Value |
| D16 - D18 | WDMT 0603.. | | | 1,2 |
| D20 - D22 | | | | |
| D20 - D22 | WDMT 0804.. | | | 1,9 |
| D25 - D50 | | | | |
| D50 - D63 | WDMT 1204.. | | | 4,3 |



| Ordering Code | Item Designation | | Price | Master Insert* |
|---------------|-------------------------------|---|-------|----------------|
| | HST WDMW 06T3 | | EURO | |
| SM45002 | HST WDMW06 D25 W25 L150 Z02-H | ✓ | 115 € | WDMW 06T3.. |
| SM45019 | HST WDMW06 D32 W32 L150 Z03-H | ✓ | 129 € | |



| Ordering Code | Item Designation | | Price | Master Insert* |
|---------------|------------------------------------|---|-------|----------------|
| | HTK WDMW 06T3 / 0805 / 10X6 | | EURO | |
| SM44265 | HTK WDMW06 D40 A16 Z04-H | ✓ | 108 € | WDMW 06T3.. |
| SM44272 | HTK WDMW06 D50 A22 Z05-H | ✓ | 129 € | |
| SM44289 | HTK WDMW08 D50 A22 Z04-H | ✓ | 129 € | WDMW 0805.. |
| SM44296 | HTK WDMW08 D63 A22 Z05-H | ✓ | 151 € | |
| SM46832 | HTK WDMW10 D125 B40 Z06 | - | 318 € | WDMW 10X6.. |
| SM46849 | HTK WDMW10 D160 C40 Z07 | - | 410 € | |

Cooling mounting screw is optional / See Page 294 for cooling mounting screws.
İçten su vermeli montaj vidaları opsiyoneldir. / Bkz. Sayfa 294 İçten su vermeli montaj vidaları için. *Suitable Insert brand is DJT.

| Size Designation | Master Insert* | Spare Parts | | |
|------------------|----------------|--------------------|--------------|--------------------|
| | | Screw | Torx Key | Screw Torque Value |
| D25 - D50 | WDMW 06T3.. | SSV M3.5x8 SC-9513 | STK-T10-9909 | 2,9 |
| D50 - D63 | WDMW 0805.. | SSV M4.5x11-9518 | STK-T20-9911 | 4,3 |
| D125 - D160 | WDMW 10X6.. | SSV M5x13-9519 | | 8,5 |



| Ordering Code | Item Designation | | Price | Master Insert* |
|---------------|-----------------------------|---|-------|----------------|
| | HST WOM. 04T2 | | EURO | |
| SM44944 | HST WO04 D16 W16 L150 Z02-H | ✓ | 94 € | WOM. 04T2.. |
| SM44951 | HST WO04 D20 W20 L150 Z03-H | ✓ | 103 € | |



| Ordering Code | Item Designation | | Price | Master Insert* |
|---------------|----------------------------|---|-------|----------------|
| | MHT WOM. 04T2 | | EURO | |
| SM44968 | MHT WO04 D16 M08 L25 Z02-H | ✓ | 103 € | WOM. 04T2.. |
| SM44975 | MHT WO04 D20 M10 L30 Z03-H | ✓ | 109 € | |

*Suitable Insert brand is DJT.

| Size Designation | Master Insert* | Spare Parts | | |
|------------------|----------------|-----------------|--------------|--------------------|
| | | Screw | Torx Key | Screw Torque Value |
| D16 - D20 | WOM.04T2.. | SSV M2.5x6-9505 | STK-T08-9908 | 1,2 |



| Ordering Code | Item Designation | | Price | Master Insert* |
|---------------|------------------------|---|-------|----------------|
| | HTK WXCU 0705.. | | EURO | |
| SM46764 | HTK WX07 D40 A16 Z04-H | ✓ | 112 € | WXCU 0705.. |
| SM46771 | HTK WX07 D50 A22 Z05-H | ✓ | 134 € | |
| SM46788 | HTK WX07 D63 A22 Z06-H | ✓ | 158 € | |

Cooling mounting screw is optional / See Page 294 for cooling mounting screws.
İçten su vermeli montaj vidaları opsiyoneldir. / Bkz. Sayfa 294 İçten su vermeli montaj vidaları için.

*Suitable Insert brand is ISC.

| Size Designation | Master Insert* | Spare Parts | | |
|------------------|----------------|---------------------|------------------|--------------------|
| | | Screw | Torx Key | Screw Torque Value |
| D40 - D63 | WXCU 0705.. | SSV M4x9x5-9528 | STK-T15-9910 | N-m 4,3 |



| Ordering Code | Item Designation | | Price | Master Insert* |
|---------------|------------------------|---|-------|----------------|
| | HTK WOEJ 0905.. | | EURO | |
| SM43442 | HTK WO09 D40 A16 Z04-H | ✓ | 139 € | WOEJ 0905.. |
| SM43459 | HTK WO09 D50 A22 Z05-H | ✓ | 151 € | |
| SM43466 | HTK WO09 D63 A22 Z06-H | ✓ | 186 € | |

Cooling mounting screw is optional / See Page 294 for cooling mounting screws.
İçten su vermeli montaj vidaları opsiyoneldir. / Bkz. Sayfa 294 İçten su vermeli montaj vidaları için.

*Suitable Insert brand is KNMTL.

| Size Designation | Master Insert* | Spare Parts | | |
|------------------|----------------|-------------------|------------------|--------------------|
| | | Screw | Torx Key | Screw Torque Value |
| D40 - D63 | WOEJ 0905.. | SSV M3x8-9508 | STK-T08-9908 | N-m 1,9 |



| Ordering Code | Item Designation | | Price | Master Insert* |
|---------------|--------------------------|---|-------|----------------|
| | HTK 218.21 | | EURO | |
| SM40274 | HTK 218.21 D50 A22 Z05-H | ✓ | 162 € | 218.21 |
| SM40281 | HTK 218.21 D63 A22 Z06-H | ✓ | 179 € | |
| SM40298 | HTK 218.21 D80 A27 Z07-H | ✓ | 218 € | |

Cooling mounting screw is optional / See Page 294 for cooling mounting screws.
İçten su vermeli montaj vidaları opsiyoneldir. / Bkz. Sayfa 294 İçten su vermeli montaj vidaları için.

*Suitable Insert brand is SCO.

| Size Designation | Master Insert* | Spare Parts | | |
|------------------|----------------|----------------------|------------------|--------------------|
| | | Screw | Torx Key | Screw Torque Value |
| D50 - D80 | 218.21 | SSV M4x12x5-9529 | STK-T15-9910 | N-m 4,3 |



| Ordering Code | Item Designation | | Price | Master Insert* |
|---------------|--------------------------|---|-------|----------------|
| | HTK WNMU 0907.. | | EURO | |
| SM44302 | HTK WNMU09 D63 A22 Z05-H | ✓ | 158 € | WNMU 0907.. |
| SM44319 | HTK WNMU09 D66 A27 Z06-H | ✓ | 187 € | |

Cooling mounting screw is optional / See Page 294 for cooling mounting screws.

İçten su vermeli montaj vidaları opsiyoneldir. / Bkz. Sayfa 294 İçten su vermeli montaj vidaları için.

*Suitable Insert brand is DJT.

| Size Designation | Master Insert* | Spare Parts | | |
|------------------|----------------|----------------|--------------|--------------------|
| | | Screw | Torx Key | Screw Torque Value |
| D63 - D66 | WNMU 0907.. | SSV M5x13-9519 | STK-T20-9911 | N-m 8,5 |



| Ordering Code | Item Designation | | Price | Master Insert* |
|---------------|-------------------------------|---|-------|----------------|
| | HST SDMT 09T3.. | | EURO | |
| SM26445 | HST SDMT09 D25 W25 L150 Z02-H | ✓ | 86 € | SDMT 09T3.. |
| SM26452 | HST SDMT09 D32 W25 L150 Z03-H | ✓ | 104 € | |
| SM26469 | HST SDMT09 D35 W32 L150 Z03-H | ✓ | 112 € | |



| Ordering Code | Item Designation | | Price | Master Insert* |
|---------------|------------------------------|---|-------|----------------|
| | MHT SDMT 09T3.. | | EURO | |
| SM25813 | MHT SDMT09 D25 M12 L35 Z02-H | ✓ | 87 € | SDMT 09T3.. |
| SM25820 | MHT SDMT09 D32 M16 L43 Z03-H | ✓ | 99 € | |
| SM25837 | MHT SDMT09 D35 M16 L43 Z03-H | ✓ | 102 € | |
| SM25844 | MHT SDMT09 D40 M16 L43 Z04-H | ✓ | 106 € | |



| Ordering Code | Item Designation | | Price | Master Insert* |
|---------------|---------------------------------|---|-------|----------------|
| | HTK SDMT 09T3.. / 1204.. | | EURO | |
| SM39117 | HTK SDMT09 D40 A16 Z04-H | ✓ | 94 € | SDMT 09T3.. |
| SM39124 | HTK SDMT09 D50 A22 Z05-H | ✓ | 114 € | |
| SM39131 | HTK SDMT09 D63 A22 Z06-H | ✓ | 128 € | |
| SM39148 | HTK SDMT12 D50 A22 Z04-H | ✓ | 114 € | SDMT 1204.. |
| SM39155 | HTK SDMT12 D63 A22 Z05-H | ✓ | 131 € | |

Cooling mounting screw is optional / See Page 294 for cooling mounting screws.

İçten su vermeli montaj vidaları opsiyoneldir. / Bkz. Sayfa 294 İçten su vermeli montaj vidaları için.

*Suitable Insert brand is ZCC-CT.

| Size Designation | Master Insert* | Spare Parts | | |
|------------------|----------------|-----------------|--------------|--------------------|
| | | Screw | Torx Key | Screw Torque Value |
| D25 - D63 | SDMT 09T3.. | SSV M3.5x8-9513 | STK-T10-9909 | N-m 2,9 |
| D50 - D63 | SDMT 1204.. | SSV M4x10-9514 | STK-T15-9910 | N-m 4,3 |



| Ordering Code | Item Designation | | Price | Master Insert* |
|---------------|-------------------------------|---|-------|----------------|
| | HST SDKX 0904.. | | EURO | |
| SM26490 | HST SDKX09 D25 W25 L120 Z02-H | ✓ | 86 € | SDKX 0904.. |
| SM26506 | HST SDKX09 D25 C25 L200 Z02 | - | 97 € | |
| SM26513 | HST SDKX09 D32 W32 L150 Z03-H | ✓ | 104 € | |
| SM26520 | HST SDKX09 D32 C32 L200 Z03 | - | 112 € | |



| Ordering Code | Item Designation | | Price | Master Insert* |
|---------------|------------------------------|---|-------|----------------|
| | MHT SDKX 0904.. | | EURO | |
| SM36932 | MHT SDKX09 D25 M12 L35 Z02-H | ✓ | 87 € | SDKX 0904.. |
| SM36963 | MHT SDKX09 D32 M16 L43 Z03-H | ✓ | 99 € | |
| SM36994 | MHT SDKX09 D35 M16 L43 Z03-H | ✓ | 102 € | |
| SM37007 | MHT SDKX09 D40 M16 L43 Z04-H | ✓ | 106 € | |



| Ordering Code | Item Designation | | Price | Master Insert* |
|---------------|-------------------------------|---|-------|----------------|
| | HTK SDKX 0904../1205.. | | EURO | |
| SM28029 | HTK SDKX09 D40 A16 Z04-H | ✓ | 94 € | SDKX 0904.. |
| SM28012 | HTK SDKX09 D50 A22 Z05-H | ✓ | 114 € | |
| SM28005 | HTK SDKX09 D63 A22 Z06-H | ✓ | 128 € | |
| SM39162 | HTK SDKX12 D50 A22 Z04-H | ✓ | 114 € | |
| SM39179 | HTK SDKX12 D63 A22 Z05-H | ✓ | 131 € | SDKX 1205.. |

*Suitable Insert brand is LMN.

| Size Designation | Master Insert* | Spare Parts | | |
|------------------|----------------|------------------|--------------|--------------------|
| | | Screw | Torx Key | Screw Torque Value |
| D25 - D63 | SDKX 0904.. | SSV M3.5x8-9513 | STK-T10-9909 | 2,9 N-m |
| D50 - D63 | SDKX 1205.. | SSV M3.5x10-9511 | STK-T15-9910 | |



| Ordering Code | Item Designation | | Price | Master Insert* |
|---------------|--------------------------------|---|-------|----------------|
| | HST R210.09.. | | EURO | |
| SM37366 | HST R210.09 D25 W25 L150 Z02-H | ✓ | 104 € | R210.09.. |
| SM37373 | HST R210.09 D26 W25 L150 Z02-H | ✓ | 104 € | |
| SM37380 | HST R210.09 D32 W32 L150 Z03-H | ✓ | 115 € | |
| SM37397 | HST R210.09 D33 W32 L150 Z03-H | ✓ | 115 € | |



| Ordering Code | Item Designation | | Price | Master Insert* |
|---------------|-------------------------------|---|-------|----------------|
| | MHT R210.09.. | | EURO | |
| SM37014 | MHT R210.09 D25 M12 L35 Z02-H | ✓ | 87 € | R210.09.. |
| SM37021 | MHT R210.09 D32 M16 L43 Z03-H | ✓ | 99 € | |
| SM37038 | MHT R210.09 D35 M16 L43 Z03-H | ✓ | 102 € | |
| SM40175 | MHT R210.09 D42 M16 L43 Z4-H | ✓ | 106 € | |



| Ordering Code | Item Designation | | Price | Master Insert* |
|---------------|---------------------------|---|-------|----------------|
| | HTK R210.09.. | | EURO | |
| SM32996 | HTK R210.09 D40 A16 Z04-H | ✓ | 94 € | R210.09.. |
| SM33009 | HTK R210.09 D50 A22 Z05-H | ✓ | 114 € | |
| SM33016 | HTK R210.09 D63 A22 Z06-H | ✓ | 131 € | |

| Size Designation | Master Insert* | Spare Parts | | |
|------------------|----------------|------------------|--------------|--------------------|
| | | Screw | Torx Key | Screw Torque Value |
| D25 - D26 | R210.09.. | SSV M3.5x8-9510 | STK-T15-9910 | 2,9 N-m |
| D32 - D63 | | SSV M3.5x10-9511 | | |

*Suitable Insert brand is SDVK.

High Feed Milling Tools



| Ordering Code | Item Designation | | Price | Master Insert* |
|---------------|--|---|-------|----------------|
| | HST XPLX 0603.. XDLX 09T3.. | | EURO | |
| SM29507 | HST XP06 D16 W16 L150 Z02-H | ✓ | 86 € | XPLX 0603.. |
| SM29484 | HST XP06 D16 C16 L200 Z02 | - | 104 € | |
| SM29491 | HST XP06 D17 W16 L150 Z02-H | ✓ | 86 € | |
| SM29477 | HST XP06 D17 W16 L200 Z02 | - | 104 € | |
| SM29514 | HST XP06 D20 W20 L150 Z03-H | ✓ | 94 € | |
| SM29521 | HST XP06 D21 W20 L150 Z03-H | - | 94 € | XDLX 09T3.. |
| SM29545 | HST XD09 D25 W25 L150 Z02-H | ✓ | 104 € | |
| SM29552 | HST XD09 D25 W25 L200 Z02 | - | 115 € | |
| SM29538 | HST XD09 D26 W25 L150 Z02-H | ✓ | 104 € | |
| SM29569 | HST XD09 D26 W25 L200 Z02 | - | 115 € | |



| Ordering Code | Item Designation | | Price | Master Insert* |
|---------------|--|---|-------|----------------|
| | MHT XPLX 0603.. XDLX 09T3.. | | EURO | |
| SM36734 | MHT XP06 D16 M08 L25 Z02-H | ✓ | 87 € | XPLX 0603.. |
| SM36765 | MHT XP06 D20 M10 L30 Z03-H | ✓ | 99 € | |
| SM36772 | MHT XP06 D22 M10 L30 Z03-H | ✓ | 102 € | |
| SM29446 | MHT XD09 D25 M12 L35 Z02-H | ✓ | 85 € | XDLX 09T3.. |
| SM27893 | MHT XD09 D32 M16 L43 Z03-H | ✓ | 100 € | |
| SM29453 | MHT XD09 D35 M16 L43 Z03-H | ✓ | 100 € | |
| SM29460 | MHT XD09 D40 M16 L43 Z04-H | ✓ | 106 € | |
| SM27909 | MHT XD09 D42 M16 L43 Z04-H | ✓ | 106 € | |



| Ordering Code | Item Designation | | Price | Master Insert* |
|---------------|----------------------------------|---|-------|----------------|
| | HTK XDLX 09T3.. | | EURO | |
| SM33092 | HTK XD09 D40 A16 Z04-H | ✓ | 94 € | XDLX 09T3. |
| SM33108 | HTK XD09 D50 A22 Z05-H | ✓ | 114 € | |
| SM33115 | HTK XD09 D63 A22 Z06-H | ✓ | 131 € | |

Cooling mounting screw is optional / See Page 294 for cooling mounting screws.
İçten su vermeli montaj vidaları opsiyoneldir. / Bkz. Sayfa 294 İçten su vermeli montaj vidaları için.

*Suitable Insert brand is CRTZ.

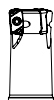

| Size Designation | Master Insert* | Spare Parts | | |
|------------------|----------------|------------------|--------------|---------------------------|
| | | Screw | Torx Key | Screw Torque Value N-m |
| D16 - D22 | XPLX 0603.. | SSV M2.5x6-9505 | STK-T08-9908 | 1,2 |
| D25 - D32 | XDLX 09T3.. | SSV M3.5x8-9510 | STK-T15-9910 | 2,9 |
| D35 - D63 | | SSV M3.5x10-9511 | | |



| Ordering Code | Item Designation | | Price | Master Insert* |
|---------------|-----------------------------|---|-------|----------------|
| | HST SWMT 0904.. | | EURO | |
| SM58934 | HST SW09 D25 W25 L150 Z03-H | ✓ | 112 € | SWMT 0904.. |
| SM58941 | HST SW09 D32 W32 L150 Z04-H | ✓ | 123 € | |



| Ordering Code | Item Designation | | Price | Master Insert* |
|---------------|----------------------------|---|-------|----------------|
| | MHT SWMT 0904.. | | EURO | |
| SM58958 | MHT SW09 D25 M12 L35 Z03-H | ✓ | 95 € | SWMT 0904.. |
| SM58965 | MHT SW09 D32 M16 L43 Z04-H | ✓ | 101 € | |



| Ordering Code | Item Designation | | Price | Master Insert* |
|---------------|-------------------------------------|---|-------|----------------|
| | HTK SWMT 0904.. / 1506.. | | EURO | |
| SM53038 | HTK SW09 D40 A16 Z04-H | ✓ | 97 € | SWMT 0904.. |
| SM53045 | HTK SW09 D50 A22 Z05-H | ✓ | 114 € | |
| SM53052 | HTK SW09 D52 A22 Z05-H | ✓ | 134 € | |
| SM53069 | HTK SW09 D63 A22 Z06-H | ✓ | 146 € | |
| SM53076 | HTK SW15 D63 A22 Z04-H | ✓ | 146 € | SWMT 1506.. |
| SM53083 | HTK SW15 D66 A27 Z04-H | ✓ | 162 € | |
| SM53090 | HTK SW15 D80 A27 Z05-H | ✓ | 202 € | |

Cooling mounting screw is optional / See Page 294 for cooling mounting screws.
İçten su vermeli montaj vidaları opsiyoneldir. / Bkz. Sayfa 294 İçten su vermeli montaj vidaları için.

*Suitable Insert brand is TNGLY.

| Size Designation | Master Insert* | Spare Parts | | |
|------------------|----------------|----------------|--------------|---------------------------|
| | | Screw | Torx Key | Screw Torque Value N-m |
| D25 - D63 | SWMT 0904.. | SSV M3x8-9508 | STK-T08-9908 | 1,9 |
| D63 - D80 | SWMT 1506.. | SSV M5x13-9519 | STK-T20-9911 | 8,5 |



| Ordering Code | Item Designation | | Price | Master Insert* |
|---------------|--|---|-------|----------------|
| | HST SPNW / SPET / SPMT 1004.. | | EURO | |
| SM44210 | HST SP10 D25 W25 L150 Z02-H | ✓ | 115 € | SP.. 1004.. |
| SM44227 | HST SP10 D32 W32 L150 Z03-H | ✓ | 129 € | |



| Ordering Code | Item Designation | | Price | Master Insert* |
|---------------|--|---|-------|----------------|
| | MHT SPNW / SPET / SPMT 1004.. | | EURO | |
| SM44982 | MHT SP10 D25 M12 L35 Z02-H | ✓ | 109 € | SP.. 1004.. |
| SM51676 | MHT SP10 D32 M16 L43 Z03-H | ✓ | 129 € | |



| Ordering Code | Item Designation | | Price | Master Insert* |
|---------------|--|---|-------|----------------|
| | HTK SP.. 1004.. / 1404.. / 2006.. | | EURO | |
| SM43909 | HTK SP10 D40 A16 Z04-H | ✓ | 129 € | SP.. 1004.. |
| SM43916 | HTK SP10 D50 A22 Z05-H | ✓ | 139 € | |
| SM43923 | HTK SP10 D63 A22 Z06-H | ✓ | 169 € | |
| SM43930 | HTK SP14 D50 A22 Z04-H | ✓ | 139 € | SP.. 1405.. |
| SM50297 | HTK SP14 D63 A22 Z05-H | ✓ | 169 € | SPEW 2006.. |
| SM43954 | HTK SP20 D50 A22 Z05-H | ✓ | 139 € | |
| SM43961 | HTK SP20 D63 A22 Z06-H | ✓ | 169 € | |

Cooling mounting screw is optional / See Page 294 for cooling mounting screws.
İçten su vermeli montaj vidaları opsiyoneldir. / Bkz. Sayfa 294 İçten su vermeli montaj vidaları için.

*Suitable Insert brand is DJT.

| Size Designation | Master Insert* | Spare Parts | | |
|------------------|----------------|------------------|--------------|---------------------------|
| | | Screw | Torx Key | Screw Torque Value N·m |
| D25 | SP.. 1004.. | SSV M3.5x8-9510 | STK-T15-9910 | 2,9 |
| D32 - D63 | | SSV M3.5x10-9511 | | |
| D50 - D63 | SP.. 1405.. | SSV M5x13-9519 | STK-T20-9911 | 8,5 |
| D50 - D63 | SPEW 2006 | SSV M6x16-9520 | | 10 |

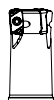



| Ordering Code | Item Designation | | Price | Master Insert* |
|----------------------------|-----------------------------|---|-------------|----------------|
| HST SOMT 1004.. | | | <i>EURO</i> | |
| SM52680 | HST SO10 D32 W32 L150 Z03-H | ✓ | 129 € | SOMT 1004.. |
| SM52604 | HST SO10 D35 W32 L150 Z03-H | ✓ | 129 € | |
| SM52635 | HST SO10 D40 W32 L150 Z04-H | ✓ | 157 € | |



| Ordering Code | Item Designation | | Price | Master Insert* |
|----------------------------|----------------------------|---|-------------|----------------|
| MHT SOMT 1004.. | | | <i>EURO</i> | |
| SM37045 | MHT SO10 D32 M16 L43 Z03-H | ✓ | 100 € | SOMT 1004.. |
| SM37052 | MHT SO10 D35 M16 L43 Z03-H | ✓ | 100 € | |
| SM37076 | MHT SO10 D40 M16 L43 Z04-H | ✓ | 106 € | |
| SM29354 | MHT SO10 D42 M16 L43 Z04-H | ✓ | 106 € | |



| Ordering Code | Item Designation | | Price | Master Insert* |
|-------------------------------------|-------------------------|---|-------------|----------------|
| HTK SOMT 1004.. / 1405.. | | | <i>EURO</i> | |
| SM33061 | HTK SO10 D40 A16 Z04-H | ✓ | 94 € | SOMT 1004.. |
| SM33078 | HTK SO10 D50 A22 Z05-H | ✓ | 114 € | |
| SM33085 | HTK SO10 D63 A22 Z06-H | ✓ | 128 € | |
| SM43411 | HTK SO14 D63 A22 Z05-H | ✓ | 128 € | SOMT 1405.. |
| SM43428 | HTK SO14 D66 A27 Z05-H | ✓ | 140 € | |
| SM43435 | HTK SO14 D80 A27 Z06-H | ✓ | 169 € | |
| SM01996 | HTK SO14 D100 A32 Z07-H | ✓ | 213 € | |
| SM02009 | HTK SO14 D125 B40 Z08 | - | 358 € | |
| SM02016 | HTK SO14 D160 C40 Z08 | - | 426 € | |

Cooling mounting screw is optional / See Page 294 for cooling mounting screws.
İçten su vermeli montaj vidaları opsiyoneldir. / Bkz. Sayfa 294 İçten su vermeli montaj vidaları için.

*Suitable Insert brand is KYCR.

| Size Designation | Master Insert* | Spare Parts | | |
|------------------|----------------|---------------------|------------------|--------------------|
| | | Screw | Torx Key | Screw Torque Value |
| D32 - D63 | | SSV M4x9x5-9528 | STK-T15-9910 | 4,3 |
| D63 - D160 | | SSV M5x13-9519 | STK-T20-9911 | 8,5 |



| Ordering Code | Item Designation | | Price | Master Insert* |
|---------------|-----------------------------|---|-------|----------------|
| | HST ZDCW 09T3.. | | EURO | |
| SM44241 | HST ZD09 D25 W25 L150 Z02-H | ✓ | 115 € | ZDCW 09T3.. |
| SM44258 | HST ZD09 D32 W32 L150 Z03-H | ✓ | 129 € | |



| Ordering Code | Item Designation | | Price | Master Insert* |
|---------------|----------------------------|---|-------|----------------|
| | MHT ZDCW 09T3.. | | EURO | |
| SM45583 | MHT ZD09 D25 M12 L35 Z02-H | ✓ | 109 € | ZDCW 09T3.. |
| SM45590 | MHT ZD09 D32 M16 L43 Z03-H | ✓ | 129 € | |
| SM45606 | MHT ZD09 D35 M16 L43 Z03-H | ✓ | 131 € | |



| Ordering Code | Item Designation | | Price | Master Insert* |
|---------------|--------------------------------------|---|-------|----------------|
| | HTK ZDCW 09T3.. / ZDEW 1204.. | | EURO | |
| SM43978 | HTK ZD09 D40 A16 Z04-H | ✓ | 115 € | ZDCW 09T3.. |
| SM44234 | HTK ZD09 D50 A22 Z05-H | ✓ | 139 € | |
| SM43992 | HTK ZD12 D50 A22 Z04-H | ✓ | 139 € | ZDCW 1204.. |
| SM44005 | HTK ZD12 D63 A22 Z05-H | ✓ | 169 € | |

Cooling mounting screw is optional. / See Page 294 for cooling mounting screws.
İçten su vermeli montaj vidaları opsiyoneldir. / Bkz. Sayfa 294 İçten su vermeli montaj vidaları için.

*Suitable Insert brand is PRMT.

| Size Designation | Master Insert* | Spare Parts | | |
|------------------|----------------|----------------|--------------|--------------------|
| | | Screw | Torx Key | Screw Torque Value |
| D25 - D50 | ZDCW 09T3.. | SSV M3x8-9508 | STK-T08-9908 | 1,9 |
| D50 - D63 | ZDEW 1204.. | SSV M4x10-9514 | STK-T15-9910 | 4,3 |



| Ordering Code | Item Designation | | Price | Master Insert* |
|---------------|-------------------------------|---|-------|----------------|
| | <i>HST SPKT 08T3..</i> | | EURO | |
| SM36031 | HST SPKT08 D20 W20 L150 Z02-H | ✓ | 100 € | SPKT 08T3.. |
| SM36048 | HST SPKT08 D25 W25 L150 Z03-H | ✓ | 104 € | |
| SM36055 | HST SPKT08 D32 W32 L150 Z04-H | ✓ | 115 € | |



| Ordering Code | Item Designation | | Price | Master Insert* |
|---------------|------------------------------|---|-------|----------------|
| | <i>MHT SPKT 08T3..</i> | | EURO | |
| SM26650 | MHT SPKT08 D25 M12 L35 Z03-H | ✓ | 88 € | SPKT 08T3.. |
| SM26643 | MHT SPKT08 D32 M16 L43 Z04-H | ✓ | 88 € | |
| SM39070 | MHT SPKT08 D35 M16 L43 Z04-H | ✓ | 100 € | |
| SM27923 | MHT SPKT08 D42 M16 L43 Z05-H | ✓ | 106 € | |



| Ordering Code | Item Designation | | Price | Master Insert* |
|---------------|--------------------------|---|-------|----------------|
| | <i>HTK SPKT 08T3..</i> | | EURO | |
| SM36062 | HTK SPKT08 D40 A16 Z04-H | ✓ | 94 € | SPKT 08T3.. |
| SM33122 | HTK SPKT08 D50 A22 Z05-H | ✓ | 114 € | |
| SM33139 | HTK SPKT08 D63 A22 Z06-H | ✓ | 131 € | |

Cooling mounting screw is optional / See Page 294 for cooling mounting screws.
İçten su vermeli montaj vidaları opsiyoneldir. / Bkz. Sayfa 294 İçten su vermeli montaj vidaları için.

*Suitable Insert brand is PLBT.

| Size Designation | Master Insert* | Spare Parts | | |
|------------------|----------------|---------------|--------------|---------------------------|
| | | Screw | Torx Key | Screw Torque Value N-m |
| D20 - D63 | SPKT 08T3.. | SSV M3x8-9508 | STK-T08-9908 | 1,9 |



| Ordering Code | Item Designation | | Price | Master Insert* |
|---------------|--------------------------|---|-------|----------------|
| | <i>HTK SOMT 1205..</i> | | EURO | |
| SM46795 | HTK SOMT12 D50 A22 Z04-H | ✓ | 139 € | SOMT 1205.. |
| SM46801 | HTK SOMT12 D63 A22 Z05-H | ✓ | 169 € | |

Cooling mounting screw is optional / See Page 294 for cooling mounting screws.
İçten su vermeli montaj vidaları opsiyoneldir. / Bkz. Sayfa 294 İçten su vermeli montaj vidaları için.

*Suitable Insert brand is ISC.

| Size Designation | Master Insert* | Spare Parts | | |
|------------------|----------------|----------------|--------------|---------------------------|
| | | Screw | Torx Key | Screw Torque Value N-m |
| D50 - D63 | SOMT 1205.. | SSV M4x12-9515 | STK-T15-9910 | 4,3 |



| Ordering Code | Item Designation | | Price | Master Insert* |
|--|-------------------------------|---|-------------|----------------|
| HST XPLT 0603.. / XDLT 0904.. | | | <i>EURO</i> | |
| SM46412 | HST XPLT06 D16 W16 L150 Z02-H | ✓ | 94 € | XPLT 0603.. |
| SM46429 | HST XPLT06 D20 W20 L150 Z03-H | ✓ | 103 € | |
| SM46436 | HST XPLT06 D25 W25 L150 Z04-H | ✓ | 115 € | |
| SM46443 | HST XPLT06 D32 W32 L150 Z05-H | ✓ | 130 € | |
| SM45354 | HST XDLT09 D25 W25 L150 Z02-H | ✓ | 115 € | XDLT 0904.. |
| SM45361 | HST XDLT09 D32 W32 L150 Z03-H | ✓ | 130 € | |
| SM45378 | HST XDLT09 D40 W32 L150 Z04-H | ✓ | 153 € | |



| Ordering Code | Item Designation | | Price | Master Insert* |
|------------------------|--------------------------|---|-------------|----------------|
| HTK XDLT 0904.. | | | <i>EURO</i> | |
| SM44012 | HTK XDLT09 D40 A16 Z04-H | ✓ | 129 € | XDLT 0904.. |
| SM44029 | HTK XDLT09 D50 A22 Z05-H | ✓ | 139 € | |
| SM44036 | HTK XDLT09 D63 A22 Z06-H | ✓ | 169 € | |

Cooling mounting screw is optional / See Page 294 for cooling mounting screws.
İçten su vermeli montaj vidaları opsiyoneldir. / Bkz. Sayfa 294 İçten su vermeli montaj vidaları için.

*Suitable Insert brand is KNMTL.

| Size Designation | Master Insert* | Spare Parts | | |
|------------------|----------------|--------------------|--------------|--------------------|
| | | Screw | Torx Key | Screw Torque Value |
| | | | | N-m |
| D16 | XPLT 0603.. | SSV M2.5x6-9505 | STK-T08-9908 | 1,2 |
| D20 - D32 | | SSV M2.5x7-9506 | | |
| D25 - D63 | XDLT 0904.. | SSV M3.5x8 SC-9513 | STK-T10-9909 | 2,9 |

High Feed Milling Tools



| Ordering Code | Item Designation | | Price | Master Insert* |
|------------------------|------------------------|---|-------------|----------------|
| HTK SQMU 1206.. | | | <i>EURO</i> | |
| SM46818 | HTK SQ12 D50 A22 Z04-H | ✓ | 139 € | SQMU 1206.. |
| SM46825 | HTK SQ12 D63 A22 Z05-H | ✓ | 169 € | |

Cooling mounting screw is optional / See Page 294 for cooling mounting screws.
İçten su vermeli montaj vidaları opsiyoneldir. / Bkz. Sayfa 294 İçten su vermeli montaj vidaları için.

*Suitable Insert brand is TNGLY.

| Size Designation | Master Insert* | Spare Parts | | |
|------------------|----------------|----------------|--------------|--------------------|
| | | Screw | Torx Key | Screw Torque Value |
| | | | | N-m |
| D50 - D63 | SQMU 1206.. | SSV M4x12-9515 | STK-T15-9910 | 4,3 |



| Ordering Code | Item Designation | | Price |
|--------------------------------------|-------------------------|---|-------------|
| SMVT MODULAR MILL HOLDERS | | | EURO |
| SM37236 | SMVT D15 C16 M08 L120-H | ✓ | 78 € |
| SM24151 | SMVT D18 C20 M10 L120-H | ✓ | 86 € |
| SM24144 | SMVT D18 C20 M10 L170-H | ✓ | 106 € |
| SM24168 | SMVT D24 C25 M12 L160-H | ✓ | 114 € |
| SM24175 | SMVT D24 C25 M12 L200-H | ✓ | 143 € |
| SM24182 | SMVT D24 C25 M12 L250-H | ✓ | 179 € |
| SM24199 | SMVT D31 C32 M16 L160-H | ✓ | 121 € |
| SM24205 | SMVT D31 C32 M16 L200-H | ✓ | 165 € |
| SM24212 | SMVT D31 C32 M16 L250-H | ✓ | 197 € |







| Ordering Code | Item Designation | | Price |
|--|-------------------------|---|-------------|
| CMVT CARBIDE MODULAR MILL HOLDERS | | | EURO |
| SM60418 | CMVT D16 C16 M08 L100-H | ✓ | 580 € |
| SM60425 | CMVT D16 C16 M08 L150-H | ✓ | 670 € |
| SM60432 | CMVT D16 C16 M08 L200-H | ✓ | 890 € |
| SM60449 | CMVT D20 C20 M10 L100-H | ✓ | 760 € |
| SM60456 | CMVT D20 C20 M10 L150-H | ✓ | 1040 € |
| SM60463 | CMVT D20 C20 M10 L200-H | ✓ | 1360 € |
| SM60470 | CMVT D25 C25 M12 L150-H | ✓ | 1420 € |
| SM60487 | CMVT D25 C25 M12 L200-H | ✓ | 1760 € |
| SM60494 | CMVT D32 C32 M16 L200-H | ✓ | 2660 € |



| Ordering Code | Item Designation | Price | Master Insert* | |
|---|-------------------------------------|-------------|---|-------------|
| TF90 CC..0602.. / 09T3.. / 1204.. T SLOT MILLS | | <i>EURO</i> |  | |
| SM14954 | TF90 CC06 D17x8 W16 L100 Z02 T3.5 | 81 € | CC.. 0602.. | |
| SM15128 | TF90 CC06 D20x9 W16 L120 Z02 T4 | 81 € | | |
| SM58453 | TF90 CC06 D21x8 W20 L120 Z04 T3.5 | 81 € | | |
| SM01866 | TF90 CC06 D22x8 W20 L120 Z04 T4 | 81 € | | |
| SM01873 | TF90 CC06 D22x10 W20 L120 Z04 T4 | 81 € | | |
| SM14961 | TF90 CC06 D23x10 W20 L120 Z04 T3.5 | 86 € | | |
| SM14978 | TF90 CC06 D25x10 W20 L120 Z04 T4.5 | 86 € | | |
| SM22416 | TF90 CC06 D26x11 W20 L120 Z04 T5 | 86 € | | |
| SM14985 | TF90 CC06 D30x12 W25 L120 Z04 T6 | 112 € | | |
| SM14992 | TF90 CC06 D32x12 W25 L120 Z04 T6 | 112 € | | |
| SM15005 | TF90 CC06 D35x12 W25 L120 Z04 T7.5 | 115 € | | |
| SM15012 | TF90 CC06 D40x12 W25 L120 Z06 T9 | 120 € | | |
| SM14947 | TF90 CC06 D42x12 W25 L120 Z06 T10 | 124 € | | |
| SM15043 | TF90 CC06 D45x08 W32 L120 Z06 T10 | 136 € | | |
| SM15050 | TF90 CC06 D45x10 W32 L120 Z06 T10 | 136 € | | |
| SM15067 | TF90 CC06 D50x08 W32 L120 Z06 T12.5 | 152 € | | |
| SM15074 | TF90 CC06 D50x10 W32 L120 Z06 T12.5 | 152 € | | |
| SM15081 | TF90 CC06 D55x08 W32 L120 Z08 T15 | 174 € | | |
| SM15098 | TF90 CC06 D55x10 W32 L120 Z08 T15 | 174 € | | |
| SM15104 | TF90 CC06 D60x08 W32 L120 Z08 T17.5 | 198 € | | |
| SM15111 | TF90 CC06 D60x10 W32 L120 Z08 T17.5 | 198 € | | |
| SM24090 | TF90 CC09 D35x14 W25 L120 Z04 T5 | 115 € | | CC.. 09T3.. |
| SM15029 | TF90 CC09 D42x14 W25 L120 Z04 T11 | 124 € | | |
| SM15036 | TF90 CC09 D45x14 W32 L120 Z04 T10 | 136 € | | |
| SM15135 | TF90 CC12 D47x20 W32 L120 Z04 T11 | 144 € | CC.. 1204.. | |

*Suitable Insert brand is ISO.

| Size Designation | Master Insert* | Spare Parts | | |
|------------------|---|--|---|---|
| |  | Screw  | Torx Key  | Screw Torque Value  N-m |
| D17 - D20 | CC.. 0602.. | SSV M2.5x6-9505 | STK-T08-9908 | 1,2 |
| D23 - D60 | | SSV M2.5x7-9506 | | |
| D25 - D63 | CC.. 09T3.. | SSV M3.5x10-9511 | STK-T15-9910 | 2,9 |
| D47 | CC.. 1204.. | SSV M5x13-9519 | STK-T20-9911 | 4,3 |



| Ordering Code | Item Designation | Price | Master Insert* |
|--|-------------------------------------|-------------|---|
| TF90 SPMG 0904.. / 1104.. | | <i>EURO</i> |  |
| SM15210 | TF90 SP09 D37x16 W32 L120 Z04 T7.5 | 114 € | SPMG 0904.. |
| SM15227 | TF90 SP09 D42x17 W32 L120 Z04 T10.5 | 122 € | |
| SM15203 | TF90 SP11 D47x20 W32 L120 Z04 T11.5 | 147 € | SPMG 1104.. |

*Suitable Insert brand is TGTC.





| Size Designation | Master Insert* | Spare Parts | | |
|------------------|---|--|---|---|
| |  | Screw  | Torx Key  | Screw Torque Value  N-m |
| D37 - D42 | SPMG 0904.. | SSV M3.5x10-9511 | STK-T15-9910 | 2,9 |
| D47 | SPMG 1104.. | SSV M4x10-9514 | | 4,3 |

Slot Mills





| Ordering Code | Item Designation | Price | Master Insert* |
|---|---------------------------------|-------------|---|
| TF <i>RD..0702 / 1003.. / 12T3.. / 1604..</i> | | <i>EURO</i> |  |
| SM15159 | TF RD0702 D17 W16 L120 Z02 T3.5 | 82 € | RD.. 0702.. |
| SM15166 | TF RD0702 D25 W16 L120 Z03 T5 | 85 € | |
| SM15142 | TF RD0702 D35 W25 L120 Z05 T7.5 | 114 € | |
| SM15173 | TF RD1003 D21 W25 L120 Z02 T4.5 | 84 € | RD.. 1003.. |
| SM15180 | TF RD12T3 D26 W25 L120 Z02 T5.5 | 85 € | RD.. 12T3.. |
| SM15197 | TF RD1604 D34 W32 L120 Z02 T7 | 114 € | RD.. 1604.. |





*Suitable Insert brand is ISO.

| Size Designation | Master Insert* | Spare Parts | | |
|------------------|---|---|---|---|
| |  | Screw | Torx Key | Screw Torque Value |
| D17 | RD.. 0702.. |  |  |  N-m |
| D25 - D35 | | SSV M2.5x6-9505 | STK-T08-9908 | 1,2 |
| D21 | RD.. 1003.. | SSV M2.5x7-9506 | | |
| D26 | RD.. 12T3.. | SSV-M3.5x8-SC-9513 | STK-T10-9909 | |
| D34 | RD.. 1604.. | SSV M3.5x10-9511 | | STK-T15-9910 |
| | | SSV M4x10-9514 | 4,3 | |



| Ordering Code | Item Designation | Price | Master Insert* |
|---|---------------------------|---|---|
| TSF <i>RD.. 1003.. / 12T3..</i> | |  <i>EURO</i> |  |
| SM58408 | TSF RD1003 D55 A16 Z05-H | ✓ 153 € | RD.. 1003.. |
| SM58415 | TSF RD1003 D65 A22 Z06-H | ✓ 185 € | |
| SM58422 | TSF RD1003 D80 A22 Z07-H | ✓ 213 € | |
| SM58439 | TSF RD1003 D100 A27 Z08-H | ✓ 252 € | |
| SM54318 | TSF RD12T3 D55 A16 Z05-H | ✓ 153 € | RD.. 12T3.. |
| SM54325 | TSF RD12T3 D65 A22 Z06-H | ✓ 185 € | |
| SM54332 | TSF RD12T3 D80 A22 Z07-H | ✓ 213 € | |
| SM54349 | TSF RD12T3 D100 A27 Z08-H | ✓ 252 € | |



*Suitable Insert brand is ISO.

| Size Designation | Master Insert* | Spare Parts | | |
|------------------|---|---|---|---|
| |  | Screw | Torx Key | Screw Torque Value |
| D55 - D100 | RD.. 1003.. |  |  |  N-m |
| D55 - D100 | RD.. 12T3.. | SSV-M3.5x8-SC-9513 | STK-T10-9909 | 2,9 |
| | | SSV M3.5x12-9526 | STK-T15-9910 | |



| Ordering Code | Item Designation | Price | Master Insert* |
|---|--------------------------------|-------------|---|
| <i>DKT MGM. 3C / 4C / 5C T SLOT MILLS</i> | | <i>EURO</i> |  |
| SM20672 | DKT K3C D50 W20 L120 Z02 T12 | 208 € | MGM. 3C |
| SM20702 | DKT K3C D63 W25 L120 Z02 T17 | 236 € | |
| SM20733 | DKT K3C D80 W32 L120 Z02 T20.5 | 264 € | |
| SM20689 | DKT K4C D50 W20 L120 Z02 T12 | 208 € | MGM. 4C |
| SM20719 | DKT K4C D63 W25 L120 Z02 T17 | 236 € | |
| SM20740 | DKT K4C D80 W32 L120 Z02 T20.5 | 264 € | |
| SM20696 | DKT K5C D50 W20 L120 Z02 T12 | 208 € | MGM. 5C |
| SM20726 | DKT K5C D63 W25 L120 Z02 T17 | 236 € | |
| SM20757 | DKT K5C D80 W32 L120 Z02 T20.5 | 264 € | |

*Suitable Insert brand is KRLY.



| Size Designation | Master Insert* | Spare Parts | |
|------------------|-------------------|---|---|
| | | Clap Screw | Allen Key |
| D50 | MGM. (3C - 5C) |  |  |
| D63 - D80 | | BKTV-M6x25-9215 | SAK-AA5-9904 |
| | | BKTV-M8x28-9216 | SAK-AA6-9905 |

DOVE MILLS



| Ordering Code | Item Designation | Price | Master Insert* |
|---|------------------------------|-------------|---|
| <i>BKRF 55 / 60 DCM. 11T304. DOVE MILLS</i> | | <i>EURO</i> |  |
| SM15845 | BKRF60 DC11 D32 W20 L120 Z02 | 149 € | DCM. 11T304 |
| SM15852 | BKRF60 DC11 D40 W25 L120 Z02 | 171 € | |
| SM15869 | BKRF60 DC11 D50 W25 L120 Z04 | 195 € | |
| SM15838 | BKRF55 DC11 D60 W25 L120 Z04 | 230 € | |
| SM15876 | BKRF60 DC11 D80 W32 L120 Z04 | 258 € | |











*Suitable Insert brand is ISO.

| Size Designation | Master Insert* | Spare Parts | | |
|------------------|----------------|---|---|---|
| | | Screw | Torx Key | Screw Torque Value |
| D32 - D80 | DCM. 11T304 |  |  |  N-m |
| | | SSV M3.5x10-9511 | STK-T15-9910 | 2,9 |



| Ordering Code | Item Designation | Price | Master Insert** |
|---|---------------------------------|-------------|---|
| BSDF CC..0602.. / 09T3.. / 1204.. DISC MILLING | | <i>EURO</i> |  |
| SM15395 | BSDF CC06 D60x8 d22 Z08 T14 | 143 € | CC.. 0602.. |
| SM15234 | BSDF CC06 D60x10 d22 Z08 T14 | 139 € | |
| SM15241 | BSDF CC06 D80x8 d27 Z10 T19 | 185 € | |
| SM15258 | BSDF CC06 D80x10 d27 Z10 T19 | 185 € | |
| SM15289 | BSDF CC06 D100x8 d32 Z12 T22.5 | 208 € | |
| SM15296 | BSDF CC06 D100x10 d32 Z12 T22.5 | 200 € | |
| SM15326 | BSDF CC06 D125x8 d40 Z14 T29 | 271 € | |
| SM15333 | BSDF CC06 D125x10 d40 Z14 T29 | 271 € | |
| SM15388 | BSDF CC06 D160x10 d40 Z16 T47.5 | 304 € | |
| SM50136 | BSDF CC06 D200x10 d40 Z18 T70 | 398 € | |
| SM15265 | BSDF CC09 D80x12 d27 Z08 T17.5 | 185 € | |
| SM15272 | BSDF CC09 D80x14 d27 Z08 T17.5 | 185 € | |
| SM15302 | BSDF CC09 D100x12 d32 Z10 T22.5 | 200 € | |
| SM15319 | BSDF CC09 D100x14 d32 Z10 T22.5 | 200 € | |
| SM15340 | BSDF CC09 D125x12 d40 Z12 T29 | 271 € | |
| SM15357 | BSDF CC09 D125x14 d40 Z12 T29 | 271 € | |
| SM15371 | BSDF CC09 D160x12 d40 Z14 T45 | 304 € | |
| SM15364 | BSDF CC09 D160x14 d40 Z14 T45 | 304 € | |
| SM50143 | BSDF CC09 D200x12 d40 Z16 T70 | 366 € | CC.. 1204.. |
| SM50150 | BSDF CC09 D200x14 d40 Z16 T70 | 388 € | |
| SM50167 | BSDF CC12 D200x16 d40 Z12 T70 | 366 € | |
| SM50174 | BSDF CC12 D200x18 d40 Z12 T70 | 366 € | |

*Suitable Insert brand is ISO.

| Size Designation | Master Insert* | Spare Parts | | |
|------------------|---|--|--|---|
| |  | Screw | Torx Key | Screw Torque Value |
| D60 - D200 | CC.. 0602.. |  SSV M2.5x7-9506 |  STK-T08-9908 |  1,2 |
| D80 - D200 | CC.. 09T3.. |  SSV M3.5x10-9511 |  STK-T15-9910 |  2,9 |
| D200 | CC.. 1204.. |  SSV M5x13-9519 |  STK-T20-9911 |  4,3 |



| Ordering Code | Item Designation | | Price | Master Insert* |
|---------------|---|---|-------|----------------|
| | <i>HF 10/15/17.5/20/22.5/25/30/45 TCM. 1102.. / 16T3.. CHAMFERING TOOLS</i> | | EURO | |
| SM15401 | HF10 TC16 D18-21 W16 L100 Z01 | - | 45 € | TCM. 16T3.. |
| SM15418 | HF15 TC16 D17-22 W16 L100 Z01 | - | 45 € | |
| SM15425 | HF17.5 TC16 D17-24 W16 L100 Z01 | - | 45 € | |
| SM15449 | HF20 TC16 D12-20 W16 L100 Z01 | - | 45 € | |
| SM15432 | HF20 TC16 D17-26 W16 L100 Z01 | - | 45 € | |
| SM15456 | HF22.5 TC16 D17-28 W20 L100 Z01 | - | 45 € | |
| SM15463 | HF25 TC16 D17-30 W16 L100 Z01 | - | 45 € | |
| SM15470 | HF30 TC16 D6-20 W16 L100 Z01 | - | 45 € | |
| SM15487 | HF30 TC16 D20-35 W16 L100 Z02 | - | 57 € | |
| SM15494 | HF30 TC16 D30-45 W32 L100 Z03 | - | 57 € | |
| SM50099 | HF45 TC11 D4-15 W16 L100 Z01-H | ✓ | 57 € | TCM. 1102.. |
| SM15500 | HF45 TC11 D4-15 W16 L100 Z01 | - | 49 € | |
| SM52147 | HF45 TC16 D5-26 W16 L100 Z01 | - | 49 € | TCM. 16T3.. |
| SM50105 | HF45 TC16 D10-31 W20 L100 Z02-H | ✓ | 58 € | |
| SM15517 | HF45 TC16 D10-31 W20 L100 Z02 | - | 52 € | |
| SM50112 | HF45 TC16 D14-35 W20 L100 Z02-H | ✓ | 58 € | |
| SM15524 | HF45 TC16 D14-35 W20 L100 Z02 | - | 52 € | |
| SM50129 | HF45 TC16 D22-43 W25 L100 Z03-H | ✓ | 64 € | |
| SM15531 | HF45 TC16 D22-43 W25 L100 Z03 | - | 56 € | |
| SM15548 | HF45 TC16 D32-53 W32 L100 Z04 | - | 83 € | |
| SM51683 | HF55 TC16 D16-40 W20 L100 Z03 | - | 59 € | |
| SM51690 | HF62 TC16 D14-40 W20 L100 Z03 | - | 59 € | |
| SM51706 | HF72 TC16 D14-42 W20 L100 Z03 | - | 59 € | |

*Suitable Insert brand is ISO.







| Size Designation | Master Insert* | Spare Parts | | |
|------------------|----------------|------------------|--------------|---------------------------|
| | | Screw | Torx Key | Screw Torque Value N-m |
| D4-15 | TCM. 1102.. | SSV M2.5x7-9506 | STK-T08-9908 | 1,2 |
| D6-20 - ~ | TCM. 16T3. | SSV M3.5x10-9511 | STK-T15-9910 | 2,9 |

ADJUSTABLE BORING BARS



| Ordering Code | Item Designation | Price | Master Insert** |
|--|--------------------------------|-------------|---|
| <i>SBT-CC..0602.. / 09T3.. / 1204.. ADJUSTABLE BORING BARS</i> | | <i>EURO</i> |  |
| SM15906 | SBT-CC06 D20-24 I50 W16 L100 | 198 € | CC.. 0602.. |
| SM15937 | SBT-CC06 D20-24 I100 W16 L150 | 209 € | |
| SM16019 | SBT-CC06 D20-24 I150 W16 L200 | 255 € | |
| SM15913 | SBT-CC06 D24-29 I50 W20 L100 | 206 € | |
| SM23598 | SBT-CC06 D24-29 I100 W20 L150 | 209 € | |
| SM16026 | SBT-CC06 D24-29 I180 W20 L230 | 255 € | |
| SM15920 | SBT-CC09 D29-39 I55 W20 L105 | 206 € | CC.. 09T3.. |
| SM15968 | SBT-CC09 D29-39 I105 W20 L155 | 225 € | |
| SM15890 | SBT-CC09 D29-39 I175 W20 L230 | 270 € | |
| SM15944 | SBT-CC09 D39-49 I65 W25 L120 | 206 € | |
| SM15975 | SBT-CC09 D39-49 I115 W25 L170 | 227 € | |
| SM16057 | SBT-CC09 D39-49 I200 W25 L250 | 277 € | |
| SM15951 | SBT-CC09 D49-60 I66 W32 L126 | 213 € | |
| SM15883 | SBT-CC09 D49-60 I116 W32 L176 | 241 € | |
| SM16071 | SBT-CC09 D49-60 I200 W32 L260 | 284 € | CC.. 1204.. |
| SM15982 | SBT-CC12 D59-79 I85 W32 L145 | 234 € | |
| SM16002 | SBT-CC12 D59-79 I135 W32 L195 | 241 € | |
| SM16088 | SBT-CC12 D59-79 I220 W32 L280 | 301 € | |
| SM15999 | SBT-CC12 D69-89 I85 W32 L145 | 241 € | |
| SM16033 | SBT-CC12 D69-89 I135 W32 L195 | 262 € | |
| SM39582 | SBT-CC12 D69-89 I220 W32 L290 | 319 € | |
| SM16095 | SBT-CC12 D69-89 I220 W40 L290 | 319 € | |
| SM16040 | SBT-CC12 D89-130 I105 W32 L175 | 262 € | CC.. 1204.. |
| SM16064 | SBT-CC12 D89-130 I165 W32 L225 | 277 € | |

*Suitable Insert brand is ISO.

| Size Designation | Master Insert* | Spare Parts | | | | | | |
|------------------|---|---|---|--|--------------------|---|---|--------------------|
| |  | Cartridge | Insert Screw | Insert Torx Key | Screw Torque Value | Cartridge Screw | Adjustment Screw | |
| D20-24 | CC.. 0602.. |  |  |  | 1,2 |  |  | |
| D24-29 | | KR2024 | SSV M2.5x6-9505 | STK-T08-9908 | | BKTV M4x15x6-9220 | SNSV M3x6-9301 | |
| D29-39 | CC.. 09T3.. | KR2429 | SSV M3.5x8-9510 | STK-T15-9910 | 2,9 | BKTV M5x18x8-9212 | SNSV M4x8-9302 | |
| D39-49 | | KR2939 | SSV M3.5x10-9511 | | | BKTV M6x20x8-9213 | SNSV M4x10-9303 | |
| D49-60 | | KR3949 | SSV M3.5x10-9511 | | | STK-T15-9910 | BKTV M8x30x11 9217 | SNSV M4x12-9304 |
| D59-79 | | KR4960 | | | | | | SNSV M4x16-9305 |
| D69-89 | CC.. 1204.. | KR5979 | SSV M5x13-9519 | STK-T20-9911 | 8,5 | SNSV M5x15-9307 | | |
| D89-130 | | KR6989 | | | | SNSV M5x20-9318 | | |

| Insert | | WCM.030208 ISO | WCM.040208 ISO | WCM.050308 ISO | WCM.06T308 ISO | WCM.080412 ISO |
|-----------------------------|---|---|---|---|---|---|
| | |  |  |  |  |  |
| Dimeter Range (mm) | | Ø16-19.5 | Ø20-23.5 | Ø24-29.5 | Ø30-44 | Ø45-60 |
| Size & Diameter Designation |  | ✓ Dia Range (mm) Ø16 -19.5 (With 0.50mm) | ✓ Dia Range (mm) Ø20 - 23.5 (With 0.50mm) | ✓ Dia Range (mm) Ø24 - 29.5 (With 0.50mm) | ✓ Dia Range (mm) Ø30 - 44 | ✓ Dia Range (mm) Ø45 - 60 |
| | | Page: J262 | Page: J262 | Page: J262 | Page: J263 | Page: J263 |
| |  | ✓ Dia Range (mm) Ø16 -19.5 (With 0.50mm) | ✓ Dia Range (mm) Ø20 - 23.5 (With 0.50mm) | ✓ Dia Range (mm) Ø24 - 29.5 (With 0.50mm) | ✓ Dia Range (mm) Ø30 - 44 | ✓ Dia Range (mm) Ø45 - 60 |
| | | Page: J264 | Page: J264 | Page: J264 | Page: J265 | Page: J265 |
| |  | ✓ Dia Range (mm) Ø16 -19.5 (With 0.50mm) | ✓ Dia Range (mm) Ø20 - 23.5 (With 0.50mm) | ✓ Dia Range (mm) Ø24 - 29.5 (With 0.50mm) | ✓ Dia Range (mm) Ø30 - 44 | ✓ Dia Range (mm) Ø45 - 50 |
| | | Page: J266 | Page: J266 | Page: J266 | Page: J267 | Page: J267 |
| |  | ✓ Dia Range (mm) Ø16 -19 | ✓ Dia Range (mm) Ø20 - 23 | ✓ Dia Range (mm) Ø24 - 29 | ✓ Dia Range (mm) Ø30 - 40 | - |
| | | Page: J268 | Page: J268 | Page: J268 | Page: J268 | |
| |  | - | - | - | - | - |
| | | | | | | |

| Insert | | SPMG 050204 | SPMG 060204 | SPMG 07T308 | SPMG 090408 | SPMG 110408 | SPMG 140512 |
|-----------------------------|---|---|---|---|--|---|---|
| | | TGTC | TGTC | TGTC | TGTC | TGTC | TGTC |
| | |  |  |  |  |  |  |
| Dimeter Range (mm) | | Ø12-15 | Ø15.5-21.5 | Ø22-27.5 | Ø28-33 | Ø34-41 | Ø42-54 |
| Size & Diameter Designation |  | ✓ Dia Range (mm) Ø12 - 15 (With 0.50mm) | ✓ Dia Range (mm) Ø15.5 - 21.5 (With 0.50mm) | ✓ Dia Range (mm) Ø22 - 27.5 (With 0.50mm) | ✓ Dia Range (mm) Ø28 - 33 (With 0.50mm Up to 29.5) | ✓ Dia Range (mm) Ø34 - 41 | ✓ Dia Range (mm) Ø42 - 50 |
| | | Page: J269 | Page: J269 | Page: J269 | Page: J270 | Page: J270 | Page: J270 |
| |  | ✓ Dia Range (mm) Ø12 - 15 (With 0.50mm) | ✓ Dia Range (mm) Ø15.5 - 21.5 (With 0.50mm) | ✓ Dia Range (mm) Ø22 - 27.5 (With 0.50mm) | ✓ Dia Range (mm) Ø28 - 33 (With 0.50mm Up to 29.5) | ✓ Dia Range (mm) Ø34 - 41 | ✓ Dia Range (mm) Ø42 - 54 |
| | | Page: J271 | Page: J271 | Page: J271 | Page: J272 | Page: J272 | Page: J272 |
| |  | ✓ Dia Range (mm) Ø12 - 15 (With 0.50mm) | ✓ Dia Range (mm) Ø15.5 - 21.5 (With 0.50mm) | ✓ Dia Range (mm) Ø22 - 27.5 (With 0.50mm) | ✓ Dia Range (mm) Ø28 - 33 (With 0.50mm Up to 29.5) | ✓ Dia Range (mm) Ø34 - 41 | ✓ Dia Range (mm) Ø42 - 44 |
| | | Page: J273 | Page: J273 | Page: J273 | Page: J274 | Page: J274 | Page: J274 |
| |  | ✓ Dia Range (mm) Ø13 - 15 | ✓ Dia Range (mm) Ø15 - 21 | ✓ Dia Range (mm) Ø22 - 27 | ✓ Dia Range (mm) Ø28 - 29 | - | - |
| | | Page: J275 | Page: J275 | Page: J275 | Page: J275 | | |
| |  | - | - | - | - | - | - |
| | | | | | | | |

| Insert | | SOMT 050204 TGTC | SOMT 060204 TGTC | SOMT 070306 TGTC | SOMT 08T306 TGTC | SOMT 09T308 TGTC |
|-----------------------------|---|---|---|---|---|---|
| | |  |  |  |  |  |
| Dimeter Range (mm) | | Ø14-16 | Ø16.5-19 | Ø19-22 | Ø22.5-26 | Ø26.5-30 |
| Size & Diameter Designation |  | - | - | - | - | - |
| |  | ✓ Dia Range (mm) Ø14 - 16 (With 0.50mm) | ✓ Dia Range (mm) Ø16.5 - 19 (With 0.50mm) | ✓ Dia Range (mm) Ø19 - 22 (With 0.50mm) | ✓ Dia Range (mm) Ø22.5 - 26 (With 0.50mm) | ✓ Dia Range (mm) Ø26.5 - 30 (With 0.50mm) |
| | | Page: J276 | Page: J276 | Page: J276 | Page: J276 | Page: J276 |
| |  | ✓ Dia Range (mm) Ø14 - 16 | ✓ Dia Range (mm) Ø17 - 19 | ✓ Dia Range (mm) Ø20 - 22 | ✓ Dia Range (mm) Ø23 - 26 | ✓ Dia Range (mm) Ø27 - 30 |
| | | Page: J277 | Page: J277 | Page: J277 | Page: J277 | Page: J277 |
| |  | ✓ Dia Range (mm) Ø14 - 16 | ✓ Dia Range (mm) Ø17 - 19 | ✓ Dia Range (mm) Ø20 - 22 | ✓ Dia Range (mm) Ø23 - 26 | ✓ Dia Range (mm) Ø27 - 30 |
| | | Page: J277 | Page: J277 | Page: J277 | Page: J277 | Page: J277 |
| |  | - | - | - | - | - |
| | | | | | | |

| Insert | | SPMT(PD) 040204 XOMT(PD) 040204 KRLY | SPMT(PD) 050204 XOMT(PD) 050204 KRLY | SPMT(PD) 060205 XOMT(PD) 060204 KRLY | SPMT(PD) 07T208 XOMT(PD) 07T208 KRLY | SPMT(PD) 090308 XOMT(PD) 090305 KRLY | SPMT(PD) 11T308 XOMT(PD) 11T306 KRLY | SPMT(PD) 130410 XOMT(PD) 130416 KRLY |
|---|--|---|---|---|---|---|---|---|
| | |  |  |  |  |  |  |  |
| Dimeter Range (mm) | | Ø12.5-13.5 | Ø14-16 | Ø16.5-19.5 | Ø20-23.5 | Ø24-29.5 | Ø30-35 | Ø36-42 |
| Size & Diameter Designation |  | - | ✓ Dia Range (mm) Ø14 - 16 (With 0.50mm) | ✓ Dia Range (mm) Ø17 - 19 (With 0.50mm) | ✓ Dia Range (mm) Ø20 - 23 (With 0.50mm) | ✓ Dia Range (mm) Ø24 - 29 (With 0.50mm) | ✓ Dia Range (mm) Ø30 | - |
| | | | Page: J278 | Page: J278 | Page: J278 | Page: J278 | Page: J278 | |
| |  | ✓ Dia Range (mm) Ø12.5 - 13.5 (With 0.50mm) | ✓ Dia Range (mm) Ø14 - 16 (With 0.50mm) | ✓ Dia Range (mm) Ø16.5 - 19.5 (With 0.50mm) | ✓ Dia Range (mm) Ø20 - 23.5 (With 0.50mm) | ✓ Dia Range (mm) Ø24 - 29.5 (With 0.50mm) | ✓ Dia Range (mm) Ø30-35 | ✓ Dia Range (mm) Ø36-42 |
| | | Page: J279 | Page: J279 | Page: J279 | Page: J279 | Page: J280 | Page: J280 | Page: J280 |
| |  | ✓ Dia Range (mm) Ø12.5 - 13.5 (With 0.50mm) | ✓ Dia Range (mm) Ø14 - 16 (With 0.50mm) | ✓ Dia Range (mm) Ø16.5 - 19.5 (With 0.50mm) | ✓ Dia Range (mm) Ø20 - 23.5 (With 0.50mm) | ✓ Dia Range (mm) Ø24 - 29.5 (With 0.50mm) | ✓ Dia Range (mm) Ø30 | - |
| | Page: J281 | Page: J281 | Page: J281 | Page: J281 | Page: J281 | Page: J281 | | |
|  | ✓ Dia Range (mm) Ø13 | ✓ Dia Range (mm) Ø14 - 16 | ✓ Dia Range (mm) Ø17 - 19 | ✓ Dia Range (mm) Ø20 - 23 | ✓ Dia Range (mm) Ø24 - 29 | ✓ Dia Range (mm) Ø30 | - | |
| | Page: J282 | Page: J282 | Page: J282 | Page: J282 | Page: J282 | Page: J282 | | |
|   | - | ✓ Dia Range (mm) Ø16 | ✓ Dia Range (mm) Ø17 - 19 | ✓ Dia Range (mm) Ø20 - 23 | ✓ Dia Range (mm) Ø24 - 29 | ✓ Dia Range (mm) Ø30 | - | |
| | | Page: J283 | Page: J283 | Page: J283 | Page: J283 | Page: J283 | | |

| Insert | | SPGT 050204 (PM / EM) ZCC | SPGT 060204 (PM / EM) ZCC | SPGT 07T308 (PM / EM) ZCC | SPGT 090408 (PM / EM) ZCC | SPGT 110408 (PM / EM) ZCC |
|-----------------------------|---|---|---|---|---|---|
| | |  |  |  |  |  |
| Dimeter Range (mm) | | Ø13-15 | Ø15.5-21.5 | Ø22-27 | Ø28-33 | Ø34-40 |
| Size & Diameter Designation |  | - | - | - | - | - |
| |  | ✓ Dia Range (mm) Ø13 - 15 (With 0.50mm) | ✓ Dia Range (mm) Ø15.5 - 21.5 (With 0.50mm) | ✓ Dia Range (mm) Ø22 - 27 (With 0.50mm Up to 24.5) | ✓ Dia Range (mm) Ø28 - 33 | ✓ Dia Range (mm) Ø34 - 40 (With 0.50mm) |
| | | Page: J284 | Page: J284 | Page: J284 | Page: J285 | Page: J285 |
| |  | ✓ Dia Range (mm) Ø13 - 15 | ✓ Dia Range (mm) Ø16 - 21 | ✓ Dia Range (mm) Ø22 - 27 | ✓ Dia Range (mm) Ø28 - 30 | - |
| | | Page: J286 | Page: J286 | Page: J286 | Page: J286 | |
| |  | ✓ Dia Range (mm) Ø13 - 15 | ✓ Dia Range (mm) Ø16 - 21 | ✓ Dia Range (mm) Ø22 - 27 | ✓ Dia Range (mm) Ø28 - 30 | - |
| | | Page: J287 | Page: J287 | Page: J287 | Page: J287 | |
| |  | - | - | - | - | - |
| | | | | | | |

| Insert | | SOMX 050204 | SOMX 060304 | SOMX 070305 | SOMT 09T306 | SOMT 120408 |
|-----------------------------|--|---|---|---|---|---|
| | |  |  |  |  |  |
| Dimeter Range (mm) | | Ø14-17 | Ø18-20 | Ø21-24 | Ø25-34 | Ø35-40 |
| Size & Diameter Designation |  D2 | - | - | - | - | - |
| |  D3 | ✓ Dia Range (mm) Ø14 - 17 | ✓ Dia Range (mm) Ø18 - 20 | ✓ Dia Range (mm) Ø21 - 24 | ✓ Dia Range (mm) Ø25 - 34 | ✓ Dia Range (mm) Ø35 - 40 |
| | | Page: J288 | Page: J288 | Page: J288 | Page: J288 | Page: J288 |
| |  D4 | ✓ Dia Range (mm) Ø14 - 17 | ✓ Dia Range (mm) Ø18 - 20 | ✓ Dia Range (mm) Ø21 - 24 | ✓ Dia Range (mm) Ø25 - 34 | ✓ Dia Range (mm) Ø35 - 40 |
| | | Page: J288 | Page: J288 | Page: J288 | Page: J288 | Page: J288 |
| |  D5 | ✓ Dia Range (mm) Ø14 - 17 | ✓ Dia Range (mm) Ø18 - 20 | ✓ Dia Range (mm) Ø21 - 24 | ✓ Dia Range (mm) Ø25 - 30 | - |
| | | Page: J290 | Page: J290 | Page: J290 | Page: J290 | |
| |  D6 | - | - | - | - | - |
| | | | | | | |

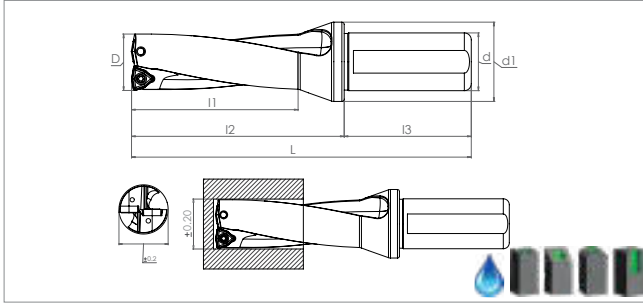
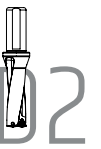

| Ordering Code | Item Designation | | Dimensions (mm) | | | | | | | Price | Master Insert* |
|---------------|---|------------------------|-----------------|----|----|-----|----|----|----|-------|----------------|
| | SDUM Dx2 - WCM. 030208 / 040208 / 050308 U-DRILL | POWER SERIES | D | d | d1 | L | l1 | l2 | l3 | EURO | |
| SM16248 | SDUM 16xD2 WCM.030208 | ✓ | 16 | 25 | 34 | 108 | 32 | 52 | 56 | 122 € | WCM. 030208 |
| SM16255 | SDUM 16.5xD2 WCM.030208 | ✓ | 16.5 | 25 | 34 | 110 | 33 | 54 | 56 | 122 € | |
| SM16262 | SDUM 17xD2 WCM.030208 | ✓ | 17 | 25 | 34 | 110 | 34 | 54 | 56 | 122 € | |
| SM16279 | SDUM 17.5xD2 WCM.030208 | ✓ | 17.5 | 25 | 34 | 113 | 35 | 57 | 56 | 122 € | |
| SM16286 | SDUM 18xD2 WCM.030208 | ✓ | 18 | 25 | 34 | 113 | 36 | 57 | 56 | 122 € | |
| SM16293 | SDUM 18.5xD2 WCM.030208 | ✓ | 18.5 | 25 | 34 | 115 | 37 | 59 | 56 | 122 € | |
| SM16323 | SDUM 19xD2 WCM.030208 | ✓ | 19 | 25 | 34 | 115 | 38 | 59 | 56 | 138 € | |
| SM16330 | SDUM 19.5xD2 WCM.030208 | ✓ | 19.5 | 25 | 34 | 119 | 39 | 63 | 56 | 138 € | |
| SM17016 | SDUM 20xD2 WCM.040208 | ✓ | 20 | 25 | 34 | 119 | 40 | 63 | 56 | 138 € | |
| SM17061 | SDUM 20.5xD2 WCM.040208 | ✓ | 20.5 | 25 | 34 | 121 | 41 | 65 | 56 | 138 € | |
| SM17023 | SDUM 21xD2 WCM.040208 | ✓ | 21 | 25 | 34 | 121 | 42 | 65 | 56 | 138 € | |
| SM17047 | SDUM 21.5xD2 WCM.040208 | ✓ | 21.5 | 25 | 34 | 123 | 43 | 67 | 56 | 138 € | |
| SM17030 | SDUM 22xD2 WCM.040208 | ✓ | 22 | 25 | 34 | 123 | 44 | 67 | 56 | 138 € | |
| SM17054 | SDUM 22.5xD2 WCM.040208 | ✓ | 22.5 | 25 | 34 | 127 | 45 | 71 | 56 | 138 € | |
| SM17078 | SDUM 23xD2 WCM.040208 | ✓ | 23 | 25 | 34 | 127 | 46 | 71 | 56 | 142 € | |
| SM17085 | SDUM 23.5xD2 WCM.040208 | ✓ | 23.5 | 25 | 34 | 130 | 47 | 74 | 56 | 142 € | WCM. 050308 |
| SM16545 | SDUM 24xD2 WCM.050308 | ✓ | 24 | 25 | 44 | 130 | 48 | 74 | 56 | 142 € | |
| SM17290 | SDUM 24.5xD2 WCM.050308 | ✓ | 24.5 | 25 | 44 | 133 | 49 | 77 | 56 | 142 € | |
| SM17092 | SDUM 25xD2 WCM.050308 | ✓ | 25 | 25 | 44 | 133 | 50 | 77 | 56 | 142 € | |
| SM17320 | SDUM 25.5xD2 WCM.050308 | ✓ | 25.5 | 25 | 44 | 135 | 51 | 79 | 56 | 142 € | |
| SM17108 | SDUM 26xD2 WCM.050308 | ✓ | 26 | 25 | 44 | 135 | 52 | 79 | 56 | 142 € | |
| SM17306 | SDUM 26.5xD2 WCM.050308 | ✓ | 26.5 | 25 | 44 | 137 | 53 | 81 | 56 | 142 € | |
| SM17115 | SDUM 27xD2 WCM.050308 | ✓ | 27 | 25 | 44 | 137 | 54 | 81 | 56 | 142 € | |
| SM17313 | SDUM 27.5xD2 WCM.050308 | ✓ | 27.5 | 25 | 44 | 140 | 55 | 84 | 56 | 142 € | |
| SM17122 | SDUM 28xD2 WCM.050308 | ✓ | 28 | 25 | 44 | 140 | 56 | 84 | 56 | 142 € | |
| SM16996 | SDUM 28.5xD2 WCM.050308 | ✓ | 28.5 | 25 | 44 | 142 | 57 | 86 | 56 | 149 € | |
| SM17139 | SDUM 29xD2 WCM.050308 | ✓ | 29 | 25 | 44 | 142 | 58 | 86 | 56 | 149 € | |
| SM17009 | SDUM 29.5xD2 WCM.050308 | ✓ | 29.5 | 25 | 44 | 151 | 59 | 91 | 56 | 149 € | |

| Size Designation | Master Insert* | Spare Parts | | |
|------------------|----------------|---------------------|------------------|--------------------|
| | | Screw | Torx Key | Screw Torque Value |
| D16 - D23.5 | WCM. 030208 | SSV M2.5x6-9505 | STK-T08-9908 | N-m 1,2 |
| | WCM. 040208 | | | |
| D24 - D29.5 | WCM. 050308 | SSV M3x8-9508 | | 1,9 |

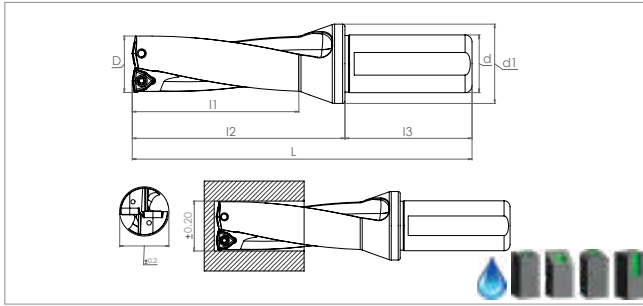

| Ordering Code | Item Designation | POWER SERIES | Dimensions (mm) | | | | | | | Price | Master Insert* | |
|---------------|--|--------------|-----------------|----|----|-----|-----|-----|----|-------|----------------|------|
| | | | D | d | d1 | L | l1 | l2 | l3 | | | EURO |
| | SDUM Dx2 - WCM. 06T308/080412 U-DRILL | | | | | | | | | | | |
| SM17146 | SDUM 30XD2 WCM.06T308 | ✓ | 30 | 32 | 44 | 141 | 60 | 81 | 60 | 155 € | WCM. 06T308 | |
| SM17153 | SDUM 31XD2 WCM.06T308 | ✓ | 31 | 32 | 44 | 144 | 62 | 83 | 60 | 155 € | | |
| SM17160 | SDUM 32XD2 WCM.06T308 | ✓ | 32 | 32 | 44 | 146 | 64 | 86 | 60 | 155 € | | |
| SM17177 | SDUM 33XD2 WCM.06T308 | ✓ | 33 | 32 | 44 | 149 | 66 | 88 | 60 | 155 € | | |
| SM17184 | SDUM 34XD2 WCM.06T308 | ✓ | 34 | 32 | 44 | 151 | 68 | 91 | 60 | 155 € | | |
| SM17191 | SDUM 35XD2 WCM.06T308 | ✓ | 35 | 32 | 44 | 154 | 70 | 93 | 60 | 155 € | | |
| SM17207 | SDUM 36XD2 WCM.06T308 | ✓ | 36 | 32 | 44 | 157 | 72 | 96 | 60 | 155 € | | |
| SM17214 | SDUM 37XD2 WCM.06T308 | ✓ | 37 | 32 | 44 | 160 | 74 | 100 | 60 | 155 € | | |
| SM17221 | SDUM 38XD2 WCM.06T308 | ✓ | 38 | 32 | 44 | 163 | 76 | 103 | 60 | 165 € | | |
| SM17238 | SDUM 39XD2 WCM.06T308 | ✓ | 39 | 32 | 44 | 165 | 78 | 105 | 60 | 165 € | | |
| SM17245 | SDUM 40XD2 WCM.06T308 | ✓ | 40 | 32 | 44 | 168 | 80 | 108 | 60 | 165 € | | |
| SM17252 | SDUM 41XD2 WCM.06T308 | ✓ | 41 | 32 | 44 | 171 | 82 | 110 | 60 | 165 € | | |
| SM17269 | SDUM 42XD2 WCM.06T308 | ✓ | 42 | 32 | 44 | 173 | 84 | 112 | 60 | 165 € | | |
| SM17276 | SDUM 43XD2 WCM.06T308 | ✓ | 43 | 32 | 44 | 176 | 86 | 114 | 60 | 165 € | | |
| SM17283 | SDUM 44XD2 WCM.06T308 | ✓ | 44 | 32 | 44 | 178 | 88 | 117 | 60 | 165 € | | |
| SM17337 | SDUM 45XD2 WCM.080412 | ✓ | 45 | 40 | 60 | 192 | 90 | 123 | 70 | 174 € | WCM. 080412 | |
| SM17368 | SDUM 46XD2 WCM.080412 | ✓ | 46 | 40 | 60 | 195 | 92 | 125 | 70 | 181 € | | |
| SM17375 | SDUM 47XD2 WCM.080412 | ✓ | 47 | 40 | 60 | 197 | 94 | 127 | 70 | 181 € | | |
| SM17399 | SDUM 48XD2 WCM.080412 | ✓ | 48 | 40 | 60 | 200 | 96 | 130 | 70 | 185 € | | |
| SM17412 | SDUM 49XD2 WCM.080412 | ✓ | 49 | 40 | 60 | 202 | 98 | 132 | 70 | 194 € | | |
| SM17436 | SDUM 50XD2 WCM.080412 | ✓ | 50 | 40 | 60 | 205 | 100 | 135 | 70 | 200 € | | |
| SM17443 | SDUM 51XD2 WCM.080412 | ✓ | 51 | 40 | 60 | 207 | 102 | 137 | 70 | 212 € | | |
| SM17467 | SDUM 52XD2 WCM.080412 | ✓ | 52 | 40 | 60 | 210 | 104 | 140 | 70 | 221 € | | |
| SM17528 | SDUM 53XD2 WCM.080412 | ✓ | 53 | 40 | 60 | 212 | 106 | 142 | 70 | 230 € | | |
| SM17573 | SDUM 54XD2 WCM.080412 | ✓ | 54 | 40 | 60 | 215 | 108 | 145 | 70 | 236 € | | |
| SM17597 | SDUM 55XD2 WCM.080412 | ✓ | 55 | 40 | 60 | 217 | 110 | 147 | 70 | 244 € | | |
| SM17672 | SDUM 56XD2 WCM.080412 | ✓ | 56 | 40 | 60 | 220 | 112 | 150 | 70 | 256 € | | |
| SM17696 | SDUM 57XD2 WCM.080412 | ✓ | 57 | 40 | 60 | 222 | 114 | 152 | 70 | 263 € | | |
| SM17757 | SDUM 58XD2 WCM.080412 | ✓ | 58 | 40 | 60 | 225 | 116 | 155 | 70 | 274 € | | |
| SM17788 | SDUM 59XD2 WCM.080412 | ✓ | 59 | 40 | 60 | 227 | 118 | 157 | 70 | 283 € | | |
| SM17801 | SDUM 60XD2 WCM.080412 | ✓ | 60 | 40 | 60 | 230 | 120 | 160 | 70 | 291 € | | |

| Size Designation | Master Insert* | Spare Parts | | |
|------------------|----------------|----------------------|------------------|--------------------|
| | | Screw | Torx Key | Screw Torque Value |
| D30 - D44 | | SSV M3.5x10-9511 | STK-T15-9910 | N-m 2,9 |
| D45 - D60 | | SSV M4x10-9514 | | N-m 4,3 |

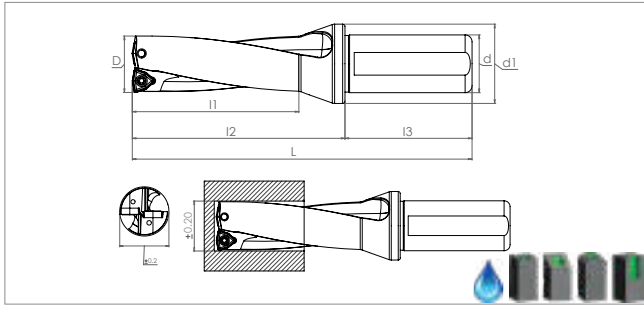
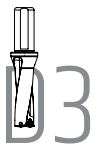

| Ordering Code | Item Designation | Dimensions (mm) | | | | | | | | Price | Master Insert* |
|---------------|---|------------------------|------|----|----|-----|------|-----|----|-------|----------------|
| | SDUM Dx3 - WCM. 030208 / 040208 / 050308 U-DRILL | POWER SERIES | D | d | d1 | L | l1 | l2 | l3 | EURO | |
| SM16309 | SDUM 16XD3 WCM.030208 | ✓ | 16 | 25 | 34 | 124 | 48 | 68 | 56 | 133 € | WCM. 030208 |
| SM16187 | SDUM 16.5XD3 WCM.030208 | ✓ | 16.5 | 25 | 34 | 127 | 49.5 | 71 | 56 | 133 € | |
| SM16194 | SDUM 17XD3 WCM.030208 | ✓ | 17 | 25 | 34 | 127 | 51 | 71 | 56 | 133 € | |
| SM16200 | SDUM 17.5XD3 WCM.030208 | ✓ | 17.5 | 25 | 34 | 131 | 52.5 | 75 | 56 | 133 € | |
| SM16217 | SDUM 18XD3 WCM.030208 | ✓ | 18 | 25 | 34 | 131 | 54 | 75 | 56 | 133 € | |
| SM16224 | SDUM 18.5XD3 WCM.030208 | ✓ | 18.5 | 25 | 34 | 134 | 55.5 | 78 | 56 | 133 € | |
| SM16231 | SDUM 19XD3 WCM.030208 | ✓ | 19 | 25 | 34 | 134 | 57 | 78 | 56 | 133 € | |
| SM16316 | SDUM 19.5XD3 WCM.030208 | ✓ | 19.5 | 25 | 34 | 139 | 58.5 | 83 | 56 | 133 € | |
| SM16347 | SDUM 20XD3 WCM.040208 | ✓ | 20 | 25 | 34 | 139 | 60 | 83 | 56 | 138 € | WCM. 040208 |
| SM16354 | SDUM 20.5XD3 WCM.040208 | ✓ | 20.5 | 25 | 34 | 142 | 61.5 | 88 | 56 | 138 € | |
| SM16361 | SDUM 21XD3 WCM.040208 | ✓ | 21 | 25 | 34 | 142 | 63 | 88 | 56 | 138 € | |
| SM16378 | SDUM 21.5XD3 WCM.040208 | ✓ | 21.5 | 25 | 34 | 145 | 64.5 | 89 | 56 | 138 € | |
| SM16385 | SDUM 22XD3 WCM.040208 | ✓ | 22 | 25 | 34 | 145 | 66 | 89 | 56 | 138 € | |
| SM16392 | SDUM 22.5XD3 WCM.040208 | ✓ | 22.5 | 25 | 34 | 150 | 67.5 | 94 | 56 | 138 € | |
| SM16408 | SDUM 23XD3 WCM.040208 | ✓ | 23 | 25 | 34 | 150 | 69 | 94 | 56 | 138 € | |
| SM16415 | SDUM 23.5XD3 WCM.040208 | ✓ | 23.5 | 25 | 34 | 154 | 70.5 | 98 | 56 | 138 € | |
| SM16422 | SDUM 24XD3 WCM.050308 | ✓ | 24 | 25 | 34 | 154 | 72 | 98 | 56 | 142 € | WCM. 050308 |
| SM16439 | SDUM 24.5XD3 WCM.050308 | ✓ | 24.5 | 25 | 34 | 158 | 73.5 | 102 | 56 | 142 € | |
| SM16446 | SDUM 25XD3 WCM.050308 | ✓ | 25 | 25 | 34 | 158 | 75 | 102 | 56 | 142 € | |
| SM16453 | SDUM 25.5XD3 WCM.050308 | ✓ | 25.5 | 25 | 34 | 161 | 76.5 | 105 | 56 | 142 € | |
| SM16460 | SDUM 26XD3 WCM.050308 | ✓ | 26 | 25 | 34 | 161 | 78 | 105 | 56 | 142 € | |
| SM16477 | SDUM 26.5XD3 WCM.050308 | ✓ | 26.5 | 25 | 34 | 164 | 79.5 | 108 | 56 | 142 € | |
| SM16484 | SDUM 27XD3 WCM.050308 | ✓ | 27 | 25 | 34 | 164 | 81 | 108 | 56 | 142 € | |
| SM16491 | SDUM 27.5XD3 WCM.050308 | ✓ | 27.5 | 25 | 34 | 168 | 82.5 | 112 | 56 | 142 € | |
| SM16507 | SDUM 28XD3 WCM.050308 | ✓ | 28 | 25 | 34 | 168 | 84 | 112 | 56 | 142 € | |
| SM16514 | SDUM 28.5XD3 WCM.050308 | ✓ | 28.5 | 25 | 34 | 171 | 85.5 | 115 | 56 | 142 € | |
| SM16521 | SDUM 29XD3 WCM.050308 | ✓ | 29 | 25 | 34 | 171 | 87 | 115 | 56 | 142 € | |
| SM16538 | SDUM 29.5XD3 WCM.050308 | ✓ | 29.5 | 25 | 34 | 177 | 88.5 | 111 | 56 | 142 € | |

| Size Designation | Master Insert* | Spare Parts | | |
|------------------|----------------|-------------|----------|--------------------|
| | | Screw | Torx Key | Screw Torque Value |
| D16 - D23.5 | WCM. 030208 | | | N-m |
| | WCM. 040208 | | | |
| D24 - D29.5 | WCM. 050308 | | | |

Continued on next page
Devami sonraki sayfada

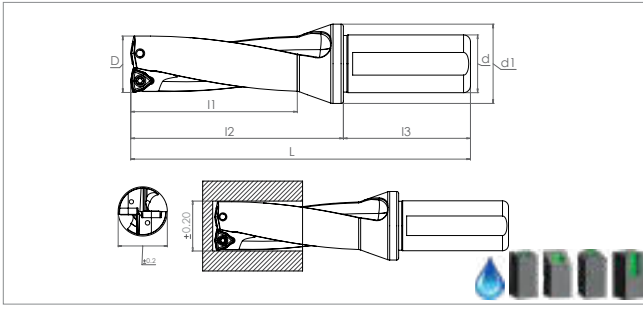

| Ordering Code | Item Designation | POWER SERIES | Dimensions (mm) | | | | | | | Price | Master Insert* | |
|---------------|--|--------------|-----------------|----|----|-----|-----|-----|----|-------|----------------|------|
| | | | D | d | d1 | L | l1 | l2 | l3 | | | EURO |
| | SDUM Dx3 - WCM. 06T308 / 080412 U-DRILL | | | | | | | | | | | |
| SM16552 | SDUM 30XD3 WCM.06T308 | ✓ | 30 | 32 | 44 | 171 | 90 | 111 | 60 | 152 € | WCM. 06T308 | |
| SM16569 | SDUM 31XD3 WCM.06T308 | ✓ | 31 | 32 | 44 | 175 | 93 | 115 | 60 | 152 € | | |
| SM16576 | SDUM 32XD3 WCM.06T308 | ✓ | 32 | 32 | 44 | 178 | 96 | 118 | 60 | 152 € | | |
| SM16583 | SDUM 33XD3 WCM.06T308 | ✓ | 33 | 32 | 44 | 182 | 99 | 122 | 60 | 152 € | | |
| SM16590 | SDUM 34XD3 WCM.06T308 | ✓ | 34 | 32 | 44 | 185 | 102 | 125 | 60 | 152 € | | |
| SM16606 | SDUM 35XD3 WCM.06T308 | ✓ | 35 | 32 | 44 | 189 | 105 | 129 | 60 | 152 € | | |
| SM16613 | SDUM 36XD3 WCM.06T308 | ✓ | 36 | 32 | 44 | 193 | 108 | 133 | 60 | 152 € | | |
| SM16620 | SDUM 37XD3 WCM.06T308 | ✓ | 37 | 32 | 44 | 197 | 111 | 136 | 60 | 152 € | | |
| SM16637 | SDUM 38XD3 WCM.06T308 | ✓ | 38 | 32 | 44 | 201 | 114 | 141 | 60 | 152 € | | |
| SM16644 | SDUM 39XD3 WCM.06T308 | ✓ | 39 | 32 | 44 | 204 | 117 | 144 | 60 | 152 € | | |
| SM16651 | SDUM 40XD3 WCM.06T308 | ✓ | 40 | 32 | 44 | 208 | 120 | 148 | 60 | 165 € | | |
| SM16668 | SDUM 41XD3 WCM.06T308 | ✓ | 41 | 32 | 44 | 212 | 123 | 152 | 60 | 165 € | | |
| SM16675 | SDUM 42XD3 WCM.06T308 | ✓ | 42 | 32 | 44 | 215 | 126 | 155 | 60 | 165 € | | |
| SM16682 | SDUM 43XD3 WCM.06T308 | ✓ | 43 | 32 | 44 | 219 | 129 | 158 | 60 | 165 € | | |
| SM16699 | SDUM 44XD3 WCM.06T308 | ✓ | 44 | 32 | 44 | 222 | 132 | 162 | 60 | 165 € | | |
| SM17344 | SDUM 45XD3 WCM.080412 | ✓ | 45 | 40 | 60 | 237 | 135 | 167 | 70 | 174 € | WCM. 080412 | |
| SM17351 | SDUM 46XD3 WCM.080412 | ✓ | 46 | 40 | 60 | 241 | 138 | 171 | 70 | 176 € | | |
| SM17382 | SDUM 47XD3 WCM.080412 | ✓ | 47 | 40 | 60 | 244 | 141 | 174 | 70 | 185 € | | |
| SM17405 | SDUM 48XD3 WCM.080412 | ✓ | 48 | 40 | 60 | 248 | 144 | 178 | 70 | 194 € | | |
| SM17429 | SDUM 49XD3 WCM.080412 | ✓ | 49 | 40 | 60 | 251 | 147 | 181 | 70 | 200 € | | |
| SM17450 | SDUM 50XD3 WCM.080412 | ✓ | 50 | 40 | 60 | 255 | 150 | 185 | 70 | 212 € | | |
| SM17474 | SDUM 51XD3 WCM.080412 | ✓ | 51 | 40 | 60 | 258 | 153 | 188 | 70 | 221 € | | |
| SM17535 | SDUM 52XD3 WCM.080412 | ✓ | 52 | 40 | 60 | 261 | 156 | 191 | 70 | 233 € | | |
| SM17580 | SDUM 53XD3 WCM.080412 | ✓ | 53 | 40 | 60 | 264 | 159 | 194 | 70 | 244 € | | |
| SM17658 | SDUM 54XD3 WCM.080412 | ✓ | 54 | 40 | 60 | 267 | 162 | 197 | 70 | 251 € | | |
| SM17689 | SDUM 55XD3 WCM.080412 | ✓ | 55 | 40 | 60 | 270 | 165 | 200 | 70 | 263 € | | |
| SM17740 | SDUM 56XD3 WCM.080412 | ✓ | 56 | 40 | 60 | 273 | 168 | 203 | 70 | 272 € | | |
| SM17764 | SDUM 57XD3 WCM.080412 | ✓ | 57 | 40 | 60 | 276 | 171 | 206 | 70 | 280 € | | |
| SM17795 | SDUM 58XD3 WCM.080412 | ✓ | 58 | 40 | 60 | 279 | 174 | 209 | 70 | 292 € | | |
| SM17825 | SDUM 59XD3 WCM.080412 | ✓ | 59 | 40 | 60 | 282 | 177 | 211 | 70 | 299 € | | |
| SM17832 | SDUM 60XD3 WCM.080412 | ✓ | 60 | 40 | 60 | 285 | 180 | 214 | 70 | 307 € | | |

| Size Designation | Master Insert* | Spare Parts | | |
|------------------|----------------|----------------------|------------------|--------------------|
| | | Screw | Torx Key | Screw Torque Value |
| D30 - D44 | | SSV M3.5x10-9511 | STK-T15-9910 | 2,9 |
| D45 - D60 | | SSV M4x10-9514 | | 4,3 |

*Suitable Insert is ISO

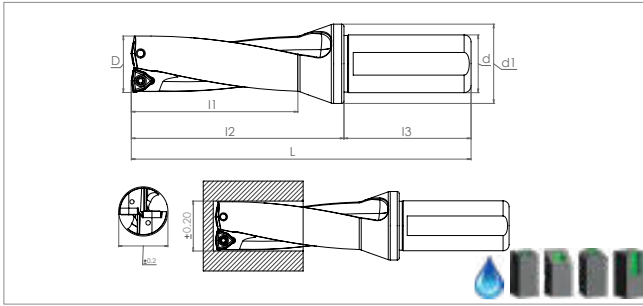

| Ordering Code | Item Designation | POWER SERIES | Dimensions (mm) | | | | | | | Price | Master Insert* | | |
|---------------|---|--------------|-----------------|----|----|-----|-----|-----|----|-------|----------------|------|-------------|
| | | | D | d | d1 | L | l1 | l2 | l3 | | | EURO | |
| | SDUM Dx4 - WCM. - ISO 030208 / 040208 / 050308 U-DRILL | | | | | | | | | | | | |
| SM16712 | SDUM 16XD4 WCM.030208 | ✓ | 16 | 25 | 34 | 140 | 64 | 84 | 56 | 174 € | WCM. 030208 | | |
| SM17887 | SDUM 16.5XD4 WCM.030208 | ✓ | 16.5 | 25 | 34 | 144 | 66 | 84 | 56 | 174 € | | | |
| SM16729 | SDUM 17XD4 WCM.030208 | ✓ | 17 | 25 | 34 | 144 | 68 | 88 | 56 | 174 € | | | |
| SM17894 | SDUM 17.5XD4 WCM.030208 | ✓ | 17.5 | 25 | 34 | 149 | 70 | 88 | 56 | 174 € | | | |
| SM16705 | SDUM 18XD4 WCM.030208 | ✓ | 18 | 25 | 34 | 149 | 72 | 93 | 56 | 174 € | | | |
| SM17900 | SDUM 18.5XD4 WCM.030208 | ✓ | 18.5 | 25 | 34 | 153 | 74 | 93 | 56 | 174 € | | | |
| SM16736 | SDUM 19XD4 WCM.030208 | ✓ | 19 | 25 | 34 | 153 | 76 | 97 | 56 | 174 € | | | |
| SM17917 | SDUM 19.5XD4 WCM.030208 | ✓ | 19.5 | 25 | 34 | 159 | 78 | 97 | 56 | 174 € | | | |
| SM16743 | SDUM 20XD4 WCM.040208 | ✓ | 20 | 25 | 34 | 159 | 80 | 103 | 56 | 185 € | | | WCM. 040208 |
| SM17863 | SDUM 20.5XD4 WCM.040208 | ✓ | 20.5 | 25 | 34 | 163 | 82 | 103 | 56 | 185 € | | | |
| SM16750 | SDUM 21XD4 WCM.040208 | ✓ | 21 | 25 | 34 | 163 | 84 | 107 | 56 | 185 € | | | |
| SM17924 | SDUM 21.5XD4 WCM.040208 | ✓ | 21.5 | 25 | 34 | 167 | 86 | 107 | 56 | 185 € | | | |
| SM16767 | SDUM 22XD4 WCM.040208 | ✓ | 22 | 25 | 34 | 167 | 88 | 111 | 56 | 185 € | | | |
| SM17870 | SDUM 22.5XD4 WCM.040208 | ✓ | 22.5 | 25 | 34 | 173 | 90 | 111 | 56 | 185 € | | | |
| SM16774 | SDUM 23XD4 WCM.040208 | ✓ | 23 | 25 | 34 | 173 | 92 | 117 | 56 | 185 € | | | |
| SM17931 | SDUM 23.5XD4 WCM.040208 | ✓ | 23.5 | 25 | 34 | 178 | 94 | 117 | 56 | 185 € | | | |
| SM16781 | SDUM 24XD4 WCM.050308 | ✓ | 24 | 25 | 34 | 178 | 96 | 122 | 56 | 196 € | WCM. 050308 | | |
| SM17948 | SDUM 24.5XD4 WCM.050308 | ✓ | 24.5 | 25 | 34 | 183 | 98 | 122 | 56 | 196 € | | | |
| SM16798 | SDUM 25XD4 WCM.050308 | ✓ | 25 | 25 | 34 | 183 | 100 | 127 | 56 | 196 € | | | |
| SM17955 | SDUM 25.5XD4 WCM.050308 | ✓ | 25.5 | 25 | 34 | 187 | 102 | 127 | 56 | 196 € | | | |
| SM16804 | SDUM 26XD4 WCM.050308 | ✓ | 26 | 25 | 34 | 187 | 104 | 131 | 56 | 196 € | | | |
| SM17962 | SDUM 26.5XD4 WCM.050308 | ✓ | 26.5 | 25 | 34 | 191 | 106 | 131 | 56 | 196 € | | | |
| SM16811 | SDUM 27XD4 WCM.050308 | ✓ | 27 | 25 | 34 | 191 | 108 | 135 | 56 | 196 € | | | |
| SM17979 | SDUM 27.5XD4 WCM.050308 | ✓ | 27.5 | 25 | 34 | 196 | 110 | 135 | 56 | 196 € | | | |
| SM16828 | SDUM 28XD4 WCM.050308 | ✓ | 28 | 25 | 34 | 196 | 112 | 140 | 56 | 196 € | | | |
| SM17986 | SDUM 28.5XD4 WCM.050308 | ✓ | 28.5 | 25 | 34 | 200 | 114 | 140 | 56 | 196 € | | | |
| SM16835 | SDUM 29XD4 WCM.050308 | ✓ | 29 | 25 | 34 | 200 | 116 | 144 | 56 | 196 € | WCM. 050308 | | |
| SM17993 | SDUM 29.5XD4 WCM.050308 | ✓ | 29.5 | 25 | 34 | 202 | 118 | 144 | 56 | 196 € | | | |

| Size Designation | Master Insert* | Spare Parts | | |
|------------------|----------------|-----------------|--------------|--------------------|
| | | Screw | Torx Key | Screw Torque Value |
| D16 - D23.5 | | | | |
| | WCM. 030208 | SSV M2.5x6-9505 | STK-T08-9908 | 1,2 |
| WCM. 040208 | | | | |
| D24 - D29.5 | WCM. 050308 | SSV M3x8-9508 | | 1,9 |

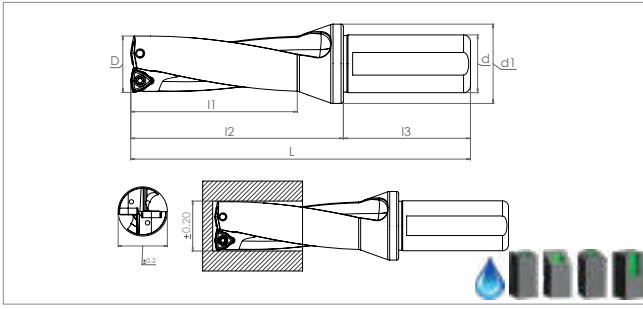

| Ordering Code | Item Designation | POWER SERIES | Dimensions (mm) | | | | | | | Price | Master Insert* | |
|---------------|--|--------------|-----------------|----|----|-----|-----|-----|----|-------|----------------|------|
| | | | D | d | d1 | L | l1 | l2 | l3 | | | EURO |
| | SDUM Dx4 - WCM. - ISO 06T308 / 080412 U-DRILL | | | | | | | | | | | |
| SM16842 | SDUM 30XD4 WCM.06T308 | ✓ | 30 | 32 | 44 | 201 | 120 | 141 | 60 | 208 € | WCM.06T308 | |
| SM16859 | SDUM 31XD4 WCM.06T308 | ✓ | 31 | 32 | 44 | 206 | 124 | 145 | 60 | 208 € | | |
| SM16866 | SDUM 32XD4 WCM.06T308 | ✓ | 32 | 32 | 44 | 210 | 128 | 149 | 60 | 208 € | | |
| SM16873 | SDUM 33XD4 WCM.06T308 | ✓ | 33 | 32 | 44 | 215 | 132 | 154 | 60 | 208 € | | |
| SM20931 | SDUM 33.5XD4 WCM.06T308 | ✓ | 33.5 | 32 | 44 | 219 | 134 | 158 | 60 | 208 € | | |
| SM16880 | SDUM 34XD4 WCM.06T308 | ✓ | 34 | 32 | 44 | 219 | 136 | 158 | 60 | 208 € | | |
| SM16897 | SDUM 35XD4 WCM.06T308 | ✓ | 35 | 32 | 44 | 224 | 140 | 166 | 60 | 208 € | | |
| SM16903 | SDUM 36XD4 WCM.06T308 | ✓ | 36 | 32 | 44 | 229 | 144 | 169 | 60 | 208 € | | |
| SM16910 | SDUM 37XD4 WCM.06T308 | ✓ | 37 | 32 | 44 | 234 | 148 | 172 | 60 | 208 € | | |
| SM16927 | SDUM 38XD4 WCM.06T308 | ✓ | 38 | 32 | 44 | 239 | 152 | 178 | 60 | 208 € | | |
| SM25394 | SDUM 38.5XD4 WCM.06T308 | ✓ | 38.5 | 32 | 44 | 243 | 154 | 181 | 60 | 208 € | | |
| SM16934 | SDUM 39XD4 WCM.06T308 | ✓ | 39 | 32 | 44 | 243 | 156 | 181 | 60 | 208 € | | |
| SM16941 | SDUM 40XD4 WCM.06T308 | ✓ | 40 | 32 | 44 | 248 | 160 | 188 | 60 | 244 € | | |
| SM16958 | SDUM 41XD4 WCM.06T308 | ✓ | 41 | 32 | 44 | 253 | 164 | 191 | 60 | 244 € | | |
| SM16965 | SDUM 42XD4 WCM.06T308 | ✓ | 42 | 32 | 44 | 257 | 168 | 195 | 60 | 244 € | | |
| SM16972 | SDUM 43XD4 WCM.06T308 | ✓ | 43 | 32 | 44 | 262 | 172 | 197 | 60 | 244 € | | |
| SM16989 | SDUM 44XD4 WCM.06T308 | ✓ | 44 | 32 | 44 | 266 | 176 | 200 | 60 | 244 € | | |
| SM17665 | SDUM 45XD4 WCM.080412 | ✓ | 45 | 40 | 60 | 272 | 180 | 202 | 70 | 256 € | WCM.080412 | |
| SM17726 | SDUM 46XD4 WCM.080412 | ✓ | 46 | 40 | 60 | 276 | 184 | 206 | 70 | 269 € | | |
| SM17771 | SDUM 47XD4 WCM.080412 | ✓ | 47 | 40 | 60 | 280 | 188 | 210 | 70 | 280 € | | |
| SM17818 | SDUM 48XD4 WCM.080412 | ✓ | 48 | 40 | 60 | 284 | 192 | 214 | 70 | 292 € | | |
| SM17849 | SDUM 49XD4 WCM.080412 | ✓ | 49 | 40 | 60 | 288 | 196 | 218 | 70 | 307 € | | |
| SM17856 | SDUM 50XD4 WCM.080412 | ✓ | 50 | 40 | 60 | 292 | 200 | 221 | 70 | 323 € | | |

| Size Designation | Master Insert* | Spare Parts | | |
|------------------|----------------|------------------|--------------|--------------------|
| | | Screw | Torx Key | Screw Torque Value |
| D30 - D44 | | SSV M3.5x10-9511 | | N-m |
| D45 - D60 | | SSV M4x10-9514 | STK-T15-9910 | 4,3 |

*Suitable Insert is ISO

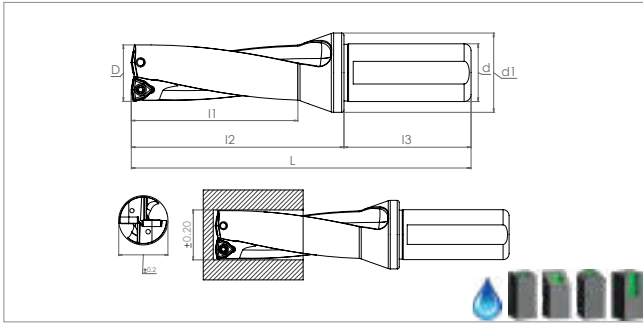

| Ordering Code | Item Designation | POWER SERIES | Dimensions (mm) | | | | | | | Price | Master Insert* | |
|---------------|--|--------------|-----------------|----|----|-----|-----|-----|----|-------|----------------|--|
| | | | D | d | d1 | L | l1 | l2 | l3 | | | |
| | SDUM Dx5 - WCM. 030208 / 040208 / 050308 / 06T308 U-DRILL | | | | | | | | | | EURO | |
| SM17481 | SDUM 16XD5 WCM.030208 | ✓ | 16 | 25 | 34 | 155 | 80 | 100 | 56 | 220 € | WCM. 030208 | |
| SM17498 | SDUM 17XD5 WCM.030208 | ✓ | 17 | 25 | 34 | 160 | 85 | 105 | 56 | 220 € | | |
| SM17504 | SDUM 18XD5 WCM.030208 | ✓ | 18 | 25 | 34 | 165 | 90 | 111 | 56 | 220 € | | |
| SM17511 | SDUM 19XD5 WCM.030208 | ✓ | 19 | 25 | 34 | 170 | 95 | 116 | 56 | 233 € | WCM. 040208 | |
| SM17542 | SDUM 20XD5 WCM.040208 | ✓ | 20 | 25 | 34 | 175 | 100 | 120 | 56 | 233 € | | |
| SM17559 | SDUM 21XD5 WCM.040208 | ✓ | 21 | 25 | 34 | 180 | 105 | 124 | 56 | 233 € | | |
| SM17566 | SDUM 22XD5 WCM.040208 | ✓ | 22 | 25 | 34 | 185 | 110 | 129 | 56 | 233 € | WCM. 050308 | |
| SM17603 | SDUM 23XD5 WCM.040208 | ✓ | 23 | 25 | 34 | 190 | 115 | 135 | 56 | 245 € | | |
| SM17610 | SDUM 24XD5 WCM.050308 | ✓ | 24 | 25 | 34 | 195 | 120 | 140 | 56 | 245 € | | |
| SM17627 | SDUM 25XD5 WCM.050308 | ✓ | 25 | 25 | 34 | 200 | 125 | 144 | 56 | 245 € | WCM. 06T308 | |
| SM17634 | SDUM 26XD5 WCM.050308 | ✓ | 26 | 25 | 34 | 205 | 130 | 149 | 56 | 245 € | | |
| SM17641 | SDUM 27XD5 WCM.050308 | ✓ | 27 | 25 | 34 | 210 | 135 | 155 | 56 | 245 € | | |
| SM17702 | SDUM 28XD5 WCM.050308 | ✓ | 28 | 25 | 34 | 215 | 140 | 160 | 56 | 245 € | WCM. 06T308 | |
| SM17719 | SDUM 29XD5 WCM.050308 | ✓ | 29 | 25 | 34 | 220 | 145 | 165 | 56 | 245 € | | |
| SM17733 | SDUM 30XD5 WCM.06T308 | ✓ | 30 | 32 | 44 | 231 | 150 | 170 | 60 | 245 € | | |
| SM26162 | SDUM 31XD5 WCM.06T308 | ✓ | 31 | 32 | 44 | 136 | 155 | 173 | 60 | 254 € | WCM. 06T308 | |
| SM26179 | SDUM 32XD5 WCM.06T308 | ✓ | 32 | 32 | 44 | 241 | 160 | 180 | 60 | 254 € | | |
| SM26186 | SDUM 33XD5 WCM.06T308 | ✓ | 33 | 32 | 44 | 246 | 165 | 185 | 60 | 254 € | | |
| SM26193 | SDUM 34XD5 WCM.06T308 | ✓ | 34 | 32 | 44 | 251 | 170 | 190 | 60 | 254 € | | |
| SM26209 | SDUM 35XD5 WCM.06T308 | ✓ | 35 | 32 | 44 | 256 | 175 | 195 | 60 | 273 € | | |
| SM26216 | SDUM 36XD5 WCM.06T308 | ✓ | 36 | 32 | 44 | 261 | 180 | 200 | 60 | 273 € | | |
| SM26223 | SDUM 37XD5 WCM.06T308 | ✓ | 37 | 32 | 44 | 266 | 185 | 205 | 60 | 273 € | | |
| SM26230 | SDUM 38XD5 WCM.06T308 | ✓ | 38 | 32 | 44 | 271 | 190 | 210 | 60 | 308 € | | |
| SM26247 | SDUM 39XD5 WCM.06T308 | ✓ | 39 | 32 | 44 | 276 | 195 | 215 | 60 | 308 € | | |
| SM26254 | SDUM 40XD5 WCM.06T308 | ✓ | 40 | 32 | 44 | 281 | 200 | 220 | 60 | 308 € | | |

| Size Designation | Master Insert* | Spare Parts | | |
|------------------|----------------|------------------|--------------|--------------------|
| | | Screw | Torx Key | Screw Torque Value |
| | | | | |
| D16 - D23 | WCM. 030208 | SSV M2.5x6-9505 | STK-T08-9908 | 1,2 |
| | WCM. 040208 | | | |
| D24 - D29 | WCM. 050308 | SSV M3x8-9508 | | 1,9 |
| D30 - D40 | WCM. 06T308 | SSV M3.5x10-9511 | STK-T15-9910 | 2,9 |

U-Drills

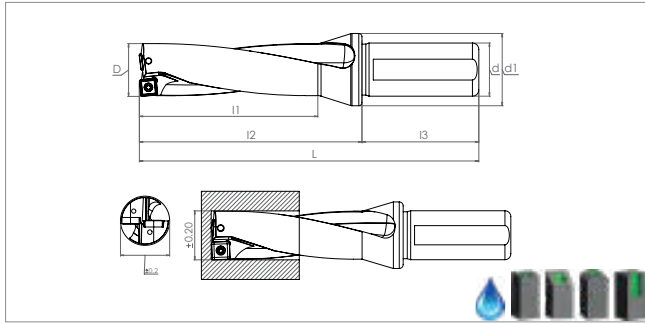

| Ordering Code | Item Designation | POWER SERIES | Dimensions (mm) | | | | | | | Price | Master Insert* | |
|---------------|---|--------------|-----------------|----|----|-----|----|----|----|-------|----------------|--|
| | | | D | d | d1 | L | l1 | l2 | l3 | | | |
| | SDUM Dx2 - SPMG 050204 / 060204 / 07T308 U-DRILL | | | | | | | | | | <i>EURO</i> | |
| SM19294 | SDUM 12.5XD2 SPMG 050204 | ✓ | 12.5 | 20 | 25 | 94 | 25 | 44 | 50 | 131 € | SPMG 050204 | |
| SM19232 | SDUM 13XD2 SPMG 050204 | ✓ | 13 | 20 | 25 | 94 | 26 | 44 | 50 | 131 € | | |
| SM19249 | SDUM 13.5XD2 SPMG 050204 | ✓ | 13.5 | 20 | 25 | 96 | 27 | 46 | 50 | 131 € | | |
| SM19256 | SDUM 14XD2 SPMG 050204 | ✓ | 14 | 20 | 25 | 96 | 28 | 46 | 50 | 131 € | | |
| SM19263 | SDUM 14.5XD2 SPMG 050204 | ✓ | 14.5 | 20 | 25 | 99 | 29 | 49 | 50 | 131 € | | |
| SM19270 | SDUM 15XD2 SPMG 050204 | ✓ | 15 | 20 | 25 | 99 | 30 | 49 | 50 | 131 € | | |
| SM19287 | SDUM 15.5XD2 SPMG 060204 | ✓ | 15.5 | 20 | 25 | 102 | 31 | 52 | 50 | 131 € | SPMG 060204 | |
| SM18082 | SDUM 16XD2 SPMG 060204 | ✓ | 16 | 25 | 34 | 108 | 32 | 52 | 56 | 131 € | | |
| SM18099 | SDUM 16.5XD2 SPMG 060204 | ✓ | 16.5 | 25 | 34 | 110 | 33 | 54 | 56 | 131 € | | |
| SM18105 | SDUM 17XD2 SPMG 060204 | ✓ | 17 | 25 | 34 | 110 | 34 | 54 | 56 | 131 € | | |
| SM18112 | SDUM 17.5XD2 SPMG 060204 | ✓ | 17.5 | 25 | 34 | 113 | 35 | 57 | 56 | 131 € | | |
| SM18129 | SDUM 18XD2 SPMG 060204 | ✓ | 18 | 25 | 34 | 113 | 36 | 57 | 56 | 131 € | | |
| SM18136 | SDUM 18.5XD2 SPMG 060204 | ✓ | 18.5 | 25 | 34 | 115 | 37 | 59 | 56 | 131 € | | |
| SM18143 | SDUM 19XD2 SPMG 060204 | ✓ | 19 | 25 | 34 | 115 | 38 | 59 | 56 | 131 € | | |
| SM18150 | SDUM 19.5XD2 SPMG 060204 | ✓ | 19.5 | 25 | 34 | 119 | 39 | 63 | 56 | 131 € | | |
| SM18501 | SDUM 20XD2 SPMG 060204 | ✓ | 20 | 25 | 34 | 119 | 40 | 63 | 56 | 131 € | | |
| SM19300 | SDUM 20.5XD2 SPMG 060204 | ✓ | 20.5 | 25 | 34 | 121 | 41 | 65 | 56 | 131 € | | |
| SM18518 | SDUM 21XD2 SPMG 060204 | ✓ | 21 | 25 | 34 | 121 | 42 | 65 | 56 | 131 € | | |
| SM19317 | SDUM 21.5XD2 SPMG 060204 | ✓ | 21.5 | 25 | 34 | 123 | 43 | 67 | 56 | 131 € | | |
| SM18525 | SDUM 22XD2 SPMG 07T308 | ✓ | 22 | 25 | 34 | 123 | 44 | 67 | 56 | 131 € | SPMG 07T308 | |
| SM19324 | SDUM 22.5XD2 SPMG 07T308 | ✓ | 22.5 | 25 | 34 | 127 | 45 | 71 | 56 | 131 € | | |
| SM18532 | SDUM 23XD2 SPMG 07T308 | ✓ | 23 | 25 | 34 | 127 | 46 | 71 | 56 | 131 € | | |
| SM19331 | SDUM 23.5XD2 SPMG 07T308 | ✓ | 23.5 | 25 | 34 | 130 | 47 | 74 | 56 | 131 € | | |
| SM18549 | SDUM 24XD2 SPMG 07T308 | ✓ | 24 | 25 | 44 | 130 | 48 | 74 | 56 | 131 € | | |
| SM18488 | SDUM 24.5XD2 SPMG 07T308 | ✓ | 24.5 | 25 | 44 | 133 | 49 | 77 | 56 | 131 € | | |
| SM18556 | SDUM 25XD2 SPMG 07T308 | ✓ | 25 | 25 | 44 | 133 | 50 | 77 | 56 | 131 € | | |
| SM19461 | SDUM 25.5XD2 SPMG 07T308 | ✓ | 25.5 | 25 | 44 | 135 | 51 | 79 | 56 | 140 € | | |
| SM18570 | SDUM 26XD2 SPMG 07T308 | ✓ | 26 | 25 | 44 | 135 | 52 | 79 | 56 | 140 € | | |
| SM19591 | SDUM 26.5XD2 SPMG 07T308 | ✓ | 26.5 | 25 | 44 | 137 | 53 | 81 | 56 | 140 € | | |
| SM18563 | SDUM 27XD2 SPMG 07T308 | ✓ | 27 | 25 | 44 | 137 | 54 | 81 | 56 | 140 € | | |
| SM19607 | SDUM 27.5XD2 SPMG 07T308 | ✓ | 27.5 | 25 | 44 | 140 | 55 | 84 | 56 | 140 € | | |

| Size Designation | Master Insert* | Spare Parts | | |
|------------------|----------------|-----------------|--------------|--------------------|
| | | Screw | Torx Key | Screw Torque Value |
| D12.5 - D15 | SPMG 050204 | SSV M2x5-9502 | STK-T06-9906 | 0,6 |
| D15.5 - D21.5 | SPMG 060204 | SSV M2.2x5-9503 | | 0,85 |
| D22 - D27.5 | SPMG 07T308 | SSV M2.5x7-9506 | STK-T08-9908 | 1,2 |

Continued on next page
Devami sonraki sayfada

*Suitable Insert brand is TGTC

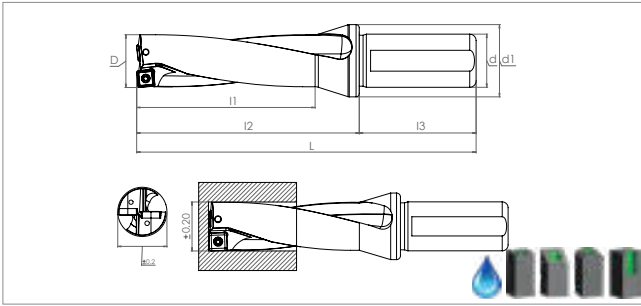
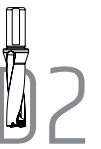

| Ordering Code | Item Designation | POWER SERIES | Dimensions (mm) | | | | | | | Price | Master Insert* | | |
|---------------|---|--------------|-----------------|----|----|-----|-----|-----|----|-------|----------------|------|--|
| | | | D | d | d1 | L | l1 | l2 | l3 | | | EURO | |
| | SDUM Dx2 - SPMG 090408 / 110408 / 140512 U-DRILL | | | | | | | | | | | | |
| SM18587 | SDUM 28XD2 SPMG 090408 | ✓ | 28 | 25 | 44 | 140 | 56 | 84 | 56 | 140 € | SPMG 090408 | | |
| SM19614 | SDUM 28.5XD2 SPMG 090408 | ✓ | 28.5 | 25 | 44 | 142 | 57 | 86 | 56 | 140 € | | | |
| SM18594 | SDUM 29XD2 SPMG 090408 | ✓ | 29 | 25 | 44 | 142 | 58 | 86 | 56 | 140 € | | | |
| SM18600 | SDUM 29.5XD2 SPMG 090408 | ✓ | 29.5 | 25 | 44 | 151 | 59 | 91 | 56 | 140 € | | | |
| SM18785 | SDUM 30XD2 SPMG 090408 | ✓ | 30 | 32 | 44 | 141 | 60 | 81 | 60 | 150 € | | | |
| SM18792 | SDUM 31XD2 SPMG 090408 | ✓ | 31 | 32 | 44 | 144 | 62 | 83 | 60 | 150 € | | | |
| SM18808 | SDUM 32XD2 SPMG 090408 | ✓ | 32 | 32 | 44 | 146 | 64 | 86 | 60 | 150 € | | | |
| SM18815 | SDUM 33XD2 SPMG 090408 | ✓ | 33 | 32 | 44 | 149 | 66 | 88 | 60 | 150 € | | | |
| SM18716 | SDUM 34XD2 SPMG 110408 | ✓ | 34 | 32 | 44 | 151 | 68 | 91 | 60 | 150 € | SPMG 110408 | | |
| SM18723 | SDUM 35XD2 SPMG 110408 | ✓ | 35 | 32 | 44 | 154 | 70 | 93 | 60 | 150 € | | | |
| SM18730 | SDUM 36XD2 SPMG 110408 | ✓ | 36 | 32 | 44 | 157 | 72 | 96 | 60 | 150 € | | | |
| SM18747 | SDUM 37XD2 SPMG 110408 | ✓ | 37 | 32 | 44 | 160 | 74 | 100 | 60 | 150 € | | | |
| SM18754 | SDUM 38XD2 SPMG 110408 | ✓ | 38 | 32 | 44 | 163 | 76 | 103 | 60 | 150 € | | | |
| SM18761 | SDUM 39XD2 SPMG 110408 | ✓ | 39 | 32 | 44 | 165 | 78 | 105 | 60 | 150 € | | | |
| SM18778 | SDUM 40XD2 SPMG 110408 | ✓ | 40 | 32 | 44 | 168 | 80 | 108 | 60 | 150 € | | | |
| SM19058 | SDUM 41XD2 SPMG 110408 | ✓ | 41 | 32 | 44 | 171 | 82 | 110 | 60 | 158 € | | | |
| SM19065 | SDUM 42XD2 SPMG 140512 | ✓ | 42 | 32 | 44 | 173 | 84 | 112 | 60 | 158 € | SPMG 140512 | | |
| SM19089 | SDUM 43XD2 SPMG 140512 | ✓ | 43 | 32 | 44 | 176 | 86 | 114 | 60 | 158 € | | | |
| SM19072 | SDUM 44XD2 SPMG 140512 | ✓ | 44 | 32 | 44 | 178 | 88 | 117 | 60 | 158 € | | | |
| SM19621 | SDUM 45XD2 SPMG 140512 | ✓ | 45 | 40 | 60 | 192 | 90 | 123 | 70 | 164 € | | | |
| SM19638 | SDUM 46XD2 SPMG 140512 | ✓ | 46 | 40 | 60 | 195 | 92 | 125 | 70 | 175 € | | | |
| SM19645 | SDUM 47XD2 SPMG 140512 | ✓ | 47 | 40 | 60 | 197 | 94 | 127 | 70 | 176 € | | | |
| SM19652 | SDUM 48XD2 SPMG 140512 | ✓ | 48 | 40 | 60 | 200 | 96 | 130 | 70 | 185 € | | | |
| SM19683 | SDUM 49XD2 SPMG 140512 | ✓ | 49 | 40 | 60 | 202 | 98 | 132 | 70 | 193 € | | | |
| SM19690 | SDUM 50XD2 SPMG 140512 | ✓ | 50 | 40 | 60 | 205 | 100 | 135 | 70 | 204 € | | | |

| Size Designation | Master Insert* | Spare Parts | | |
|------------------|----------------|------------------|--------------|--------------------|
| | | Screw | Torx Key | Screw Torque Value |
| D28 - D33 | | SSV M3.5x10-9511 | STK-T15-9910 | 2,9 |
| D34 - D41 | | SSV M4x10-9514 | STK-T20-9911 | 4,3 |
| D42 - D50 | | SSV M5x13-9519 | STK-T20-9911 | 8,5 |

U-Drills

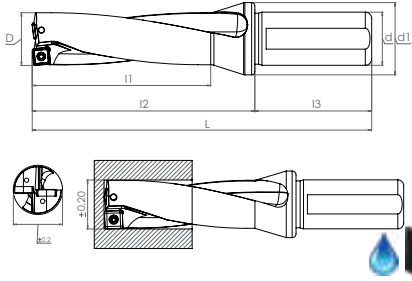

| Ordering Code | Item Designation | POWER SERIES | Dimensions (mm) | | | | | | | Price | Master Insert* | |
|---------------|---|--------------|-----------------|----|----|-----|------|-----|----|-------|----------------|--|
| | | | D | d | d1 | L | l1 | l2 | l3 | | | |
| | SDUM Dx3 - SPMG 050204 / 060204 / 07T308 U-DRILL | | | | | | | | | | EURO | |
| SM18846 | SDUM 12.5XD3 SPMG 050204 | ✓ | 12.5 | 20 | 25 | 107 | 37 | 57 | 50 | 140 € | SPMG 050204 | |
| SM18853 | SDUM 13XD3 SPMG 050204 | ✓ | 13 | 20 | 25 | 107 | 39 | 57 | 50 | 140 € | | |
| SM18860 | SDUM 13.5XD3 SPMG 050204 | ✓ | 13.5 | 20 | 25 | 110 | 40.5 | 60 | 50 | 140 € | | |
| SM18877 | SDUM 14XD3 SPMG 050204 | ✓ | 14 | 20 | 25 | 110 | 42 | 60 | 50 | 140 € | | |
| SM18884 | SDUM 14.5XD3 SPMG 050204 | ✓ | 14.5 | 20 | 25 | 113 | 43.5 | 63 | 50 | 140 € | | |
| SM18891 | SDUM 15XD3 SPMG 050204 | ✓ | 15 | 20 | 25 | 113 | 45 | 63 | 50 | 140 € | | |
| SM18907 | SDUM 15.5XD3 SPMG 060204 | ✓ | 15.5 | 20 | 25 | 118 | 46.5 | 68 | 50 | 140 € | SPMG 060204 | |
| SM18013 | SDUM 16XD3 SPMG 060204 | ✓ | 16 | 25 | 34 | 124 | 48 | 68 | 56 | 140 € | | |
| SM18167 | SDUM 16.5XD3 SPMG 060204 | ✓ | 16.5 | 25 | 34 | 127 | 49.5 | 71 | 56 | 140 € | | |
| SM18020 | SDUM 17XD3 SPMG 060204 | ✓ | 17 | 25 | 34 | 127 | 51 | 71 | 56 | 140 € | | |
| SM18174 | SDUM 17.5XD3 SPMG 060204 | ✓ | 17.5 | 25 | 34 | 131 | 52.5 | 75 | 56 | 140 € | | |
| SM18037 | SDUM 18XD3 SPMG 060204 | ✓ | 18 | 25 | 34 | 131 | 54 | 75 | 56 | 140 € | | |
| SM18181 | SDUM 18.5XD3 SPMG 060204 | ✓ | 18.5 | 25 | 34 | 134 | 55.5 | 78 | 56 | 140 € | | |
| SM18044 | SDUM 19XD3 SPMG 060204 | ✓ | 19 | 25 | 34 | 134 | 57 | 78 | 56 | 140 € | | |
| SM18198 | SDUM 19.5XD3 SPMG 060204 | ✓ | 19.5 | 25 | 34 | 139 | 58.5 | 83 | 56 | 140 € | | |
| SM18617 | SDUM 20XD3 SPMG 060204 | ✓ | 20 | 25 | 34 | 139 | 60 | 83 | 56 | 144 € | | |
| SM18921 | SDUM 20.5XD3 SPMG 060204 | ✓ | 20.5 | 25 | 34 | 142 | 61.5 | 88 | 56 | 144 € | SPMG 07T308 | |
| SM18624 | SDUM 21XD3 SPMG 060204 | ✓ | 21 | 25 | 34 | 142 | 63 | 88 | 56 | 144 € | | |
| SM18914 | SDUM 21.5XD3 SPMG 060204 | ✓ | 21.5 | 25 | 34 | 145 | 64.5 | 89 | 56 | 144 € | | |
| SM18655 | SDUM 22XD3 SPMG 07T308 | ✓ | 22 | 25 | 34 | 145 | 66 | 89 | 56 | 144 € | | |
| SM18945 | SDUM 22.5XD3 SPMG 07T308 | ✓ | 22.5 | 25 | 34 | 150 | 67.5 | 94 | 56 | 144 € | | |
| SM18648 | SDUM 23XD3 SPMG 07T308 | ✓ | 23 | 25 | 34 | 150 | 69 | 94 | 56 | 144 € | | |
| SM18938 | SDUM 23.5XD3 SPMG 07T308 | ✓ | 23.5 | 25 | 34 | 154 | 70.5 | 98 | 56 | 144 € | | |
| SM18631 | SDUM 24XD3 SPMG 07T308 | ✓ | 24 | 25 | 34 | 154 | 72 | 98 | 56 | 144 € | | |
| SM18495 | SDUM 24.5XD3 SPMG 07T308 | ✓ | 24.5 | 25 | 34 | 158 | 73.5 | 102 | 56 | 144 € | | |
| SM18662 | SDUM 25XD3 SPMG 07T308 | ✓ | 25 | 25 | 34 | 158 | 75 | 102 | 56 | 150 € | | |
| SM18051 | SDUM 25.5XD3 SPMG 07T308 | ✓ | 25.5 | 25 | 34 | 161 | 76.5 | 105 | 56 | 150 € | | |
| SM18686 | SDUM 26XD3 SPMG 07T308 | ✓ | 26 | 25 | 34 | 161 | 78 | 105 | 56 | 150 € | | |
| SM18068 | SDUM 26.5XD3 SPMG 07T308 | ✓ | 26.5 | 25 | 34 | 164 | 79.5 | 108 | 56 | 150 € | | |
| SM18679 | SDUM 27XD3 SPMG 07T308 | ✓ | 27 | 25 | 34 | 164 | 81 | 108 | 56 | 150 € | | |
| SM18075 | SDUM 27.5XD3 SPMG 07T308 | ✓ | 27.5 | 25 | 34 | 168 | 82.5 | 112 | 56 | 150 € | | |

| Size Designation | Master Insert* | Spare Parts | | |
|------------------|----------------|-----------------|--------------|--------------------|
| | | Screw | Torx Key | Screw Torque Value |
| D12.5 - D15 | | SSV M2x5-9502 | STK-T06-9906 | N-m 0,6 |
| D15.5 - D21.5 | | SSV M2.2x5-9503 | STK-T06-9906 | N-m 0,85 |
| D22 - D27.5 | | SSV M2.5x7-9506 | STK-T08-9908 | N-m 1,2 |

Continued on next page
Devami sonraki sayfada

*Suitable Insert brand is TGTC

2022 PRICE LIST

J: 271 // 302

U-Drills

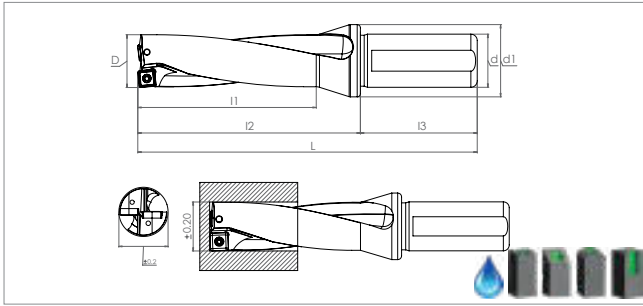

| Ordering Code | Item Designation | POWER SERIES | Dimensions (mm) | | | | | | | Price | Master Insert* | | |
|---------------|---|--------------|-----------------|----|----|-----|------|-----|----|-------|----------------|------|-------------|
| | | | D | d | d1 | L | l1 | l2 | l3 | | | EURO | |
| | SDUM Dx3 - SPMG 090408 / 110408 / 140512 U-DRILL | | | | | | | | | | | | |
| SM18709 | SDUM 28XD3 SPMG 090408 | ✓ | 28 | 25 | 34 | 168 | 84 | 112 | 56 | 150 € | SPMG 090408 | | |
| SM18822 | SDUM 28.5XD3 SPMG 090408 | ✓ | 28.5 | 25 | 34 | 171 | 85.5 | 115 | 56 | 150 € | | | |
| SM18693 | SDUM 29XD3 SPMG 090408 | ✓ | 29 | 25 | 34 | 171 | 87 | 115 | 56 | 150 € | | | |
| SM18839 | SDUM 29.5XD3 SPMG 090408 | ✓ | 29.5 | 25 | 34 | 177 | 88.5 | 111 | 56 | 150 € | | | |
| SM19041 | SDUM 30XD3 SPMG 090408 | ✓ | 30 | 32 | 44 | 171 | 90 | 111 | 60 | 155 € | | | |
| SM19133 | SDUM 31XD3 SPMG 090408 | ✓ | 31 | 32 | 44 | 175 | 93 | 115 | 60 | 155 € | | | |
| SM19027 | SDUM 32XD3 SPMG 090408 | ✓ | 32 | 32 | 44 | 178 | 96 | 118 | 60 | 155 € | | | |
| SM19034 | SDUM 33XD3 SPMG 090408 | ✓ | 33 | 32 | 44 | 182 | 99 | 122 | 60 | 155 € | | | |
| SM18952 | SDUM 34XD3 SPMG 110408 | ✓ | 34 | 32 | 44 | 185 | 102 | 125 | 60 | 155 € | | | SPMG 110408 |
| SM18969 | SDUM 35XD3 SPMG 110408 | ✓ | 35 | 32 | 44 | 189 | 105 | 129 | 60 | 155 € | | | |
| SM18976 | SDUM 36XD3 SPMG 110408 | ✓ | 36 | 32 | 44 | 193 | 108 | 133 | 60 | 155 € | | | |
| SM18983 | SDUM 37XD3 SPMG 110408 | ✓ | 37 | 32 | 44 | 197 | 111 | 136 | 60 | 155 € | | | |
| SM18990 | SDUM 38XD3 SPMG 110408 | ✓ | 38 | 32 | 44 | 201 | 114 | 141 | 60 | 155 € | | | |
| SM19003 | SDUM 39XD3 SPMG 110408 | ✓ | 39 | 32 | 44 | 204 | 117 | 144 | 60 | 155 € | | | |
| SM19010 | SDUM 40XD3 SPMG 110408 | ✓ | 40 | 32 | 44 | 208 | 120 | 148 | 60 | 155 € | | | |
| SM19096 | SDUM 41XD3 SPMG 110408 | ✓ | 41 | 32 | 44 | 212 | 123 | 152 | 60 | 171 € | | | |
| SM19102 | SDUM 42XD3 SPMG 140512 | ✓ | 42 | 32 | 44 | 215 | 126 | 155 | 60 | 171 € | SPMG 140512 | | |
| SM19140 | SDUM 43XD3 SPMG 140512 | ✓ | 43 | 32 | 44 | 219 | 129 | 158 | 60 | 171 € | | | |
| SM19157 | SDUM 44XD3 SPMG 140512 | ✓ | 44 | 32 | 44 | 222 | 132 | 162 | 60 | 171 € | | | |
| SM19164 | SDUM 45XD3 SPMG 140512 | ✓ | 45 | 40 | 60 | 237 | 135 | 167 | 70 | 171 € | | | |
| SM19171 | SDUM 46XD3 SPMG 140512 | ✓ | 46 | 40 | 60 | 241 | 138 | 171 | 70 | 176 € | | | |
| SM19188 | SDUM 47XD3 SPMG 140512 | ✓ | 47 | 40 | 60 | 244 | 141 | 174 | 70 | 185 € | | | |
| SM19195 | SDUM 48XD3 SPMG 140512 | ✓ | 48 | 40 | 60 | 248 | 144 | 178 | 70 | 193 € | | | |
| SM19201 | SDUM 49XD3 SPMG 140512 | ✓ | 49 | 40 | 60 | 251 | 147 | 181 | 70 | 199 € | | | |
| SM19218 | SDUM 50XD3 SPMG 140512 | ✓ | 50 | 40 | 60 | 255 | 150 | 185 | 70 | 207 € | | | |
| SM19225 | SDUM 51XD3 SPMG 140512 | ✓ | 51 | 40 | 60 | 258 | 153 | 188 | 70 | 220 € | | | |
| SM19454 | SDUM 52XD3 SPMG 140512 | ✓ | 52 | 40 | 60 | 261 | 156 | 191 | 70 | 225 € | | | |
| SM19355 | SDUM 53XD3 SPMG 140512 | ✓ | 53 | 40 | 60 | 264 | 159 | 194 | 70 | 233 € | | | |
| SM19386 | SDUM 54XD3 SPMG 140512 | ✓ | 54 | 40 | 60 | 267 | 162 | 197 | 70 | 254 € | | | |

| Size Designation | Master Insert* | Spare Parts | | |
|------------------|----------------|------------------|--------------|--------------------|
| | | Screw | Torx Key | Screw Torque Value |
| D28 - D33 | SPMG 090408 | SSV M3.5x10-9511 | STK-T15-9910 | 2,9 |
| D34 - D41 | SPMG 110408 | SSV M4x10-9514 | | 4,3 |
| D42 - D54 | SPMG 140512 | SSV M5x13-9519 | STK-T20-9911 | 8,5 |

U-Drills

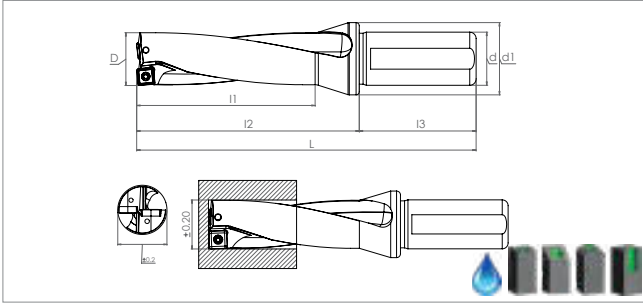

| Ordering Code | Item Designation | POWER SERIES | Dimensions (mm) | | | | | | | Price | Master Insert* | |
|---------------|---|--------------|-----------------|----|----|-----|-----|-----|----|-------|----------------|--|
| | | | D | d | d1 | L | l1 | l2 | l3 | | | |
| | SDUM Dx4 - SPMG 050204 / 060204 / 07T308 U-DRILL | | | | | | | | | | EURO | |
| SM25370 | SDUM 12.5XD4 SPMG 050204 | ✓ | 12.5 | 20 | 25 | 120 | 52 | 70 | 50 | 175 € | SPMG 050204 | |
| SM18204 | SDUM 13XD4 SPMG 050204 | ✓ | 13 | 20 | 25 | 120 | 52 | 70 | 50 | 175 € | | |
| SM19744 | SDUM 13.5XD4 SPMG 050204 | ✓ | 13.5 | 20 | 25 | 120 | 52 | 70 | 50 | 175 € | | |
| SM18211 | SDUM 14XD4 SPMG 050204 | ✓ | 14 | 20 | 25 | 124 | 56 | 73 | 50 | 175 € | | |
| SM19751 | SDUM 14.5XD4 SPMG 050204 | ✓ | 14.5 | 20 | 25 | 124 | 56 | 78 | 50 | 175 € | | |
| SM18228 | SDUM 15XD4 SPMG 050204 | ✓ | 15 | 20 | 25 | 128 | 60 | 78 | 50 | 175 € | | |
| SM19768 | SDUM 15.5XD4 SPMG 060204 | ✓ | 15.5 | 20 | 25 | 128 | 60 | 85 | 50 | 175 € | SPMG 060204 | |
| SM18235 | SDUM 16XD4 SPMG 060204 | ✓ | 16 | 25 | 34 | 140 | 64 | 84 | 56 | 177 € | | |
| SM19720 | SDUM 16.5XD4 SPMG 060204 | ✓ | 16.5 | 25 | 34 | 144 | 66 | 84 | 56 | 177 € | | |
| SM18242 | SDUM 17XD4 SPMG 060204 | ✓ | 17 | 25 | 34 | 144 | 68 | 88 | 56 | 177 € | | |
| SM19775 | SDUM 17.5XD4 SPMG 060204 | ✓ | 17.5 | 25 | 34 | 149 | 70 | 88 | 56 | 177 € | | |
| SM18259 | SDUM 18XD4 SPMG 060204 | ✓ | 18 | 25 | 34 | 149 | 72 | 93 | 56 | 177 € | | |
| SM19782 | SDUM 18.5XD4 SPMG 060204 | ✓ | 18.5 | 25 | 34 | 153 | 74 | 93 | 56 | 177 € | | |
| SM18266 | SDUM 19XD4 SPMG 060204 | ✓ | 19 | 25 | 34 | 153 | 76 | 97 | 56 | 177 € | | |
| SM19799 | SDUM 19.5XD4 SPMG 060204 | ✓ | 19.5 | 25 | 34 | 159 | 78 | 97 | 56 | 177 € | | |
| SM18273 | SDUM 20XD4 SPMG 060204 | ✓ | 20 | 25 | 34 | 159 | 80 | 103 | 56 | 177 € | | |
| SM19805 | SDUM 20.5XD4 SPMG 060204 | ✓ | 20.5 | 25 | 34 | 163 | 82 | 103 | 56 | 177 € | SPMG 07T308 | |
| SM18280 | SDUM 21XD4 SPMG 060204 | ✓ | 21 | 25 | 34 | 163 | 84 | 107 | 56 | 185 € | | |
| SM19812 | SDUM 21.5XD4 SPMG 060204 | ✓ | 21.5 | 25 | 34 | 167 | 86 | 107 | 56 | 185 € | | |
| SM18297 | SDUM 22XD4 SPMG 07T308 | ✓ | 22 | 25 | 34 | 167 | 88 | 111 | 56 | 185 € | | |
| SM19829 | SDUM 22.5XD4 SPMG 07T308 | ✓ | 22.5 | 25 | 34 | 173 | 90 | 111 | 56 | 185 € | | |
| SM18303 | SDUM 23XD4 SPMG 07T308 | ✓ | 23 | 25 | 34 | 173 | 92 | 117 | 56 | 185 € | | |
| SM19836 | SDUM 23.5XD4 SPMG 07T308 | ✓ | 23.5 | 25 | 34 | 178 | 94 | 117 | 56 | 185 € | | |
| SM18310 | SDUM 24XD4 SPMG 07T308 | ✓ | 24 | 25 | 34 | 178 | 96 | 122 | 56 | 185 € | | |
| SM19843 | SDUM 24.5XD4 SPMG 07T308 | ✓ | 24.5 | 25 | 34 | 183 | 98 | 122 | 56 | 185 € | | |
| SM18327 | SDUM 25XD4 SPMG 07T308 | ✓ | 25 | 25 | 34 | 183 | 100 | 127 | 56 | 185 € | | |
| SM19737 | SDUM 25.5XD4 SPMG 07T308 | ✓ | 25.5 | 25 | 34 | 187 | 102 | 127 | 56 | 185 € | SPMG 07T308 | |
| SM18334 | SDUM 26XD4 SPMG 07T308 | ✓ | 26 | 25 | 34 | 187 | 104 | 131 | 56 | 206 € | | |
| SM19850 | SDUM 26.5XD4 SPMG 07T308 | ✓ | 26.5 | 25 | 34 | 191 | 106 | 131 | 56 | 206 € | | |
| SM18341 | SDUM 27XD4 SPMG 07T308 | ✓ | 27 | 25 | 34 | 191 | 108 | 135 | 56 | 206 € | | |
| SM19867 | SDUM 27.5XD4 SPMG 07T308 | ✓ | 27.5 | 25 | 34 | 196 | 110 | 135 | 56 | 206 € | | |

| Size Designation | Master Insert* | Spare Parts | | |
|------------------|----------------|-----------------|--------------|--------------------|
| | | Screw | Torx Key | Screw Torque Value |
| D12.5 - D15 | | SSV M2x5-9502 | | N-m |
| D15.5 - D21.5 | SPMG 060204 | SSV M2.2x5-9503 | STK-T06-9906 | 0,6 |
| D22 - D27.5 | SPMG 07T308 | SSV M2.5x7-9506 | STK-T08-9908 | 0,85 |
| | | | | 1,2 |

Continued on next page
Devami sonraki sayfada

*Suitable Insert brand is TGTC

2022 PRICE LIST

J: 273 // 302

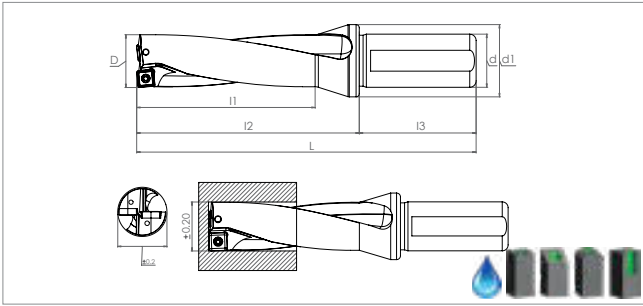

| Ordering Code | Item Designation | POWER SERIES | Dimensions (mm) | | | | | | | Price | Master Insert* | |
|---------------|---|--------------|-----------------|----|----|-----|-----|-----|----|-------|----------------|--|
| | | | D | d | d1 | L | l1 | l2 | l3 | | | |
| | SDUM Dx4 - SPMG 090408 / 110408 / 140512 U-DRILL | | | | | | | | | | EURO | |
| SM18358 | SDUM 28XD4 SPMG 090408 | ✓ | 28 | 25 | 34 | 196 | 112 | 140 | 56 | 206 € | SPMG 090408 | |
| SM19874 | SDUM 28.5XD4 SPMG 090408 | ✓ | 28.5 | 25 | 34 | 200 | 114 | 140 | 56 | 206 € | | |
| SM18372 | SDUM 29XD4 SPMG 090408 | ✓ | 29 | 25 | 34 | 200 | 116 | 144 | 56 | 206 € | | |
| SM19881 | SDUM 29.5XD4 SPMG 090408 | ✓ | 29.5 | 25 | 34 | 202 | 118 | 144 | 56 | 206 € | | |
| SM18365 | SDUM 30XD4 SPMG 090408 | ✓ | 30 | 32 | 44 | 201 | 120 | 141 | 60 | 220 € | | |
| SM18389 | SDUM 31XD4 SPMG 090408 | ✓ | 31 | 32 | 44 | 206 | 124 | 145 | 60 | 220 € | | |
| SM18396 | SDUM 32XD4 SPMG 090408 | ✓ | 32 | 32 | 44 | 210 | 128 | 149 | 60 | 220 € | | |
| SM18402 | SDUM 33XD4 SPMG 090408 | ✓ | 33 | 32 | 44 | 215 | 132 | 154 | 60 | 220 € | | |
| SM25417 | SDUM 33.5XD4 SPMG 090408 | ✓ | 33.5 | 32 | 44 | 219 | 134 | 158 | 60 | 220 € | | |
| SM18419 | SDUM 34XD4 SPMG 110408 | ✓ | 34 | 32 | 44 | 219 | 136 | 158 | 60 | 220 € | | |
| SM18426 | SDUM 35XD4 SPMG 110408 | ✓ | 35 | 32 | 44 | 224 | 140 | 166 | 60 | 220 € | | |
| SM18433 | SDUM 36XD4 SPMG 110408 | ✓ | 36 | 32 | 44 | 229 | 144 | 169 | 60 | 220 € | | |
| SM18440 | SDUM 37XD4 SPMG 110408 | ✓ | 37 | 32 | 44 | 234 | 148 | 172 | 60 | 233 € | | |
| SM18457 | SDUM 38XD4 SPMG 110408 | ✓ | 38 | 32 | 44 | 239 | 152 | 178 | 60 | 233 € | | |
| SM20948 | SDUM 38.5XD4 SPMG 110408 | ✓ | 38.5 | 32 | 44 | 243 | 154 | 181 | 60 | 233 € | | |
| SM18464 | SDUM 39XD4 SPMG 110408 | ✓ | 39 | 32 | 44 | 243 | 156 | 181 | 60 | 233 € | | |
| SM18471 | SDUM 40XD4 SPMG 110408 | ✓ | 40 | 32 | 44 | 248 | 160 | 188 | 60 | 233 € | | |
| SM19119 | SDUM 41XD4 SPMG 110408 | ✓ | 41 | 32 | 44 | 253 | 164 | 191 | 60 | 239 € | | |
| SM19126 | SDUM 42XD4 SPMG 140512 | ✓ | 42 | 32 | 44 | 257 | 168 | 195 | 60 | 239 € | SPMG 140512 | |
| SM19362 | SDUM 43XD4 SPMG 140512 | ✓ | 43 | 32 | 44 | 262 | 172 | 197 | 60 | 239 € | | |
| SM19379 | SDUM 44XD4 SPMG 140512 | ✓ | 44 | 32 | 44 | 266 | 176 | 200 | 60 | 239 € | | |

| Size Designation | Master Insert* | Spare Parts | | |
|------------------|----------------|------------------|--------------|--------------------|
| | | Screw | Torx Key | Screw Torque Value |
| | | | | N·m |
| D28 - D33 | SPMG 090408 | SSV M3.5x10-9511 | STK-T15-9910 | 2,9 |
| D34 - D41 | SPMG 110408 | SSV M4x10-9514 | | 2,9 |
| D42 - D44 | SPMG 140512 | SSV M5x13-9519 | STK-T20-9911 | 8,5 |



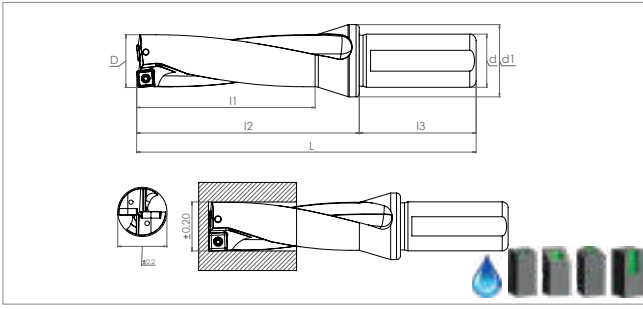

| Ordering Code | Item Designation | POWER SERIES | Dimensions (mm) | | | | | | | Price | Master Insert* | |
|---------------|--|--------------|-----------------|----|----|-----|-----|-----|----|-------|----------------|--|
| | | | D | d | d1 | L | l1 | l2 | l3 | | | |
| | SDUM Dx5 - SPMG 050204 / 060204 / 07T308 / 090408 U-DRILL | | | | | | | | | | EURO | |
| SM19676 | SDUM 13XD5 SPMG 050204 | ✓ | 13 | 20 | 25 | 130 | 65 | 80 | 50 | 177 € | SPMG 050204 | |
| SM19669 | SDUM 14XD5 SPMG 050204 | ✓ | 14 | 20 | 25 | 135 | 70 | 85 | 50 | 177 € | | |
| SM18006 | SDUM 15XD5 SPMG 050204 | ✓ | 15 | 20 | 25 | 140 | 75 | 90 | 50 | 177 € | | |
| SM19348 | SDUM 16XD5 SPMG 060204 | ✓ | 16 | 25 | 34 | 155 | 80 | 100 | 56 | 208 € | SPMG 060204 | |
| SM19478 | SDUM 17XD5 SPMG 060204 | ✓ | 17 | 25 | 34 | 160 | 85 | 105 | 56 | 208 € | | |
| SM19485 | SDUM 18XD5 SPMG 060204 | ✓ | 18 | 25 | 34 | 165 | 90 | 111 | 56 | 208 € | | |
| SM19492 | SDUM 19XD5 SPMG 060204 | ✓ | 19 | 25 | 34 | 170 | 95 | 116 | 56 | 208 € | | |
| SM19508 | SDUM 20XD5 SPMG 060204 | ✓ | 20 | 25 | 34 | 175 | 100 | 120 | 56 | 220 € | | |
| SM19515 | SDUM 21XD5 SPMG 060204 | ✓ | 21 | 25 | 34 | 180 | 105 | 124 | 56 | 220 € | SPMG 07T308 | |
| SM19522 | SDUM 22XD5 SPMG 07T308 | ✓ | 22 | 25 | 34 | 185 | 110 | 129 | 56 | 220 € | | |
| SM19539 | SDUM 23XD5 SPMG 07T308 | ✓ | 23 | 25 | 34 | 190 | 115 | 135 | 56 | 233 € | | |
| SM19546 | SDUM 24XD5 SPMG 07T308 | ✓ | 24 | 25 | 34 | 195 | 120 | 140 | 56 | 233 € | | |
| SM19553 | SDUM 25XD5 SPMG 07T308 | ✓ | 25 | 25 | 34 | 200 | 125 | 144 | 56 | 233 € | | |
| SM19560 | SDUM 26XD5 SPMG 07T308 | ✓ | 26 | 25 | 34 | 205 | 130 | 149 | 56 | 233 € | SPMG 090408 | |
| SM19577 | SDUM 27XD5 SPMG 07T308 | ✓ | 27 | 25 | 34 | 210 | 135 | 155 | 56 | 233 € | | |
| SM19584 | SDUM 28XD5 SPMG 090408 | ✓ | 28 | 25 | 34 | 215 | 140 | 160 | 56 | 246 € | | |
| SM19706 | SDUM 29XD5 SPMG 090408 | ✓ | 29 | 25 | 34 | 220 | 145 | 165 | 56 | 246 € | | |

| Size Designation | Master Insert* | Spare Parts | | |
|------------------|----------------|--------------------------|----------------------|--------------------|
| | | Screw | Torx Key | Screw Torque Value |
| D13 - D15 | | SSV M2x5- 9502 | STK-T06- 9906 | 0,6 |
| D16 - D21 | | SSV M2.2x5- 9503 | STK-T08- 9908 | 0,85 |
| D22 - D27 | | SSV M2.5x7- 9506 | STK-T15- 9910 | 1,2 |
| D28 - D29 | | SSV M3.5x10- 9511 | | 2,9 |



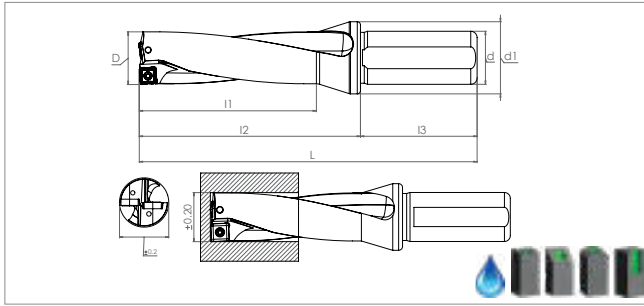
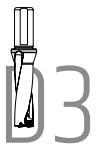

| Ordering Code | Item Designation | Dimensions (mm) | | | | | | | | Price | Master Insert* |
|---------------|---|------------------------|------|----|----|-----|------|-----|----|-------|----------------|
| | SDUM Dx3 - SOMT 050204 / 060204 / 070306 08T206 / 09T308 U-DRILL | POWER SERIES | D | d | d1 | L | l1 | l2 | l3 | EURO | |
| SM42032 | SDUM 14XD3 SOMT 050204 | ✓ | 14 | 20 | 25 | 110 | 42 | 60 | 50 | 144 € | SOMT 050204 |
| SM42049 | SDUM 14.5XD3 SOMT 050204 | ✓ | 14.5 | 20 | 25 | 113 | 43.5 | 63 | 50 | 144 € | |
| SM42056 | SDUM 15XD3 SOMT 050204 | ✓ | 15 | 20 | 25 | 113 | 45 | 63 | 50 | 144 € | |
| SM42063 | SDUM 15.5XD3 SOMT 050204 | ✓ | 15.5 | 20 | 25 | 118 | 46.5 | 68 | 50 | 144 € | |
| SM42070 | SDUM 16XD3 SOMT 050204 | ✓ | 16 | 25 | 34 | 124 | 48 | 68 | 56 | 144 € | |
| SM42087 | SDUM 16.5XD3 SOMT 060204 | ✓ | 16.5 | 25 | 34 | 127 | 49.5 | 71 | 56 | 144 € | SOMT 060204 |
| SM42094 | SDUM 17XD3 SOMT 060204 | ✓ | 17 | 25 | 34 | 127 | 51 | 71 | 56 | 144 € | |
| SM42100 | SDUM 17.5XD3 SOMT 060204 | ✓ | 17.5 | 25 | 34 | 131 | 52.5 | 75 | 56 | 144 € | |
| SM42117 | SDUM 18XD3 SOMT 060204 | ✓ | 18 | 25 | 34 | 131 | 54 | 75 | 56 | 144 € | |
| SM42124 | SDUM 18.5XD3 SOMT 060204 | ✓ | 18.5 | 25 | 34 | 134 | 55.5 | 78 | 56 | 144 € | |
| SM42131 | SDUM 19XD3 SOMT 060204 | ✓ | 19 | 25 | 34 | 134 | 57 | 78 | 56 | 144 € | SOMT 070306 |
| SM42148 | SDUM 19.5XD3 SOMT 070306 | ✓ | 19.5 | 25 | 34 | 139 | 58.5 | 83 | 56 | 144 € | |
| SM42155 | SDUM 20XD3 SOMT 070306 | ✓ | 20 | 25 | 34 | 139 | 60 | 83 | 56 | 148 € | |
| SM42162 | SDUM 20.5XD3 SOMT 070306 | ✓ | 20.5 | 25 | 34 | 142 | 61.5 | 88 | 56 | 148 € | |
| SM42179 | SDUM 21XD3 SOMT 070306 | ✓ | 21 | 25 | 34 | 142 | 63 | 88 | 56 | 148 € | |
| SM42186 | SDUM 21.5XD3 SOMT 070306 | ✓ | 21.5 | 25 | 34 | 145 | 64.5 | 89 | 56 | 148 € | SOMT 08T306 |
| SM42193 | SDUM 22XD3 SOMT 070306 | ✓ | 22 | 25 | 34 | 145 | 66 | 89 | 56 | 148 € | |
| SM42209 | SDUM 22.5XD3 SOMT 08T306 | ✓ | 22.5 | 25 | 34 | 150 | 67.5 | 94 | 56 | 148 € | |
| SM42216 | SDUM 23XD3 SOMT 08T306 | ✓ | 23 | 25 | 34 | 150 | 69 | 94 | 56 | 148 € | |
| SM42223 | SDUM 23.5XD3 SOMT 08T306 | ✓ | 23.5 | 25 | 34 | 154 | 70.5 | 98 | 56 | 148 € | |
| SM42230 | SDUM 24XD3 SOMT 08T306 | ✓ | 24 | 25 | 34 | 154 | 72 | 98 | 56 | 148 € | SOMT 09T308 |
| SM42247 | SDUM 24.5XD3 SOMT 08T306 | ✓ | 24.5 | 25 | 34 | 158 | 73.5 | 102 | 56 | 148 € | |
| SM42254 | SDUM 25XD3 SOMT 08T306 | ✓ | 25 | 25 | 34 | 158 | 75 | 102 | 56 | 155 € | |
| SM42261 | SDUM 25.5XD3 SOMT 08T306 | ✓ | 25.5 | 25 | 34 | 161 | 76.5 | 105 | 56 | 155 € | |
| SM42278 | SDUM 26XD3 SOMT 08T306 | ✓ | 26 | 25 | 34 | 161 | 78 | 105 | 56 | 155 € | |
| SM42285 | SDUM 26.5XD3 SOMT 09T308 | ✓ | 26.5 | 25 | 34 | 164 | 79.5 | 108 | 56 | 155 € | SOMT 09T308 |
| SM42292 | SDUM 27XD3 SOMT 09T308 | ✓ | 27 | 25 | 34 | 164 | 81 | 108 | 56 | 155 € | |
| SM42308 | SDUM 27.5XD3 SOMT 09T308 | ✓ | 27.5 | 25 | 34 | 168 | 82.5 | 112 | 56 | 155 € | |
| SM42315 | SDUM 28XD3 SOMT 09T308 | ✓ | 28 | 25 | 34 | 168 | 84 | 112 | 56 | 155 € | |
| SM42322 | SDUM 28.5XD3 SOMT 09T308 | ✓ | 28.5 | 25 | 34 | 171 | 85.5 | 115 | 56 | 155 € | |
| SM42339 | SDUM 29XD3 SOMT 09T308 | ✓ | 29 | 25 | 34 | 171 | 87 | 115 | 56 | 155 € | SOMT 09T308 |
| SM42346 | SDUM 29.5XD3 SOMT 09T308 | ✓ | 29.5 | 25 | 34 | 177 | 88.5 | 111 | 56 | 155 € | |
| SM42353 | SDUM 30XD3 SOMT 09T308 | ✓ | 30 | 32 | 44 | 171 | 90 | 111 | 60 | 169 € | |

| Size Designation | Master Insert* | Spare Parts | | |
|------------------|----------------|---------------------|------------------|------------------------|
| | | Screw | Torx Key | Screw Torque Value |
| D14 - D16 | | SSV M2x5-9502 | STK-T06-9906 | 0,6 |
| D16.5 - D19 | | | | 0,85 |
| D19.5 - D22 | | SSV M2.2x5-9503 | STK-T08-9908 | 1,2 |
| D22.5 - D26 | | | | 2,9 |
| D26.5 - D30 | | | | SSV M3.5x8-SC 9513 |

U-Drills

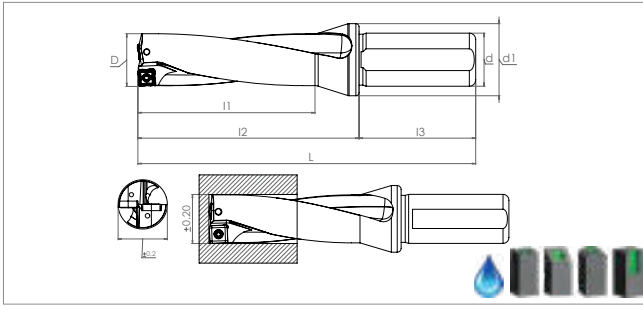

| Ordering Code | Item Designation | POWER SERIES | Dimensions (mm) | | | | | | | Price | Master Insert* | |
|---------------|--|--------------|-----------------|----|----|-----|-----|-----|----|-------|----------------|--|
| | | | D | d | d1 | L | l1 | l2 | l3 | | | |
| | SDUM Dx4 - SOMT 050204 / 060204 / 070306 / 08T306 / 09T308 | | | | | | | | | | EURO | |
| SM42360 | SDUM 14XD4 SOMT 050204 | ✓ | 14 | 20 | 25 | 124 | 56 | 73 | 50 | 183 € | SOMT 050204 | |
| SM42377 | SDUM 15XD4 SOMT 050204 | ✓ | 15 | 20 | 25 | 128 | 60 | 78 | 50 | 183 € | | |
| SM42384 | SDUM 16XD4 SOMT 050204 | ✓ | 16 | 25 | 34 | 140 | 64 | 84 | 56 | 189 € | | |
| SM42391 | SDUM 17XD4 SOMT 060204 | ✓ | 17 | 25 | 34 | 144 | 68 | 88 | 56 | 189 € | SOMT 060204 | |
| SM42407 | SDUM 18XD4 SOMT 060204 | ✓ | 18 | 25 | 34 | 149 | 72 | 93 | 56 | 189 € | | |
| SM42414 | SDUM 19XD4 SOMT 060204 | ✓ | 19 | 25 | 34 | 153 | 76 | 97 | 56 | 189 € | | |
| SM42421 | SDUM 20XD4 SOMT 070306 | ✓ | 20 | 25 | 34 | 159 | 80 | 103 | 56 | 189 € | SOMT 070306 | |
| SM42438 | SDUM 21XD4 SOMT 070306 | ✓ | 21 | 25 | 34 | 163 | 84 | 107 | 56 | 196 € | | |
| SM42445 | SDUM 22XD4 SOMT 070306 | ✓ | 22 | 25 | 34 | 167 | 88 | 111 | 56 | 196 € | | |
| SM42452 | SDUM 23XD4 SOMT 08T306 | ✓ | 23 | 25 | 34 | 173 | 92 | 117 | 56 | 196 € | SOMT 08T306 | |
| SM42469 | SDUM 24XD4 SOMT 08T306 | ✓ | 24 | 25 | 34 | 178 | 96 | 122 | 56 | 196 € | | |
| SM42476 | SDUM 25XD4 SOMT 08T306 | ✓ | 25 | 25 | 34 | 183 | 100 | 127 | 56 | 196 € | | |
| SM42483 | SDUM 26XD4 SOMT 08T306 | ✓ | 26 | 25 | 34 | 187 | 104 | 131 | 56 | 213 € | SOMT 09T308 | |
| SM42490 | SDUM 27XD4 SOMT 09T308 | ✓ | 27 | 25 | 34 | 191 | 108 | 135 | 56 | 213 € | | |
| SM42506 | SDUM 28XD4 SOMT 09T308 | ✓ | 28 | 25 | 34 | 196 | 112 | 140 | 56 | 213 € | | |
| SM42513 | SDUM 29XD4 SOMT 09T308 | ✓ | 29 | 25 | 34 | 200 | 116 | 144 | 56 | 213 € | SOMT 09T308 | |
| SM42520 | SDUM 30XD4 SOMT 09T308 | ✓ | 30 | 32 | 44 | 201 | 120 | 141 | 60 | 223 € | | |

| Ordering Code | Item Designation | POWER SERIES | Dimensions (mm) | | | | | | | Price | Master Insert* | |
|---------------|--|--------------|-----------------|----|----|-----|-----|-----|----|-------|----------------|--|
| | | | D | d | d1 | L | l1 | l2 | l3 | | | |
| | SDUM Dx5 - SOMT 050204 / 060204 / 070306 / 08T306 / 09T308 | | | | | | | | | | EURO | |
| SM42537 | SDUM 14XD5 SOMT 050204 | ✓ | 14 | 20 | 25 | 135 | 70 | 85 | 50 | 193 € | SOMT 050204 | |
| SM42544 | SDUM 15XD5 SOMT 050204 | ✓ | 15 | 20 | 25 | 140 | 75 | 90 | 50 | 193 € | | |
| SM42551 | SDUM 16XD5 SOMT 050204 | ✓ | 16 | 25 | 34 | 155 | 80 | 100 | 56 | 216 € | | |
| SM42568 | SDUM 17XD5 SOMT 060204 | ✓ | 17 | 25 | 34 | 160 | 85 | 105 | 56 | 216 € | SOMT 060204 | |
| SM42575 | SDUM 18XD5 SOMT 060204 | ✓ | 18 | 25 | 34 | 165 | 90 | 111 | 56 | 216 € | | |
| SM42582 | SDUM 19XD5 SOMT 060204 | ✓ | 19 | 25 | 34 | 170 | 95 | 116 | 56 | 216 € | | |
| SM42599 | SDUM 20XD5 SOMT 070306 | ✓ | 20 | 25 | 34 | 175 | 100 | 120 | 56 | 226 € | SOMT 070306 | |
| SM42605 | SDUM 21XD5 SOMT 070306 | ✓ | 21 | 25 | 34 | 180 | 105 | 124 | 56 | 226 € | | |
| SM42612 | SDUM 22XD5 SOMT 070306 | ✓ | 22 | 25 | 34 | 185 | 110 | 129 | 56 | 226 € | | |
| SM42629 | SDUM 23XD5 SOMT 08T306 | ✓ | 23 | 25 | 34 | 190 | 115 | 135 | 56 | 239 € | SOMT 08T306 | |
| SM42636 | SDUM 24XD5 SOMT 08T306 | ✓ | 24 | 25 | 34 | 195 | 120 | 140 | 56 | 239 € | | |
| SM42643 | SDUM 25XD5 SOMT 08T306 | ✓ | 25 | 25 | 34 | 200 | 125 | 144 | 56 | 239 € | | |
| SM42650 | SDUM 26XD5 SOMT 08T306 | ✓ | 26 | 25 | 34 | 205 | 130 | 149 | 56 | 239 € | SOMT 09T308 | |
| SM42667 | SDUM 27XD5 SOMT 09T308 | ✓ | 27 | 25 | 34 | 210 | 135 | 155 | 56 | 239 € | | |
| SM42674 | SDUM 28XD5 SOMT 09T308 | ✓ | 28 | 25 | 34 | 215 | 140 | 160 | 56 | 252 € | | |
| SM42681 | SDUM 29XD5 SOMT 09T308 | ✓ | 29 | 25 | 34 | 220 | 145 | 165 | 56 | 252 € | SOMT 09T308 | |
| SM42698 | SDUM 30XD5 SOMT 09T308 | ✓ | 30 | 32 | 44 | 231 | 150 | 170 | 60 | 265 € | | |

| Size Designation | Master Insert* | Spare Parts | | |
|------------------|----------------|--------------------|--------------|--------------------|
| | | Screw | Torx Key | Screw Torque Value |
| D14 - D16 | | SSV M2x5-9502 | | 0,6 |
| D16.5 - D19 | SOMT 060204 | SSV M2.2x5-9503 | | STK-T06-9906 |
| D19.5 - D22 | SOMT 070306 | SSV M2.5x6-9505 | STK-T08-9908 | 1,2 |
| D22.5 - D26 | SOMT 08T306 | | | |
| D26.5 - D30 | SOMT 09T308 | SSV M3.5x8-SC 9513 | STK-T15-9910 | 2,9 |

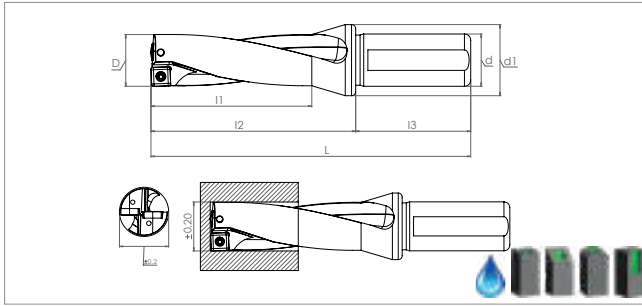
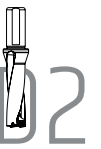

| Ordering Code | Item Designation | Dimensions (mm) | | | | | | | | Price | Master Insert* | |
|--|--------------------|---------------------|----|----|----|-----|----|----|----|-------|------------------------------------|------|
| | | POWER SERIES | D | d | d1 | L | l1 | l2 | l3 | | | EURO |
| SDUM Dx2 - SPMT/XOMT (PD) SPMT 050204 / 060205 / 07T208 / 090308 / 11T308 XOMT 050204 / 060204 / 07T205 / 090305 / 11T306 | | | | | | | | | | | | |
| SM59337 | SDUM 14XD2 SP-XO05 | ✓ | 14 | 20 | 25 | 96 | 28 | 46 | 50 | 132 € | | |
| SM59344 | SDUM 15XD2 SP-XO05 | ✓ | 15 | 20 | 25 | 99 | 30 | 49 | 50 | 132 € | SPMT(PD)050204 XOMT(PD)050204 | |
| SM59351 | SDUM 16XD2 SP-XO05 | ✓ | 16 | 25 | 34 | 108 | 32 | 52 | 56 | 132 € | | |
| SM59368 | SDUM 17XD2 SP-XO06 | ✓ | 17 | 25 | 34 | 110 | 34 | 54 | 56 | 132 € | | |
| SM59375 | SDUM 18XD2 SP-XO06 | ✓ | 18 | 25 | 34 | 113 | 36 | 57 | 56 | 132 € | SPMT(PD) 060205 XOMT(PD)060204 | |
| SM59382 | SDUM 19XD2 SP-XO06 | ✓ | 19 | 25 | 34 | 115 | 38 | 59 | 56 | 143 € | | |
| SM59399 | SDUM 20XD2 SP-XO07 | ✓ | 20 | 25 | 34 | 119 | 40 | 63 | 56 | 143 € | | |
| SM59405 | SDUM 21XD2 SP-XO07 | ✓ | 21 | 25 | 34 | 121 | 42 | 65 | 56 | 143 € | SPMT(PD) 07T208 XOMT(PD) 07T025 | |
| SM59412 | SDUM 22XD2 SP-XO07 | ✓ | 22 | 25 | 34 | 123 | 44 | 67 | 56 | 143 € | | |
| SM59429 | SDUM 23XD2 SP-XO07 | ✓ | 23 | 25 | 34 | 127 | 46 | 71 | 56 | 143 € | | |
| SM59436 | SDUM 24XD2 SP-XO09 | ✓ | 24 | 25 | 44 | 130 | 48 | 74 | 56 | 143 € | | |
| SM59443 | SDUM 25XD2 SP-XO09 | ✓ | 25 | 25 | 44 | 133 | 50 | 77 | 56 | 143 € | | |
| SM59450 | SDUM 26XD2 SP-XO09 | ✓ | 26 | 25 | 44 | 135 | 52 | 79 | 56 | 149 € | SPMT(PD) 090308 XOMT(PD)090305 | |
| SM59467 | SDUM 27XD2 SP-XO09 | ✓ | 27 | 25 | 44 | 137 | 54 | 81 | 56 | 149 € | | |
| SM59474 | SDUM 28XD2 SP-XO09 | ✓ | 28 | 25 | 44 | 140 | 56 | 84 | 56 | 149 € | | |
| SM59481 | SDUM 29XD2 SP-XO09 | ✓ | 29 | 25 | 44 | 142 | 58 | 86 | 56 | 149 € | | |
| SM59498 | SDUM 30XD2 SP-XO11 | ✓ | 30 | 32 | 44 | 141 | 60 | 81 | 60 | 160 € | SPMT(PD) 11T308 XOMT(PD) 11T306 | |

| Size Designation | Master Insert* | Spare Parts | | |
|------------------|------------------------------------|--------------------------|----------------------|--------------------|
| | | Screw | Torx Key | Screw Torque Value |
| | | | | N-m |
| D14 - D16 | SPMT(PD)050204 XOMT(PD) 050204 | SSV M2x4- 9521 | STK-T06- 9906 | 0,6 |
| D17 - D19 | SPMT(PD) 060205 XOMT(PD) 060204 | SSV M2.2x5- 9503 | | 0,85 |
| D20 - D23.5 | SPMT(PD) 07T208 XOMT(PD) 07T205 | SSV M2.5x6- 9505 | STK-T08- 9908 | 1,2 |
| D24 - D29 | SPMT(PD) 090308 XOMT(PD) 090305 | SSV M3x8- 9508 | STK-T08- 9908 | 1,9 |
| D30 | SPMT(PD) 11T308 XOMT(PD) 11T306 | SSV M3.5x10- 9511 | STK-T15- 9910 | 2,9 |

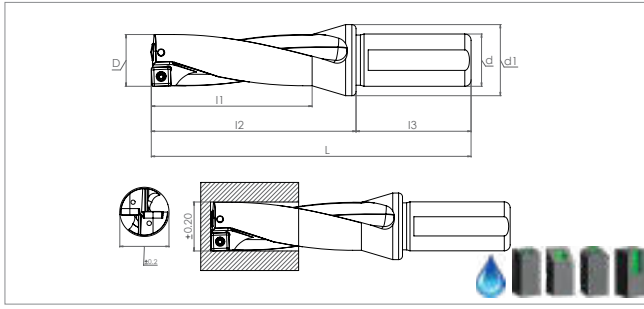

| Ordering Code | Item Designation | POWER SERIES | Dimensions (mm) | | | | | | | Price | Master Insert* |
|--|----------------------|--------------|-----------------|----|----|-----|------|----|----|-------|----------------------------------|
| | | | D | d | d1 | L | l1 | l2 | l3 | | |
| SDUM Dx3 - SPMT/XOMT (PD) SPMT 040204 / 050204 / 060205 / 07T208 XOMT 040204 / 050204 / 060204 / 07T205 | | | | | | | | | | EURO | |
| SM30039 | SDUM 12.5XD3 SP-XO04 | ✓ | 12.5 | 20 | 25 | 107 | 37 | 57 | 50 | 144 € | SPMT(PD)040204 XOMT(PD)040204 |
| SM30046 | SDUM 13XD3 SP-XO04 | ✓ | 13 | 20 | 25 | 107 | 39 | 57 | 50 | 144 € | |
| SM30053 | SDUM 13.5XD3 SP-XO04 | ✓ | 13.5 | 20 | 25 | 110 | 40.5 | 60 | 50 | 144 € | SPMT(PD)050204 XOMT(PD)050204 |
| SM37519 | SDUM 14XD3 SP-XO05 | ✓ | 14 | 20 | 25 | 110 | 42 | 60 | 50 | 144 € | |
| SM30077 | SDUM 14.5XD3 SP-XO05 | ✓ | 14.5 | 20 | 25 | 113 | 43.5 | 63 | 50 | 144 € | SPMT(PD)060205 XOMT(PD)060204 |
| SM37526 | SDUM 15XD3 SP-XO05 | ✓ | 15 | 20 | 25 | 113 | 45 | 63 | 50 | 144 € | |
| SM30091 | SDUM 15.5XD3 SP-XO05 | ✓ | 15.5 | 20 | 25 | 118 | 46.5 | 68 | 50 | 144 € | SPMT(PD)07T208 XOMT(PD)07T205 |
| SM38899 | SDUM 16XD3 SP-XO05 | ✓ | 16 | 25 | 34 | 124 | 48 | 68 | 56 | 144 € | |
| SM30114 | SDUM 16.5XD3 SP-XO06 | ✓ | 16.5 | 25 | 34 | 127 | 49.5 | 71 | 56 | 144 € | SPMT(PD)07T208 XOMT(PD)07T205 |
| SM30121 | SDUM 17XD3 SP-XO06 | ✓ | 17 | 25 | 34 | 127 | 51 | 71 | 56 | 144 € | |
| SM30510 | SDUM 17.5XD3 SP-XO06 | ✓ | 17.5 | 25 | 34 | 131 | 52.5 | 75 | 56 | 144 € | SPMT(PD)07T208 XOMT(PD)07T205 |
| SM30145 | SDUM 18XD3 SP-XO06 | ✓ | 18 | 25 | 34 | 131 | 54 | 75 | 56 | 144 € | |
| SM30152 | SDUM 18.5XD3 SP-XO06 | ✓ | 18.5 | 25 | 34 | 134 | 55.5 | 78 | 56 | 144 € | SPMT(PD)07T208 XOMT(PD)07T205 |
| SM30169 | SDUM 19XD3 SP-XO06 | ✓ | 19 | 25 | 34 | 134 | 57 | 78 | 56 | 144 € | |
| SM30176 | SDUM 19.5XD3 SP-XO06 | ✓ | 19.5 | 25 | 34 | 139 | 58.5 | 83 | 56 | 144 € | SPMT(PD)07T208 XOMT(PD)07T205 |
| SM30183 | SDUM 20XD3 SP-XO07 | ✓ | 20 | 25 | 34 | 139 | 60 | 83 | 56 | 147 € | |
| SM30190 | SDUM 20.5XD3 SP-XO07 | ✓ | 20.5 | 25 | 34 | 142 | 61.5 | 88 | 56 | 147 € | SPMT(PD)07T208 XOMT(PD)07T205 |
| SM30343 | SDUM 21XD3 SP-XO07 | ✓ | 21 | 25 | 34 | 142 | 63 | 88 | 56 | 147 € | |
| SM30206 | SDUM 21.5XD3 SP-XO07 | ✓ | 21.5 | 25 | 34 | 145 | 64.5 | 89 | 56 | 147 € | SPMT(PD)07T208 XOMT(PD)07T205 |
| SM30213 | SDUM 22XD3 SP-XO07 | ✓ | 22 | 25 | 34 | 145 | 66 | 89 | 56 | 147 € | |
| SM30220 | SDUM 22.5XD3 SP-XO07 | ✓ | 22.5 | 25 | 34 | 150 | 67.5 | 94 | 56 | 147 € | SPMT(PD)07T208 XOMT(PD)07T205 |
| SM30237 | SDUM 23XD3 SP-XO07 | ✓ | 23 | 25 | 34 | 150 | 69 | 94 | 56 | 147 € | |
| SM30244 | SDUM 23.5XD3 SP-XO07 | ✓ | 23.5 | 25 | 34 | 154 | 70.5 | 98 | 56 | 147 € | |

| Size Designation | Master Insert* | Spare Parts | | |
|------------------|------------------------------------|-----------------|--------------|--------------------|
| | | Screw | Torx Key | Screw Torque Value |
| D12.5 - D13.5 | | | | |
| D14 - D16 | SPMT(PD)040204 XOMT(PD) 040204 | SSV M2x4-9521 | STK-T06-9906 | 0,6 |
| D16.5 - D19.5 | SPMT(PD)050204 XOMT(PD) 050204 | | | |
| D20 - D23.5 | SPMT(PD) 060205 XOMT(PD) 060204 | SSV M2.2x5-9503 | STK-T08-9908 | 0,85 |
| | SPMT(PD) 07T208 XOMT(PD) 07T205 | SSV M2.5x6-9505 | | 1,2 |

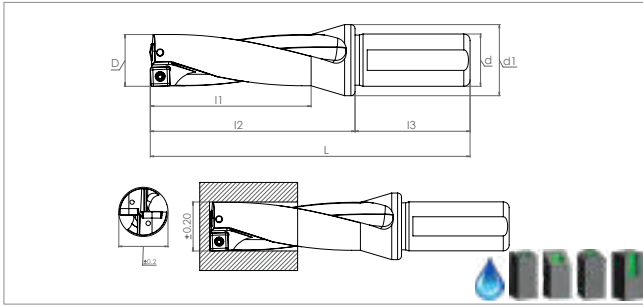

| Ordering Code | Item Designation | | Dimensions (mm) | | | | | | | Price | Master Insert* |
|---------------|--|---------------------|-----------------|----|----|-----|------|-----|----|-------|------------------------------------|
| | SDUM Dx3 - SPMT/XOMT (PD) SPMT 090308 / 11T308 / 130410 XOMT 090305 / 11T306 / 130416 | POWER SERIES | D | d | d1 | L | l1 | l2 | l3 | EURO | |
| SM30251 | SDUM 24XD3 SP-XO09 | ✓ | 24 | 25 | 34 | 154 | 72 | 98 | 56 | 147 € | SPMT(PD) 090308 XOMT(PD)090305 |
| SM30268 | SDUM 24.5XD3 SP-XO09 | ✓ | 24.5 | 25 | 34 | 158 | 73.5 | 102 | 56 | 147 € | |
| SM30275 | SDUM 25XD3 SP-XO09 | ✓ | 25 | 25 | 34 | 158 | 75 | 102 | 56 | 155 € | |
| SM30282 | SDUM 25.5XD3 SP-XO09 | ✓ | 25.5 | 25 | 34 | 161 | 76.5 | 105 | 56 | 155 € | |
| SM30299 | SDUM 26XD3 SP-XO09 | ✓ | 26 | 25 | 34 | 161 | 78 | 105 | 56 | 155 € | |
| SM30305 | SDUM 26.5XD3 SP-XO09 | ✓ | 26.5 | 25 | 34 | 164 | 79.5 | 108 | 56 | 155 € | |
| SM30312 | SDUM 27XD3 SP-XO09 | ✓ | 27 | 25 | 34 | 164 | 81 | 108 | 56 | 155 € | |
| SM30329 | SDUM 27.5XD3 SP-XO09 | ✓ | 27.5 | 25 | 34 | 168 | 82.5 | 112 | 56 | 155 € | |
| SM30336 | SDUM 28XD3 SP-XO09 | ✓ | 28 | 25 | 34 | 168 | 84 | 112 | 56 | 155 € | |
| SM30374 | SDUM 28.5XD3 SP-XO09 | ✓ | 28.5 | 25 | 34 | 171 | 85.5 | 115 | 56 | 155 € | |
| SM30367 | SDUM 29XD3 SP-XO09 | ✓ | 29 | 25 | 34 | 171 | 87 | 115 | 56 | 155 € | |
| SM30381 | SDUM 29.5XD3 SP-XO09 | ✓ | 29.5 | 25 | 34 | 177 | 88.5 | 111 | 56 | 155 € | |
| SM30398 | SDUM 30XD3 SP-XO11 | ✓ | 30 | 32 | 44 | 171 | 90 | 111 | 60 | 168 € | SPMT(PD) 11T308 XOMT(PD) 11T306 |
| SM59146 | SDUM 31XD3 SP-XO11 | ✓ | 31 | 32 | 44 | 175 | 93 | 115 | 60 | 171 € | |
| SM59160 | SDUM 32XD3 SP-XO11 | ✓ | 32 | 32 | 44 | 178 | 96 | 118 | 60 | 171 € | |
| SM59184 | SDUM 33XD3 SP-XO11 | ✓ | 33 | 32 | 44 | 182 | 99 | 122 | 60 | 171 € | |
| SM59207 | SDUM 34XD3 SP-XO11 | ✓ | 34 | 32 | 44 | 185 | 102 | 125 | 60 | 171 € | |
| SM59221 | SDUM 35XD3 SP-XO11 | ✓ | 35 | 32 | 44 | 189 | 105 | 129 | 60 | 171 € | |
| SM59245 | SDUM 36XD3 SP-XO13 | ✓ | 36 | 32 | 44 | 193 | 108 | 133 | 60 | 171 € | SPMT(PD) 130410 XOMT(PD) 130416 |
| SM59269 | SDUM 37XD3 SP-XO13 | ✓ | 37 | 32 | 44 | 197 | 111 | 136 | 60 | 171 € | |
| SM59283 | SDUM 38XD3 SP-XO13 | ✓ | 38 | 32 | 44 | 201 | 114 | 141 | 60 | 171 € | |
| SM59290 | SDUM 39XD3 SP-XO13 | ✓ | 39 | 32 | 44 | 204 | 117 | 144 | 60 | 171 € | |
| SM59306 | SDUM 40XD3 SP-XO13 | ✓ | 40 | 32 | 44 | 208 | 120 | 148 | 60 | 171 € | |
| SM59313 | SDUM 41XD3 SP-XO13 | ✓ | 41 | 32 | 44 | 212 | 123 | 152 | 60 | 193 € | |
| SM59320 | SDUM 42XD3 SP-XO13 | ✓ | 42 | 32 | 44 | 215 | 126 | 155 | 60 | 193 € | |

| Size Designation | Master Insert* | Spare Parts | | |
|------------------|--|----------------------|------------------|--------------------|
| | | Screw | Torx Key | Screw Torque Value |
| D24 - D29.5 | SPMT(PD) 090308 XOMT(PD) 090305 | SSV M3x8-9508 | STK-T08-9908 | 1,9 |
| D30 - D35 | SPMT(PD) 11T308 XOMT(PD) 11T306 | SSV M3.5x10-9511 | STK-T15-9910 | 2,9 |
| D36 - D42 | SPMT(PD) 130410 XOMT(PD) 130416 | SSV M4x10-9514 | | 4,3 |

U-Drills

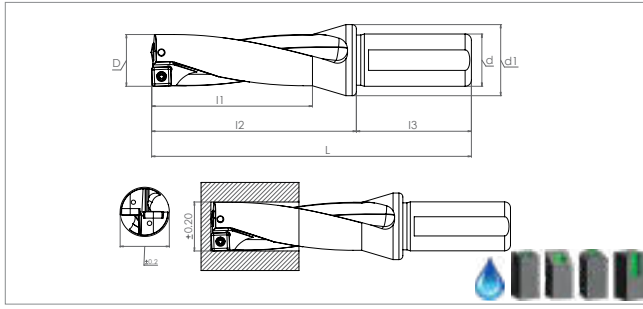

| Ordering Code | Item Designation | POWER SERIES | Dimensions (mm) | | | | | | | Price | Master Insert* | |
|---------------|--|--------------|-----------------|----|----|-----|-----|-----|----|-------|------------------------------------|--|
| | | | D | d | d1 | L | l1 | l2 | l3 | | | |
| | SDUM Dx4 - SPMT/XOMT (PD) SPMT 040204 / 050204 / 060205 / 07T208 XOMT 040204 / 050204 / 060204 / 07T205 | | | | | | | | | | EURO | |
| SM38905 | SDUM 12.5XD4 SP-XO04 | ✓ | 12.5 | 20 | 25 | 120 | 52 | 70 | 50 | 182 € | SPMT(PD)040204 XOMT(PD)040204 | |
| SM30411 | SDUM 13XD4 SP-XO04 | ✓ | 13 | 20 | 25 | 120 | 52 | 70 | 50 | 182 € | | |
| SM38912 | SDUM 13.5XD4 SP-XO04 | ✓ | 13.5 | 20 | 25 | 120 | 52 | 70 | 50 | 182 € | | |
| SM30435 | SDUM 14XD4 SP-XO05 | ✓ | 14 | 20 | 25 | 124 | 56 | 73 | 50 | 182 € | SPMT(PD)050204 XOMT(PD)050204 | |
| SM38882 | SDUM 14.5XD4 SP-XO05 | ✓ | 14.5 | 20 | 25 | 124 | 56 | 78 | 50 | 182 € | | |
| SM30459 | SDUM 15XD4 SP-XO05 | ✓ | 15 | 20 | 25 | 128 | 60 | 78 | 50 | 182 € | | |
| SM30466 | SDUM 15.5XD4 SP-XO05 | ✓ | 15.5 | 20 | 25 | 128 | 60 | 85 | 50 | 182 € | SPMT(PD)060205 XOMT(PD)060204 | |
| SM30473 | SDUM 16XD4 SP-XO05 | ✓ | 16 | 25 | 34 | 140 | 64 | 84 | 56 | 189 € | | |
| SM38790 | SDUM 16.5XD4 SP-XO06 | ✓ | 16.5 | 25 | 34 | 144 | 66 | 84 | 56 | 189 € | | |
| SM30497 | SDUM 17XD4 SP-XO06 | ✓ | 17 | 25 | 34 | 144 | 68 | 88 | 56 | 189 € | SPMT(PD) 07T208 XOMT(PD) 07T205 | |
| SM30527 | SDUM 17.5XD4 SP-XO06 | ✓ | 17.5 | 25 | 34 | 149 | 70 | 88 | 56 | 189 € | | |
| SM30534 | SDUM 18XD4 SP-XO06 | ✓ | 18 | 25 | 34 | 149 | 72 | 93 | 56 | 189 € | | |
| SM30541 | SDUM 18.5XD4 SP-XO06 | ✓ | 18.5 | 25 | 34 | 153 | 74 | 93 | 56 | 189 € | SPMT(PD) 090308 XOMT(PD)090305 | |
| SM30558 | SDUM 19XD4 SP-XO06 | ✓ | 19 | 25 | 34 | 153 | 76 | 97 | 56 | 189 € | | |
| SM30565 | SDUM 19.5XD4 SP-XO06 | ✓ | 19.5 | 25 | 34 | 159 | 78 | 97 | 56 | 189 € | | |
| SM30572 | SDUM 20XD4 SP-XO07 | ✓ | 20 | 25 | 34 | 159 | 80 | 103 | 56 | 189 € | SPMT(PD) 11T308 XOMT(PD) 11T306 | |
| SM30589 | SDUM 20.5XD4 SP-XO07 | ✓ | 20.5 | 25 | 34 | 163 | 82 | 103 | 56 | 189 € | | |
| SM30732 | SDUM 21XD4 SP-XO07 | ✓ | 21 | 25 | 34 | 163 | 84 | 107 | 56 | 195 € | | |
| SM30596 | SDUM 21.5XD4 SP-XO07 | ✓ | 21.5 | 25 | 34 | 167 | 86 | 107 | 56 | 195 € | SPMT(PD) 090308 XOMT(PD)090305 | |
| SM30602 | SDUM 22XD4 SP-XO07 | ✓ | 22 | 25 | 34 | 167 | 88 | 111 | 56 | 195 € | | |
| SM30619 | SDUM 22.5XD4 SP-XO07 | ✓ | 22.5 | 25 | 34 | 173 | 90 | 111 | 56 | 195 € | | |
| SM30626 | SDUM 23XD4 SP-XO07 | ✓ | 23 | 25 | 34 | 173 | 92 | 117 | 56 | 195 € | SPMT(PD) 11T308 XOMT(PD) 11T306 | |
| SM30633 | SDUM 23.5XD4 SP-XO07 | ✓ | 23.5 | 25 | 34 | 178 | 94 | 117 | 56 | 195 € | | |
| SM30640 | SDUM 24XD4 SP-XO09 | ✓ | 24 | 25 | 34 | 178 | 96 | 122 | 56 | 195 € | | |
| SM30657 | SDUM 24.5XD4 SP-XO09 | ✓ | 24.5 | 25 | 34 | 183 | 98 | 122 | 56 | 195 € | SPMT(PD) 090308 XOMT(PD)090305 | |
| SM30664 | SDUM 25XD4 SP-XO09 | ✓ | 25 | 25 | 34 | 183 | 100 | 127 | 56 | 195 € | | |
| SM30671 | SDUM 25.5XD4 SP-XO09 | ✓ | 25.5 | 25 | 34 | 187 | 102 | 127 | 56 | 195 € | | |
| SM30688 | SDUM 26XD4 SP-XO09 | ✓ | 26 | 25 | 34 | 187 | 104 | 131 | 56 | 212 € | SPMT(PD) 11T308 XOMT(PD) 11T306 | |
| SM30695 | SDUM 26.5XD4 SP-XO09 | ✓ | 26.5 | 25 | 34 | 191 | 106 | 131 | 56 | 212 € | | |
| SM30701 | SDUM 27XD4 SP-XO09 | ✓ | 27 | 25 | 34 | 191 | 108 | 135 | 56 | 212 € | | |
| SM30718 | SDUM 27.5XD4 SP-XO09 | ✓ | 27.5 | 25 | 34 | 196 | 110 | 135 | 56 | 212 € | SPMT(PD) 11T308 XOMT(PD) 11T306 | |
| SM30725 | SDUM 28XD4 SP-XO09 | ✓ | 28 | 25 | 34 | 196 | 112 | 140 | 56 | 212 € | | |
| SM30756 | SDUM 28.5XD4 SP-XO09 | ✓ | 28.5 | 25 | 34 | 200 | 114 | 140 | 56 | 212 € | | |
| SM30749 | SDUM 29XD4 SP-XO09 | ✓ | 29 | 25 | 34 | 200 | 116 | 144 | 56 | 212 € | SPMT(PD) 11T308 XOMT(PD) 11T306 | |
| SM30763 | SDUM 29.5XD4 SP-XO09 | ✓ | 29.5 | 25 | 34 | 202 | 118 | 144 | 56 | 212 € | | |
| SM30770 | SDUM 30XD4 SP-XO11 | ✓ | 30 | 32 | 44 | 201 | 120 | 141 | 60 | 221 € | | |

| Size Designation | Master Insert* | Spare Parts | | |
|------------------|----------------|-------------|----------|--------------------|
| | | Screw | Torx Key | Screw Torque Value |
| D12.5 - D13.5 | | | | N-m |
| D14 - D16 | | | | |
| D16.5 - D19.5 | | | | N-m |
| D20 - D23.5 | | | | |
| D24 - D29.5 | | | | N-m |
| D30 | | | | |

*Suitable Insert brand is KRLY

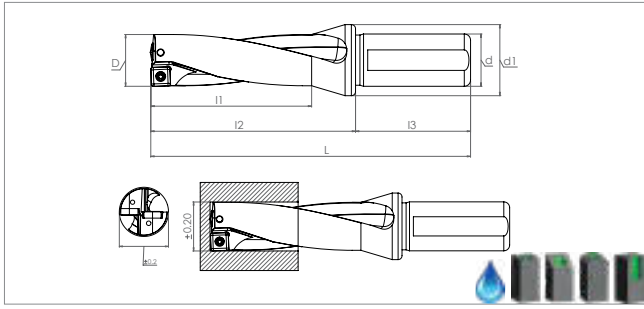

| Ordering Code | Item Designation | Dimensions (mm) | | | | | | | | Price | Master Insert* |
|--|--------------------|------------------------|----|----|----|-----|-----|-----|----|-------|------------------------------------|
| SDUM Dx5 - SPMT/XOMT (PD) SPMT 040204 / 050204 / 060205 / 07T208 XOMT 040204 / 050204 / 060204 / 07T205 | | POWER SERIES | D | d | d1 | L | l1 | l2 | l3 | EURO | |
| SM30787 | SDUM 13XD5 SP-XO04 | ✓ | 13 | 20 | 25 | 130 | 65 | 80 | 50 | 182 € | SPMT(PD)040204 XOMT(PD)040204 |
| SM30794 | SDUM 14XD5 SP-XO05 | ✓ | 14 | 20 | 25 | 135 | 70 | 85 | 50 | 182 € | |
| SM30800 | SDUM 15XD5 SP-XO05 | ✓ | 15 | 20 | 25 | 140 | 75 | 90 | 50 | 182 € | SPMT(PD)050204 XOMT(PD)050204 |
| SM30817 | SDUM 16XD5 SP-XO05 | ✓ | 16 | 25 | 34 | 155 | 80 | 100 | 56 | 216 € | |
| SM30824 | SDUM 17XD5 SP-XO06 | ✓ | 17 | 25 | 34 | 160 | 85 | 105 | 56 | 216 € | SPMT(PD) 060205 XOMT(PD)060204 |
| SM30831 | SDUM 18XD5 SP-XO06 | ✓ | 18 | 25 | 34 | 165 | 90 | 111 | 56 | 216 € | |
| SM30848 | SDUM 19XD5 SP-XO06 | ✓ | 19 | 25 | 34 | 170 | 95 | 116 | 56 | 216 € | SPMT(PD) 07T208 XOMT(PD) 07T205 |
| SM30855 | SDUM 20XD5 SP-XO07 | ✓ | 20 | 25 | 34 | 175 | 100 | 120 | 56 | 229 € | |
| SM30862 | SDUM 21XD5 SP-XO07 | ✓ | 21 | 25 | 34 | 180 | 105 | 124 | 56 | 229 € | SPMT(PD) 090308 XOMT(PD)090305 |
| SM30879 | SDUM 22XD5 SP-XO07 | ✓ | 22 | 25 | 34 | 185 | 110 | 129 | 56 | 229 € | |
| SM30886 | SDUM 23XD5 SP-XO07 | ✓ | 23 | 25 | 34 | 190 | 115 | 135 | 56 | 242 € | SPMT(PD) 11T308 XOMT(PD) 11T306 |
| SM30893 | SDUM 24XD5 SP-XO09 | ✓ | 24 | 25 | 34 | 195 | 120 | 140 | 56 | 242 € | |
| SM30909 | SDUM 25XD5 SP-XO09 | ✓ | 25 | 25 | 34 | 200 | 125 | 144 | 56 | 242 € | SPMT(PD) 090308 XOMT(PD)090305 |
| SM30916 | SDUM 26XD5 SP-XO09 | ✓ | 26 | 25 | 34 | 205 | 130 | 149 | 56 | 242 € | |
| SM30923 | SDUM 27XD5 SP-XO09 | ✓ | 27 | 25 | 34 | 210 | 135 | 155 | 56 | 242 € | SPMT(PD) 11T308 XOMT(PD) 11T306 |
| SM30930 | SDUM 28XD5 SP-XO09 | ✓ | 28 | 25 | 34 | 215 | 140 | 160 | 56 | 255 € | |
| SM30947 | SDUM 29XD5 SP-XO09 | ✓ | 29 | 25 | 34 | 220 | 145 | 165 | 56 | 255 € | SPMT(PD) 11T308 XOMT(PD) 11T306 |
| SM50440 | SDUM 30XD5 SP-XO11 | ✓ | 30 | 32 | 44 | 231 | 150 | 170 | 60 | 268 € | |

| Size Designation | Master Insert* | Spare Parts | | |
|------------------|---------------------------------------|-------------------|------------------|--------------------|
| | | Screw | Torx Key | Screw Torque Value |
| D13 | SPMT(PD)040204 XOMT(PD) 040204 | SSV M2x4-9521 | STK-T06-9906 | 0,6 |
| D14 - D16 | SPMT(PD)050204 XOMT(PD) 050204 | SSV M2.2x5-9503 | STK-T08-9908 | 0,85 |
| D17 - D19 | SPMT(PD) 060205 XOMT(PD) 060204 | | | |
| D20 - D23 | SPMT(PD) 07T208 XOMT(PD) 07T205 | SSV M2.5x6-9505 | STK-T08-9908 | 1,2 |
| D24 - D29 | SPMT(PD) 090308 XOMT(PD) 090305 | SSV M3x8-9508 | STK-T08-9908 | 1,9 |
| D30 | SPMT(PD) 11T308 XOMT(PD) 11T306 | SSV M3.5x10-9511 | STK-T15-9910 | 2,9 |

U-Drills

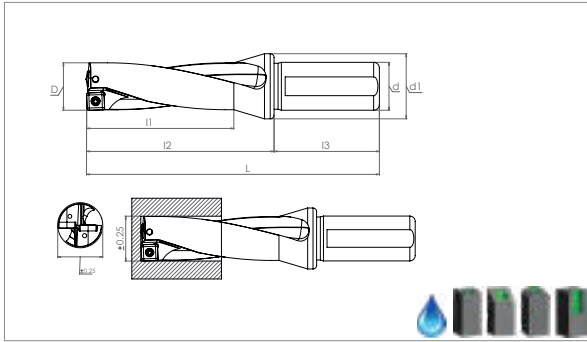

| Ordering Code | Item Designation | POWER SERIES | Dimensions (mm) | | | | | | | Price | Master Insert* | |
|--|--------------------|--------------|-----------------|----|----|-----|-----|-----|----|-------|------------------------------------|--|
| | | | D | d | d1 | L | l1 | l2 | l3 | | | |
| SDUM Dx6 - SPMT/XOMT (PD) SPMT 040204 / 050204 / 060205 / 07T208 XOMT 040204 / 050204 / 060204 / 07T205 | | | | | | | | | | | EURO | |
| SM60852 | SDUM 16XD6 SP-XO05 | ✓ | 16 | 25 | 34 | 172 | 96 | 116 | 56 | 352 € | SPMT(PD)050204 XOMT(PD)050204 | |
| SM60869 | SDUM 17XD6 SP-XO06 | ✓ | 17 | 25 | 34 | 178 | 102 | 122 | 56 | 352 € | | |
| SM60876 | SDUM 18XD6 SP-XO06 | ✓ | 18 | 25 | 34 | 184 | 108 | 128 | 56 | 352 € | SPMT(PD) 060205 XOMT(PD)060204 | |
| SM60883 | SDUM 19XD6 SP-XO06 | ✓ | 19 | 25 | 34 | 190 | 114 | 134 | 56 | 352 € | | |
| SM60890 | SDUM 20XD6 SP-XO07 | ✓ | 20 | 25 | 34 | 196 | 120 | 140 | 56 | 369 € | | |
| SM60906 | SDUM 21XD6 SP-XO07 | ✓ | 21 | 25 | 34 | 202 | 126 | 146 | 56 | 369 € | SPMT(PD) 07T208 XOMT(PD) 07T025 | |
| SM60913 | SDUM 22XD6 SP-XO07 | ✓ | 22 | 25 | 34 | 208 | 132 | 152 | 56 | 369 € | | |
| SM60920 | SDUM 23XD6 SP-XO07 | ✓ | 23 | 25 | 34 | 214 | 138 | 158 | 56 | 369 € | | |
| SM60937 | SDUM 24XD6 SP-XO09 | ✓ | 24 | 25 | 34 | 220 | 144 | 164 | 56 | 380 € | | |
| SM60944 | SDUM 25XD6 SP-XO09 | ✓ | 25 | 25 | 34 | 226 | 150 | 170 | 56 | 380 € | | |
| SM60951 | SDUM 26XD6 SP-XO09 | ✓ | 26 | 25 | 34 | 232 | 156 | 176 | 56 | 380 € | SPMT(PD) 090308 XOMT(PD)090305 | |
| SM60968 | SDUM 27XD6 SP-XO09 | ✓ | 27 | 25 | 34 | 238 | 162 | 182 | 56 | 380 € | | |
| SM60975 | SDUM 28XD6 SP-XO09 | ✓ | 28 | 25 | 34 | 244 | 168 | 188 | 56 | 380 € | | |
| SM60982 | SDUM 29XD6 SP-XO09 | ✓ | 29 | 25 | 34 | 250 | 174 | 194 | 56 | 380 € | | |
| SM60999 | SDUM 30XD6 SP-XO11 | ✓ | 30 | 32 | 44 | 260 | 180 | 200 | 60 | 407 € | SPMT(PD) 11T308 XOMT(PD) 11T306 | |

| Size Designation | Master Insert* | Spare Parts | | |
|------------------|------------------------------------|--------------------------|----------------------|--------------------|
| | | Screw | Torx Key | Screw Torque Value |
| D16 | | SSV M2x4- 9521 | STK-T06- 9906 | 0,6 |
| D17 - D19 | SPMT(PD) 060205 XOMT(PD) 060204 | SSV M2.2x5- 9503 | | 0,85 |
| D20 - D23 | SPMT(PD) 07T208 XOMT(PD) 07T205 | SSV M2.5x6- 9505 | STK-T08- 9908 | 1,2 |
| D24 - D29 | SPMT(PD) 090308 XOMT(PD) 090305 | SSV M3x8- 9508 | STK-T08- 9908 | 1,9 |
| D30 | SPMT(PD) 11T308 XOMT(PD) 11T306 | SSV M3.5x10- 9511 | STK-T15- 9910 | 2,9 |

*Suitable Insert brand is KRLY

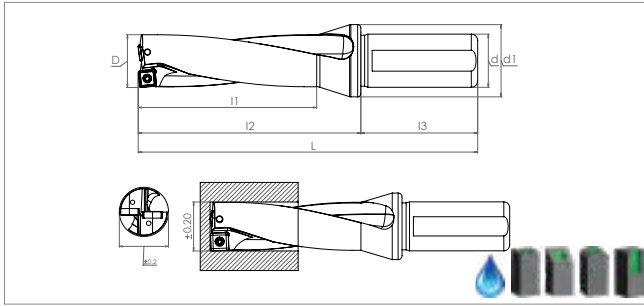
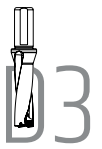

| Ordering Code | Item Designation | POWER SERIES | Dimensions (mm) | | | | | | | Price | Master Insert* | |
|---------------|---|--------------|-----------------|----|----|-----|------|-----|----|-------|-------------------|--|
| | | | D | d | d1 | L | l1 | l2 | l3 | | | |
| | SDUM Dx3 - SPGT 050204 / 060204 / 07T308 U-DRILL | | | | | | | | | | EURO | |
| SM40595 | SDUM 13XD3 SPGT 050204 | ✓ | 13 | 20 | 25 | 107 | 39 | 57 | 50 | 136 € | SPGT 050204 PM/EM | |
| SM40601 | SDUM 13.5XD3 SPGT 050204 | ✓ | 13.5 | 20 | 25 | 110 | 40.5 | 60 | 50 | 136 € | | |
| SM40618 | SDUM 14XD3 SPGT 050204 | ✓ | 14 | 20 | 25 | 110 | 42 | 60 | 50 | 136 € | | |
| SM40625 | SDUM 14.5XD3 SPGT 050204 | ✓ | 14.5 | 20 | 25 | 113 | 43.5 | 63 | 50 | 136 € | | |
| SM40632 | SDUM 15XD3 SPGT 050204 | ✓ | 15 | 20 | 25 | 113 | 45 | 63 | 50 | 136 € | | |
| SM40649 | SDUM 15.5XD3 SPGT 060204 | ✓ | 15.5 | 20 | 25 | 118 | 46.5 | 68 | 50 | 136 € | SPGT 060204 PM/EM | |
| SM40656 | SDUM 16XD3 SPGT 060204 | ✓ | 16 | 25 | 34 | 124 | 48 | 68 | 56 | 136 € | | |
| SM40663 | SDUM 16.5XD3 SPGT 060204 | ✓ | 16.5 | 25 | 34 | 127 | 49.5 | 71 | 56 | 136 € | | |
| SM40670 | SDUM 17XD3 SPGT 060204 | ✓ | 17 | 25 | 34 | 127 | 51 | 71 | 56 | 136 € | | |
| SM40687 | SDUM 17.5XD3 SPGT 060204 | ✓ | 17.5 | 25 | 34 | 131 | 52.5 | 75 | 56 | 136 € | | |
| SM40694 | SDUM 18XD3 SPGT 060204 | ✓ | 18 | 25 | 34 | 131 | 54 | 75 | 56 | 136 € | | |
| SM40700 | SDUM 18.5XD3 SPGT 060204 | ✓ | 18.5 | 25 | 34 | 134 | 55.5 | 78 | 56 | 136 € | | |
| SM40717 | SDUM 19XD3 SPGT 060204 | ✓ | 19 | 25 | 34 | 134 | 57 | 78 | 56 | 136 € | | |
| SM40724 | SDUM 19.5XD3 SPGT 060204 | ✓ | 19.5 | 25 | 34 | 139 | 58.5 | 83 | 56 | 136 € | | |
| SM40731 | SDUM 20XD3 SPGT 060204 | ✓ | 20 | 25 | 34 | 139 | 60 | 83 | 56 | 142 € | | |
| SM40748 | SDUM 20.5XD3 SPGT 060204 | ✓ | 20.5 | 25 | 34 | 142 | 61.5 | 88 | 56 | 142 € | | |
| SM40755 | SDUM 21XD3 SPGT 060204 | ✓ | 21 | 25 | 34 | 142 | 63 | 88 | 56 | 142 € | | |
| SM40762 | SDUM 21.5XD3 SPGT 060204 | ✓ | 21.5 | 25 | 34 | 145 | 64.5 | 89 | 56 | 142 € | | |
| SM40779 | SDUM 22XD3 SPGT 07T308 | ✓ | 22 | 25 | 34 | 145 | 66 | 89 | 56 | 142 € | SPGT 07T308 PM/EM | |
| SM40786 | SDUM 22.5XD3 SPGT 07T308 | ✓ | 22.5 | 25 | 34 | 150 | 67.5 | 94 | 56 | 142 € | | |
| SM40793 | SDUM 23XD3 SPGT 07T308 | ✓ | 23 | 25 | 34 | 150 | 69 | 94 | 56 | 142 € | | |
| SM40809 | SDUM 23.5XD3 SPGT 07T308 | ✓ | 23.5 | 25 | 34 | 154 | 70.5 | 98 | 56 | 142 € | | |
| SM40816 | SDUM 24XD3 SPGT 07T308 | ✓ | 24 | 25 | 34 | 154 | 72 | 98 | 56 | 145 € | | |
| SM40823 | SDUM 24.5XD3 SPGT 07T308 | ✓ | 24.5 | 25 | 34 | 158 | 73.5 | 102 | 56 | 145 € | | |
| SM40830 | SDUM 25XD3 SPGT 07T308 | ✓ | 25 | 25 | 34 | 158 | 75 | 102 | 56 | 145 € | | |
| SM40854 | SDUM 26XD3 SPGT 07T308 | ✓ | 26 | 25 | 34 | 161 | 78 | 105 | 56 | 145 € | | |
| SM40878 | SDUM 27XD3 SPGT 07T308 | ✓ | 27 | 25 | 34 | 164 | 81 | 108 | 56 | 145 € | | |

| Size Designation | Master Insert* | Spare Parts | | |
|------------------|-------------------|-----------------|--------------|--------------------|
| | | Screw | Torx Key | Screw Torque Value |
| D13 - D15 | | | | N-m |
| D15.5 - D21.5 | SPGT 050204 PM/EM | SSV M2x4-9521 | STK-T06-9906 | 0,6 |
| D22 - D27 | SPGT 060204 PM/EM | SSV M2.2x5-9503 | | 0,85 |
| | SPGT 07T308 PM/EM | SSV M2.5x7-9506 | STK-T08-9908 | 1,2 |

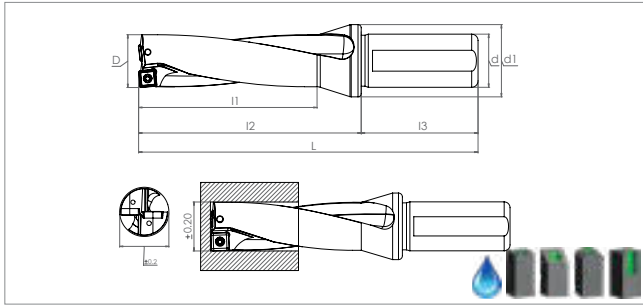

| Ordering Code | Item Designation | POWER SERIES | Dimensions (mm) | | | | | | | Price | Master Insert* |
|---------------|--|--------------|-----------------|----|----|-----|-----|-----|----|-------|-------------------|
| | | | D | d | d1 | L | l1 | l2 | l3 | | |
| | SDUM Dx3 - SPGT 090408 / 110408 U-DRILL | | | | | | | | | EURO | |
| SM40892 | SDUM 28XD3 SPGT 090408 | ✓ | 28 | 25 | 34 | 168 | 84 | 112 | 56 | 145 € | SPGT 090408 PM/EM |
| SM40915 | SDUM 29XD3 SPGT 090408 | ✓ | 29 | 25 | 34 | 171 | 87 | 115 | 56 | 145 € | |
| SM40939 | SDUM 30XD3 SPGT 090408 | ✓ | 30 | 32 | 44 | 171 | 90 | 111 | 60 | 158 € | |
| SM40946 | SDUM 31XD3 SPGT 090408 | ✓ | 31 | 32 | 44 | 175 | 93 | 115 | 60 | 158 € | |
| SM40953 | SDUM 32XD3 SPGT 090408 | ✓ | 32 | 32 | 44 | 178 | 96 | 118 | 60 | 158 € | |
| SM40960 | SDUM 33XD3 SPGT 090408 | ✓ | 33 | 32 | 44 | 182 | 99 | 122 | 60 | 158 € | |
| SM40977 | SDUM 34XD3 SPGT 110408 | ✓ | 34 | 32 | 44 | 185 | 102 | 125 | 60 | 158 € | SPGT 110408 PM/EM |
| SM40984 | SDUM 35XD3 SPGT 110408 | ✓ | 35 | 32 | 44 | 189 | 105 | 129 | 60 | 158 € | |
| SM40991 | SDUM 36XD3 SPGT 110408 | ✓ | 36 | 32 | 44 | 193 | 108 | 133 | 60 | 158 € | |
| SM41004 | SDUM 37XD3 SPGT 110408 | ✓ | 37 | 32 | 44 | 197 | 111 | 136 | 60 | 158 € | |
| SM41011 | SDUM 38XD3 SPGT 110408 | ✓ | 38 | 32 | 44 | 201 | 114 | 141 | 60 | 158 € | |
| SM41028 | SDUM 39XD3 SPGT 110408 | ✓ | 39 | 32 | 44 | 204 | 117 | 144 | 60 | 158 € | |
| SM41035 | SDUM 40XD3 SPGT 110408 | ✓ | 40 | 32 | 44 | 208 | 120 | 148 | 60 | 158 € | |

| Size Designation | Master Insert* | Spare Parts | | |
|------------------|----------------|-------------------------|------------------|--------------------|
| | | Screw | Torx Key | Screw Torque Value |
| D28 - D33 | | SSV M3.5x10-9511 | STK-T15-9910 | N·m 2,9 |
| D34 - D40 | | SSV M4x10-9514 | | N·m 4,3 |



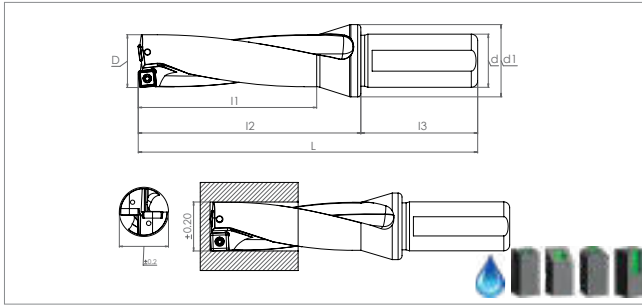

| Ordering Code | Item Designation | POWER SERIES | Dimensions (mm) | | | | | | | Price | Master Insert* | |
|---|------------------------|--------------|-----------------|----|----|-----|-----|-----|----|-------|-------------------|--|
| | | | D | d | d1 | L | l1 | l2 | l3 | | | |
| SDUM Dx4 - SPGT 050204/060204/07T308/090408 U-DRILL | | | | | | | | | | | EURO | |
| SM41141 | SDUM 13XD4 SPGT 050204 | ✓ | 13 | 20 | 25 | 120 | 52 | 70 | 50 | 165 € | SPGT 050204 PM/EM | |
| SM41158 | SDUM 14XD4 SPGT 050204 | ✓ | 14 | 20 | 25 | 124 | 56 | 73 | 50 | 165 € | | |
| SM41165 | SDUM 15XD4 SPGT 050204 | ✓ | 15 | 20 | 25 | 128 | 60 | 78 | 50 | 165 € | | |
| SM41172 | SDUM 16XD4 SPGT 060204 | ✓ | 16 | 25 | 34 | 140 | 64 | 84 | 56 | 165 € | SPGT 060204 PM/EM | |
| SM41189 | SDUM 17XD4 SPGT 060204 | ✓ | 17 | 25 | 34 | 144 | 68 | 88 | 56 | 165 € | | |
| SM41196 | SDUM 18XD4 SPGT 060204 | ✓ | 18 | 25 | 34 | 149 | 72 | 93 | 56 | 165 € | | |
| SM41202 | SDUM 19XD4 SPGT 060204 | ✓ | 19 | 25 | 34 | 153 | 76 | 97 | 56 | 165 € | | |
| SM41219 | SDUM 20XD4 SPGT 060204 | ✓ | 20 | 25 | 34 | 159 | 80 | 103 | 56 | 171 € | | |
| SM41226 | SDUM 21XD4 SPGT 060204 | ✓ | 21 | 25 | 34 | 163 | 84 | 107 | 56 | 171 € | SPGT 07T308 PM/EM | |
| SM41233 | SDUM 22XD4 SPGT 07T308 | ✓ | 22 | 25 | 34 | 167 | 88 | 111 | 56 | 171 € | | |
| SM41240 | SDUM 23XD4 SPGT 07T308 | ✓ | 23 | 25 | 34 | 173 | 92 | 117 | 56 | 171 € | | |
| SM41257 | SDUM 24XD4 SPGT 07T308 | ✓ | 24 | 25 | 34 | 178 | 96 | 122 | 56 | 177 € | | |
| SM41264 | SDUM 25XD4 SPGT 07T308 | ✓ | 25 | 25 | 34 | 183 | 100 | 127 | 56 | 177 € | | |
| SM41271 | SDUM 26XD4 SPGT 07T308 | ✓ | 26 | 25 | 34 | 187 | 104 | 131 | 56 | 177 € | | |
| SM41288 | SDUM 27XD4 SPGT 07T308 | ✓ | 27 | 25 | 34 | 191 | 108 | 135 | 56 | 177 € | | |
| SM41295 | SDUM 28XD4 SPGT 090408 | ✓ | 28 | 25 | 34 | 196 | 112 | 140 | 56 | 177 € | SPGT 090408 PM/EM | |
| SM41301 | SDUM 29XD4 SPGT 090408 | ✓ | 29 | 25 | 34 | 200 | 116 | 144 | 56 | 177 € | | |
| SM41318 | SDUM 30XD4 SPGT 090408 | ✓ | 30 | 32 | 44 | 201 | 120 | 141 | 60 | 187 € | | |

| Size Designation | Master Insert* | Spare Parts | | |
|------------------|-------------------|------------------|--------------|--------------------|
| | | Screw | Torx Key | Screw Torque Value |
| D13 - D15 | | | | N-m |
| D15.5 - D21 | | | | 0,6 |
| D22 - D27 | SPGT 07T308 PM/EM | SSV M2.5x7-9506 | STK-T08-9908 | 0,85 |
| D28 - D30 | SPGT 090408 PM/EM | SSV M3.5x10-9511 | STK-T15-9910 | 1,2 |
| | | | | 2,9 |



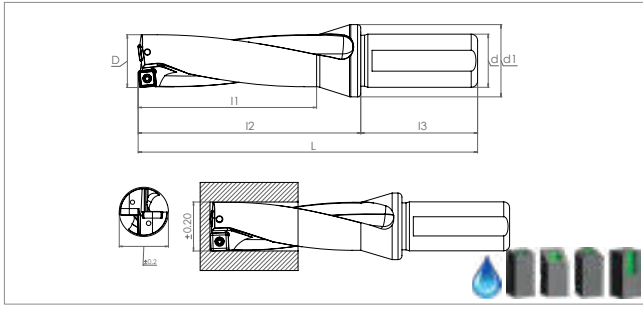

| Ordering Code | Item Designation | | Dimensions (mm) | | | | | | | | Price | Master Insert* |
|---------------|--|------------------------|-----------------|----------|-----------|----------|-----------|-----------|-----------|-------------|-------------------|----------------|
| | SDUM Dx5 - SPGT 050204/060204/07T308/090408 U-DRILL | POWER SERIES | <i>D</i> | <i>d</i> | <i>d1</i> | <i>L</i> | <i>l1</i> | <i>l2</i> | <i>l3</i> | <i>EURO</i> | | |
| SM41325 | SDUM 14XD5 SPGT 050204 | ✓ | 14 | 20 | 25 | 135 | 70 | 85 | 50 | 182 € | SPGT 050204 PM/EM | |
| SM41332 | SDUM 15XD5 SPGT 050204 | ✓ | 15 | 20 | 25 | 140 | 75 | 90 | 50 | 216 € | | |
| SM41349 | SDUM 16XD5 SPGT 060204 | ✓ | 16 | 25 | 34 | 155 | 80 | 100 | 56 | 216 € | SPGT 060204 PM/EM | |
| SM41356 | SDUM 17XD5 SPGT 060204 | ✓ | 17 | 25 | 34 | 160 | 85 | 105 | 56 | 216 € | | |
| SM41363 | SDUM 18XD5 SPGT 060204 | ✓ | 18 | 25 | 34 | 165 | 90 | 111 | 56 | 216 € | | |
| SM41370 | SDUM 19XD5 SPGT 060204 | ✓ | 19 | 25 | 34 | 170 | 95 | 116 | 56 | 216 € | | |
| SM41387 | SDUM 20XD5 SPGT 060204 | ✓ | 20 | 25 | 34 | 175 | 100 | 120 | 56 | 229 € | | |
| SM41394 | SDUM 21XD5 SPGT 060204 | ✓ | 21 | 25 | 34 | 180 | 105 | 124 | 56 | 229 € | | |
| SM41400 | SDUM 22XD5 SPGT 07T308 | ✓ | 22 | 25 | 34 | 185 | 110 | 129 | 56 | 229 € | SPGT 07T308 PM/EM | |
| SM41417 | SDUM 23XD5 SPGT 07T308 | ✓ | 23 | 25 | 34 | 190 | 115 | 135 | 56 | 242 € | | |
| SM41424 | SDUM 24XD5 SPGT 07T308 | ✓ | 24 | 25 | 34 | 195 | 120 | 140 | 56 | 242 € | | |
| SM41431 | SDUM 25XD5 SPGT 07T308 | ✓ | 25 | 25 | 34 | 200 | 125 | 144 | 56 | 242 € | | |
| SM41448 | SDUM 26XD5 SPGT 07T308 | ✓ | 26 | 25 | 34 | 205 | 130 | 149 | 56 | 242 € | | |
| SM41455 | SDUM 27XD5 SPGT 07T308 | ✓ | 27 | 25 | 34 | 210 | 135 | 155 | 56 | 242 € | SPGT 090408 PM/EM | |
| SM41462 | SDUM 28XD5 SPGT 090408 | ✓ | 28 | 25 | 34 | 215 | 140 | 160 | 56 | 255 € | | |
| SM41479 | SDUM 29XD5 SPGT 090408 | ✓ | 29 | 25 | 34 | 220 | 145 | 165 | 56 | 255 € | | |
| SM41486 | SDUM 30XD5 SPGT 090408 | ✓ | 30 | 32 | 44 | 231 | 150 | 170 | 60 | 268 € | | |

| Size Designation | Master Insert* | Spare Parts | | |
|------------------|----------------|----------------------|------------------|--------------------|
| | | Screw | Torx Key | Screw Torque Value |
| D13 - D15 | | SSV M2x4-9521 | STK-T06-9906 | 0,6 |
| D15.5 - D21 | | SSV M2.2x5-9503 | STK-T08-9908 | 0,85 |
| D22 - D27 | | SSV M2.5x7-9506 | STK-T15-9910 | 1,2 |
| D28 - D30 | | SSV M3.5x10-9511 | | 2,9 |

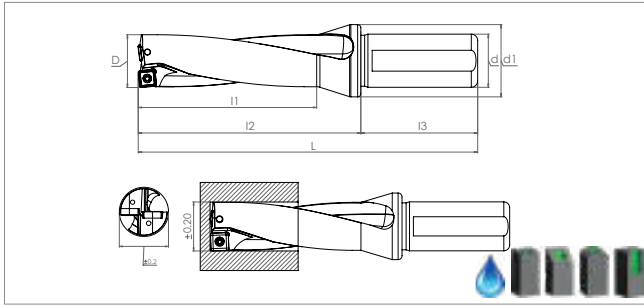

| Ordering Code | Item Designation | Dimensions (mm) | | | | | | | | Price | Master Insert* |
|---|-----------------------|------------------------|----|----|----|-----|-----|-----|----|-------|----------------|
| SDUM Dx3 - SOMX / SOMT 050204 / 060304 / 070305 / 09T306 / 120408 U-DRILL | | POWER SERIES | D | d | d1 | L | l1 | l2 | l3 | EURO | |
| SM41493 | SDUM 14XD3 SO..050204 | ✓ | 14 | 20 | 25 | 110 | 42 | 60 | 50 | 142 € | SOMX 050204 |
| SM41509 | SDUM 15XD3 SO..050204 | ✓ | 15 | 20 | 25 | 113 | 45 | 63 | 50 | 142 € | |
| SM41516 | SDUM 16XD3 SO..050204 | ✓ | 16 | 25 | 34 | 124 | 48 | 68 | 56 | 142 € | |
| SM41523 | SDUM 17XD3 SO..050204 | ✓ | 17 | 25 | 34 | 127 | 51 | 71 | 56 | 142 € | |
| SM41530 | SDUM 18XD3 SO..060304 | ✓ | 18 | 25 | 34 | 131 | 54 | 75 | 56 | 142 € | SOMX 060304 |
| SM41547 | SDUM 19XD3 SO..060304 | ✓ | 19 | 25 | 34 | 134 | 57 | 78 | 56 | 142 € | |
| SM41554 | SDUM 20XD3 SO..060304 | ✓ | 20 | 25 | 34 | 139 | 60 | 83 | 56 | 145 € | |
| SM41561 | SDUM 21XD3 SO..070305 | ✓ | 21 | 25 | 34 | 142 | 63 | 88 | 56 | 145 € | SOMX 070305 |
| SM41578 | SDUM 22XD3 SO..070305 | ✓ | 22 | 25 | 34 | 145 | 66 | 89 | 56 | 145 € | |
| SM41585 | SDUM 23XD3 SO..070305 | ✓ | 23 | 25 | 34 | 150 | 69 | 94 | 56 | 145 € | |
| SM41592 | SDUM 24XD3 SO..070305 | ✓ | 24 | 25 | 34 | 154 | 72 | 98 | 56 | 145 € | |
| SM41608 | SDUM 25XD3 SO..09T306 | ✓ | 25 | 25 | 34 | 158 | 75 | 102 | 56 | 152 € | SOMT 09T306 |
| SM41615 | SDUM 26XD3 SO..09T306 | ✓ | 26 | 25 | 34 | 161 | 78 | 105 | 56 | 152 € | |
| SM41622 | SDUM 27XD3 SO..09T306 | ✓ | 27 | 25 | 34 | 164 | 81 | 108 | 56 | 152 € | |
| SM41639 | SDUM 28XD3 SO..09T306 | ✓ | 28 | 25 | 34 | 168 | 84 | 112 | 56 | 152 € | |
| SM41646 | SDUM 29XD3 SO..09T306 | ✓ | 29 | 25 | 34 | 171 | 87 | 115 | 56 | 152 € | |
| SM41653 | SDUM 30XD3 SO..09T306 | ✓ | 30 | 32 | 44 | 171 | 90 | 111 | 60 | 166 € | |
| SM41660 | SDUM 31XD3 SO..09T306 | ✓ | 31 | 32 | 44 | 175 | 93 | 115 | 60 | 166 € | |
| SM41677 | SDUM 32XD3 SO..09T306 | ✓ | 32 | 32 | 44 | 178 | 96 | 118 | 60 | 166 € | |
| SM41684 | SDUM 33XD3 SO..09T306 | ✓ | 33 | 32 | 44 | 182 | 99 | 122 | 60 | 166 € | |
| SM41691 | SDUM 34XD3 SO..09T306 | ✓ | 34 | 32 | 44 | 185 | 102 | 125 | 60 | 166 € | |
| SM41707 | SDUM 35XD3 SO..120408 | ✓ | 35 | 32 | 44 | 189 | 105 | 129 | 60 | 166 € | SOMT 120408 |
| SM41714 | SDUM 36XD3 SO..120408 | ✓ | 36 | 32 | 44 | 193 | 108 | 133 | 60 | 166 € | |
| SM41721 | SDUM 37XD3 SO..120408 | ✓ | 37 | 32 | 44 | 197 | 111 | 136 | 60 | 166 € | |
| SM41738 | SDUM 38XD3 SO..120408 | ✓ | 38 | 32 | 44 | 201 | 114 | 141 | 60 | 166 € | |
| SM41745 | SDUM 39XD3 SO..120408 | ✓ | 39 | 32 | 44 | 204 | 117 | 144 | 60 | 166 € | |
| SM50457 | SDUM 40XD3 SO..120408 | ✓ | 40 | 32 | 44 | 208 | 120 | 148 | 60 | 166 € | |

| Size Designation | Master Insert* | Spare Parts | | |
|------------------|----------------|-----------------|--------------|---------------------------|
| | | Screw | Torx Key | Screw Torque Value N-m |
| D14 - D17 | SOMX 050204 | SSV M2x5-9502 | STK-T06-9906 | 0,6 |
| D18 - D20 | SOMX 060304 | SSV M2.2x5-9503 | | 0,85 |
| D21 - D24 | SOMX 070305 | SSV M2.5x6-9505 | STK-T08-9908 | 1,2 |
| D25 - D34 | SOMT 09T306 | SSV M3x7-9527 | | 1,9 |
| D35 - D40 | SOMT 120408 | SSV M4x10-9514 | STK-T15-9910 | 4,3 |

U-Drills

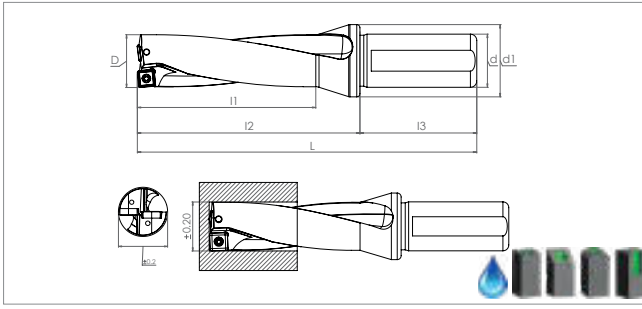

| Ordering Code | Item Designation | POWER SERIES | Dimensions (mm) | | | | | | | Price | Master Insert* |
|---|-----------------------|--------------|-----------------|----|----|-----|-----|-----|----|-------|----------------|
| | | | D | d | d1 | L | l1 | l2 | l3 | | |
| SDUM Dx4 - SOMX / SOMT 050204 / 060304 / 070305 / 09T306 / 120408 U-DRILL | | | | | | | | | | EURO | |
| SM41769 | SDUM 14XD4 SO..050204 | ✓ | 14 | 20 | 25 | 124 | 56 | 73 | 50 | 179 € | SOMX 050204 |
| SM41776 | SDUM 15XD4 SO..050204 | ✓ | 15 | 20 | 25 | 128 | 60 | 78 | 50 | 179 € | |
| SM41783 | SDUM 16XD4 SO..050204 | ✓ | 16 | 25 | 34 | 140 | 64 | 84 | 56 | 186 € | |
| SM41790 | SDUM 17XD4 SO..050204 | ✓ | 17 | 25 | 34 | 144 | 68 | 88 | 56 | 186 € | SOMX 060304 |
| SM41806 | SDUM 18XD4 SO..060304 | ✓ | 18 | 25 | 34 | 149 | 72 | 93 | 56 | 186 € | |
| SM41813 | SDUM 19XD4 SO..060304 | ✓ | 19 | 25 | 34 | 153 | 76 | 97 | 56 | 186 € | |
| SM41820 | SDUM 20XD4 SO..060304 | ✓ | 20 | 25 | 34 | 159 | 80 | 103 | 56 | 186 € | SOMX 070305 |
| SM41837 | SDUM 21XD4 SO..070305 | ✓ | 21 | 25 | 34 | 163 | 84 | 107 | 56 | 193 € | |
| SM41844 | SDUM 22XD4 SO..070305 | ✓ | 22 | 25 | 34 | 167 | 88 | 111 | 56 | 193 € | |
| SM41851 | SDUM 23XD4 SO..070305 | ✓ | 23 | 25 | 34 | 173 | 92 | 117 | 56 | 193 € | SOMT 09T306 |
| SM41868 | SDUM 24XD4 SO..070305 | ✓ | 24 | 25 | 34 | 178 | 96 | 122 | 56 | 193 € | |
| SM41875 | SDUM 25XD4 SO..09T306 | ✓ | 25 | 25 | 34 | 183 | 100 | 127 | 56 | 193 € | |
| SM41882 | SDUM 26XD4 SO..09T306 | ✓ | 26 | 25 | 34 | 187 | 104 | 131 | 56 | 209 € | SOMT 120408 |
| SM41899 | SDUM 27XD4 SO..09T306 | ✓ | 27 | 25 | 34 | 191 | 108 | 135 | 56 | 209 € | |
| SM41905 | SDUM 28XD4 SO..09T306 | ✓ | 28 | 25 | 34 | 196 | 112 | 140 | 56 | 209 € | |
| SM41912 | SDUM 29XD4 SO..09T306 | ✓ | 29 | 25 | 34 | 200 | 116 | 144 | 56 | 209 € | SOMT 09T306 |
| SM41929 | SDUM 30XD4 SO..09T306 | ✓ | 30 | 32 | 44 | 201 | 120 | 141 | 60 | 219 € | |
| SM41936 | SDUM 31XD4 SO..09T306 | ✓ | 31 | 32 | 44 | 206 | 124 | 145 | 60 | 219 € | |
| SM41943 | SDUM 32XD4 SO..09T306 | ✓ | 32 | 32 | 44 | 210 | 128 | 149 | 60 | 219 € | SOMT 120408 |
| SM41950 | SDUM 33XD4 SO..09T306 | ✓ | 33 | 32 | 44 | 215 | 132 | 154 | 60 | 219 € | |
| SM41967 | SDUM 34XD4 SO..09T306 | ✓ | 34 | 32 | 44 | 219 | 136 | 158 | 60 | 219 € | |
| SM41974 | SDUM 35XD4 SO..120408 | ✓ | 35 | 32 | 44 | 224 | 140 | 166 | 60 | 219 € | SOMT 120408 |
| SM41981 | SDUM 36XD4 SO..120408 | ✓ | 36 | 32 | 44 | 229 | 144 | 169 | 60 | 219 € | |
| SM41998 | SDUM 37XD4 SO..120408 | ✓ | 37 | 32 | 44 | 234 | 148 | 172 | 60 | 219 € | |
| SM42001 | SDUM 38XD4 SO..120408 | ✓ | 38 | 32 | 44 | 239 | 152 | 178 | 60 | 219 € | SOMT 120408 |
| SM42018 | SDUM 39XD4 SO..120408 | ✓ | 39 | 32 | 44 | 243 | 156 | 181 | 60 | 219 € | |
| SM42025 | SDUM 40XD4 SO..120408 | ✓ | 40 | 32 | 44 | 248 | 160 | 188 | 60 | 219 € | |

| Size Designation | Master Insert* | Spare Parts | | |
|------------------|----------------|-----------------|--------------|--------------------|
| | | Screw | Torx Key | Screw Torque Value |
| D14 - D17 | | SSV M2x5-9502 | STK-T06-9906 | 0,6 N-m |
| D18 - D20 | SOMX 060304 | SSV M2.2x5-9503 | STK-T08-9908 | 0,85 |
| D21 - D24 | SOMX 070305 | SSV M2.5x6-9505 | | 1,2 |
| D25 - D34 | SOMT 09T306 | SSV M3x7-9527 | STK-T15-9910 | 1,9 |
| D35 - D40 | SOMT 120408 | SSV M4x10-9514 | | 4,3 |

*Suitable Insert is ISC

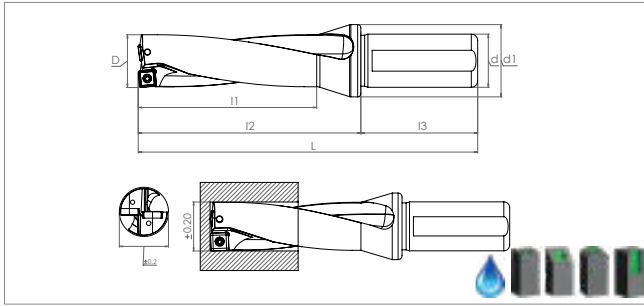



| Ordering Code | Item Designation | | Dimensions (mm) | | | | | | | Price | Master Insert* |
|---------------|--|------------------------|-----------------|----|----|-----|-----|-----|----|-------|----------------|
| | SDUM Dx5 - SOMX / SOMT 050204 / 060304 / 070305 / 09T306 U-DRILL | POWER SERIES | D | d | d1 | L | l1 | l2 | l3 | EURO | |
| SM48782 | SDUM 14XD5 SO..050204 | ✓ | 14 | 20 | 25 | 135 | 70 | 85 | 50 | 189 € | SOMX 050204 |
| SM48799 | SDUM 15XD5 SO..050204 | ✓ | 15 | 20 | 25 | 140 | 75 | 90 | 50 | 189 € | |
| SM48805 | SDUM 16XD5 SO..050204 | ✓ | 16 | 25 | 34 | 155 | 80 | 100 | 56 | 212 € | |
| SM48812 | SDUM 17XD5 SO..050204 | ✓ | 17 | 25 | 34 | 160 | 85 | 105 | 56 | 212 € | |
| SM48829 | SDUM 18XD5 SO..060304 | ✓ | 18 | 25 | 34 | 165 | 90 | 111 | 56 | 212 € | SOMX 060304 |
| SM48836 | SDUM 19XD5 SO..060304 | ✓ | 19 | 25 | 34 | 170 | 95 | 116 | 56 | 212 € | |
| SM48843 | SDUM 20XD5 SO..060304 | ✓ | 20 | 25 | 34 | 175 | 100 | 120 | 56 | 226 € | |
| SM48850 | SDUM 21XD5 SO..070305 | ✓ | 21 | 25 | 34 | 180 | 105 | 124 | 56 | 226 € | SOMX 070305 |
| SM48867 | SDUM 22XD5 SO..070305 | ✓ | 22 | 25 | 34 | 185 | 110 | 129 | 56 | 226 € | |
| SM48874 | SDUM 23XD5 SO..070305 | ✓ | 23 | 25 | 34 | 190 | 115 | 135 | 56 | 239 € | |
| SM48881 | SDUM 24XD5 SO..070305 | ✓ | 24 | 25 | 34 | 195 | 120 | 140 | 56 | 239 € | |
| SM48898 | SDUM 25XD5 SO..09T306 | ✓ | 25 | 25 | 34 | 200 | 125 | 144 | 56 | 239 € | SOMT 09T306 |
| SM48904 | SDUM 26XD5 SO..09T306 | ✓ | 26 | 25 | 34 | 205 | 130 | 149 | 56 | 239 € | |
| SM48911 | SDUM 27XD5 SO..09T306 | ✓ | 27 | 25 | 34 | 210 | 135 | 155 | 56 | 239 € | |
| SM48928 | SDUM 28XD5 SO..09T306 | ✓ | 28 | 25 | 34 | 215 | 140 | 160 | 56 | 252 € | |
| SM48935 | SDUM 29XD5 SO..09T306 | ✓ | 29 | 25 | 34 | 220 | 145 | 165 | 56 | 252 € | |
| SM48942 | SDUM 30XD5 SO..09T306 | ✓ | 30 | 32 | 44 | 231 | 150 | 170 | 60 | 265 € | |



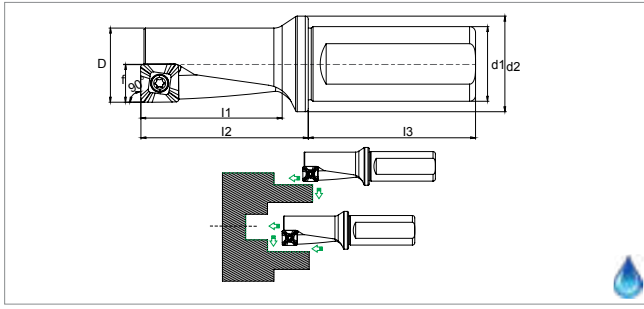

| Size Designation | Master Insert* | Spare Parts | | |
|------------------|----------------|-----------------|--------------|--------------------|
| | | Screw | Torx Key | Screw Torque Value |
| D14 - D17 | SOMX 050204 | SSV M2x5-9502 | STK-T06-9906 | 0,6 |
| D18 - D20 | SOMX 060304 | SSV M2.2x5-9503 | | 0,85 |
| D21 - D24 | SOMX 070305 | SSV M2.5x6-9505 | STK-T08-9908 | 1,2 |
| D25 - D30 | SOMT 09T306 | SSV M3x7-9527 | | 1,9 |



MULTI CUT POWER SERIES



| Ordering Code | Item Designation | POWER SERIES | Dimensions (mm) | | | | | | | Price | Master Insert* | |
|---|--------------------|--------------|-----------------|----|----|------|----|----|------|-------|----------------|---|
| | | | D | d1 | d2 | l1 | l2 | l3 | F | | | |
| SMCR/L XCMT | | | | | | | | | | | | |
| 0502../0602../0803../10T3../1304../1705.. | | | | | | | | | | | EURO |  |
| MULTI CUT | | | | | | | | | | | | |
| SM33313 | SMCR 10x2.5 XC05 | ✓ | 10 | 12 | 16 | 25 | 32 | 42 | 5 | 111 € | | XC.. 0502.. |
| SM55025 | SMCL 10x2.5 XC05** | ✓ | 10 | 12 | 16 | 25 | 32 | 42 | 5 | 111 € | | |
| SM33337 | SMCR 12x2.5 XC06 | ✓ | 12 | 16 | 20 | 30 | 40 | 45 | 6 | 113 € | | XC.. 0602.. |
| SM55032 | SMCL 12x2.5 XC06** | ✓ | 12 | 16 | 20 | 30 | 40 | 45 | 6 | 113 € | | |
| SM33344 | SMCR 16x2.5 XC08 | ✓ | 16 | 20 | 25 | 40 | 53 | 50 | 8 | 121 € | | XC.. 0803.. |
| SM55049 | SMCL 16x2.5 XC08** | ✓ | 16 | 20 | 25 | 40 | 53 | 50 | 8 | 121 € | | |
| SM33399 | SMCR 20x2.5 XC10 | ✓ | 20 | 25 | 34 | 50 | 66 | 55 | 10 | 134 € | | XC.. 10T3.. |
| SM55056 | SMCL 20x2.5 XC10** | ✓ | 20 | 25 | 34 | 50 | 66 | 55 | 10 | 134 € | | |
| SM33405 | SMCR 25x2.5 XC13 | ✓ | 25 | 25 | 34 | 62.5 | 80 | 55 | 12,5 | 158 € | | XC.. 1304.. |
| SM55063 | SMCL 25x2.5 XC13** | ✓ | 25 | 25 | 34 | 62.5 | 80 | 55 | 12,5 | 158 € | | |
| SM33757 | SMCR 32x2.5 XC17 | ✓ | 32 | 32 | 44 | 80 | 95 | 60 | 16 | 161 € | | XC.. 1705.. |
| SM55070 | SMCL 32x2.5 XC17** | ✓ | 32 | 32 | 44 | 80 | 95 | 60 | 16 | 161 € | | |

| Size Designation | Master Insert* | Spare Parts | | |
|------------------|---|---|---|---|
| | | Screw | Torx Key | Screw Torque Value |
| |  |  |  |  N-m |
| D10 | XC.. 0502.. | SSV M2x5-9502 | STK-T06-9906 | 0,6 |
| D12 | XC.. 0602.. | SSV M2.2x5-9503 | | 0,85 |
| D16 | XC.. 0803.. | SSV M3x6-9507 | STK-T08-9908 | 1,9 |
| D20 | XC.. 10T3.. | SSV M3.5x7-SC-9513 | STK-T10-9909 | 2,9 |
| D25 | XC.. 1304.. | SSV M4.5x11-9518 | STK-T20-9911 | 5,0 |
| D32 | XC.. 1705.. | | | |

*Suitable Insert brand is TGTC

**Left Side / Sol Yön



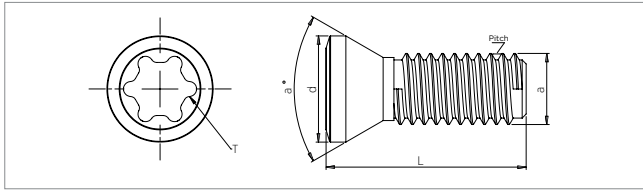

| Stock Code | Item Designation SSV METRIC TORX SCREWS | Dimensions (mm) | | | | | | | Price EURO |
|------------|---|----------------------|-------|-----------------|-------|------|------------|------|---------------|
| | | <i>a</i> (Metric) | Pitch | Drive Size T | L | d | <i>a</i> ° | N.m | |
| SM39216 | SSV M1.8x4-9501 | 1.8 | 0.35 | T06 | 3.95 | 2.7 | 60 | 0,6 | 4 € |
| SM52345 | SSV M2x4-9521 | 2 | 0.4 | T06 | 4 | 2.82 | 60 | 0,6 | 2 € |
| SM22119 | SSV M2x5-9502 | 2 | 0.4 | T06 | 4.85 | 2.82 | 60 | 0,6 | 4 € |
| SM21426 | SSV M2.2x5-9503 | 2.2 | 0.45 | T06 | 5 | 3 | 65 | 0,85 | 4 € |
| SM49536 | SSV M2.5x5-9504 | 2.5 | 0.45 | T08 | 4.85 | 3.5 | 65 | 1,2 | 2 € |
| SM39568 | SSV M2.5x6-9505 | 2.5 | 0.45 | T08 | 5.9 | 3.5 | 65 | 1,2 | 2 € |
| SM21402 | SSV M2.5x7-9506 | 2.5 | 0.45 | T08 | 6.9 | 3.5 | 65 | 1,2 | 2 € |
| SM49673 | SSV M3x6-9507 | 3 | 0.5 | T08 | 6.3 | 3.96 | 60 | 1,9 | 2 € |
| SM39889 | SSV M3x6 LG-9509 | 3 | 0.5 | T08 | 6.4 | 3.94 | 60 | 1,9 | 5 € |
| SM52376 | SSV M3x7-9527 | 3 | 0.5 | T08 | 6.4 | 4.37 | 60 | 1,9 | 2 € |
| SM21464 | SSV M3x8-9508 | 3 | 0.5 | T08 | 7.78 | 3.96 | 60 | 1,9 | 2 € |
| SM27350 | SSV M3.5x8-9510 | 3.5 | 0.6 | T15 | 7.8 | 5.3 | 60 | 2,9 | 2 € |
| SM27367 | SSV M3.5x8-SC-9513 | 3.5 | 0.6 | T10 | 7.78 | 4.80 | 60 | 2,9 | 5 € |
| SM21433 | SSV M3.5x10-9511 | 3.5 | 0.6 | T15 | 10 | 5.3 | 60 | 2,9 | 2 € |
| SM58163 | SSV M3.5x11-9532 | 3.5 | 0.6 | T15 | 10.85 | 5.3 | 60 | 2,9 | 2 € |
| SM53465 | SSV M3.5x12-SC-9531 | 3.5 | 0.6 | T10 | 11.80 | 4.78 | 60 | 2,9 | 5 € |
| SM00180 | SSV M3.5x12-9526 | 3.5 | 0.6 | T15 | 11.80 | 5.27 | 60 | 2,9 | 2 € |
| SM21440 | SSV M3.5x14-9512 | 3.5 | 0.6 | T15 | 13.80 | 5.27 | 60 | 2,9 | 2 € |
| SM29897 | SSV M4x10-9514 | 4 | 0.7 | T15 | 10 | 5.7 | 60 | 4,3 | 2 € |
| SM00470 | SSV M4x9x5-9528 | 4 | 0.7 | T15 | 9 | 5.5 | 60 | 4,3 | 2 € |
| SM21471 | SSV M4x12-9515 | 4 | 0.7 | T15 | 12 | 5.7 | 60 | 4,3 | 4 € |
| SM00487 | SSV M4x12x5-9529 | 4 | 0.7 | T15 | 11.68 | 5.5 | 60 | 4,3 | 2 € |
| SM29934 | SSV M4x12x6-9517 | 4 | 0.7 | T15 | 12.96 | 6.63 | 45 | 4,3 | 5 € |
| SM40083 | SSV M4x14-9516 | 4 | 0.7 | T15 | 13.80 | 5.7 | 60 | 4,3 | 4 € |
| SM21457 | SSV M4.5x11-9518 | 4.5 | 0.75 | T20 | 10.9 | 6.52 | 60 | 5,0 | 4 € |
| SM39193 | SSV M5x13-9519 | 5 | 0.8 | T20 | 12.8 | 7 | 60 | 8,5 | 5 € |
| SM00494 | SSV M5x18-9530 | 5 | 0.8 | T20 | 18 | 7 | 60 | 8,5 | 5 € |
| SM39186 | SSV M6x16-9520 | 6 | 1.0 | T20 | 15.8 | 8.45 | 60 | 10 | 5 € |



| Stock Code | CLAMPS | Item Designation | Price (€) |
|------------|-------------|--|-----------|
| SM21259 | TSK1-9101 | for T System Turning Tools | 8 € |
| SM21297 | TSK2-9102 | for T System Turning Tools | 7 € |
| SM21310 | TSK3-9103 | for T System Turning Tools | 10 € |
| SM21327 | TSK4-9104 | for T System Turning Tools | 11 € |
| SM21358 | TSK5-9105 | for T System Turning Tools | 8 € |
| SM49611 | TSK6-9106 | for T System Turning Tools | 7 € |
| SM01712 | TSK7-9125 | for T System Turning Tools | 7 € |
| SM21266 | MSK1-9107 | for M System Turning Tools | 8 € |
| SM21334 | MSK2-9108 | for M System Turning Tools | 8 € |
| SM21303 | MSK3-9109 | for M System Turning Tools | 8 € |
| SM21303 | MSK4-9110 | for M System Turning Tools | 8 € |
| SM26667 | CSK/R-9112 | for C System Turning Tools | 8 € |
| SM26674 | CSK/L-9113 | for C System Turning Tools | 8 € |
| SM29866 | CSK1/R-9111 | for C System Turning Tools | 8 € |
| SM21280 | CSK1/L-9119 | for C System Turning Tools | 8 € |
| SM21273 | CSK2/R-9113 | for C System Turning Tools | 8 € |
| SM49604 | CSK2/L-9112 | for C System Turning Tools | 8 € |
| SM00159 | CSK3/R-9117 | for C System Turning Tools | 5 € |
| SM00142 | CSK3/L-9118 | for C System Turning Tools | 5 € |
| SM52154 | CSK4-9114 | for C System Turning Tools | 10 € |
| SM52161 | CSK5-9115 | for C System Turning Tools | 10 € |
| SM27206 | RDTP-9124 | for RDMT/RDKW Milling Tools | 1 € |
| SM30008 | TKBP-9116 | for OFER / TPKN / SNGN / SPKN Millng Tools | 6 € |

| Stock Code | LEVERS | Item Designation | Price (€) |
|------------|-----------|--------------------------------------|-----------|
| SM21372 | SPL1-9120 | for WNMG08 / CNMG12 / SNMG12 Inserts | 10 € |
| SM21389 | SPL2-9121 | for CNMG16 / SNMG15 Inserts | 10 € |
| SM27268 | SPL3-9122 | for CNMG19 / SNMG19 Inserts | 10 € |
| SM00173 | SPL4-9123 | for DNMG 1506.. Inserts | 10 € |

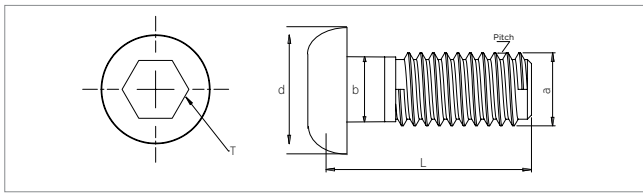



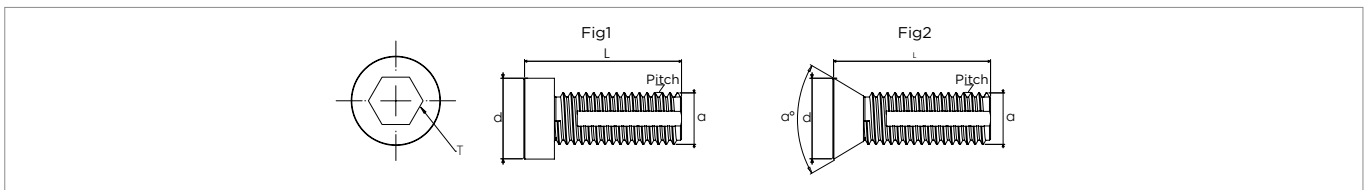











| Stock Code | Item Designation | Dimensions (mm) | | | | | | Price |
|------------|---------------------|----------------------|-------|------------------------|----------|----------|----------|-------|
| | | <i>a</i> (Metric) | Pitch | <i>T</i> Drive Size | <i>d</i> | <i>b</i> | <i>L</i> | |
| | CLAMP SCREWS | | | | | | | |
| SM52192 | TSBV M5x16-9222 | 5 | 0.8 | AA3 | 9.13 | 5.40 | 16 | 2 € |
| SM49574 | TSBV M5x18-9201 | 5 | 0.8 | AA3 | 8.90 | 5.40 | 18.43 | 2 € |
| SM21617 | TSBV M5x24-9202 | 5 | 0.8 | AA3 | 10.85 | 5.35 | 24 | 2 € |
| SM00661 | TSBV M6x27-9203 | 6 | 1.0 | AA3 | 13.80 | 8.15 | 27 | 2 € |
| SM21624 | TSBV M6x30-9205 | 6 | 1.0 | AA3 | 13.80 | 8.15 | 30 | 2 € |
| SM21631 | TSBV M6x30x7-9206 | 6 | 1.0 | AA3 | 13.50 | 7.00 | 30 | 2 € |
| SM21679 | TSBV M8x30-9207 | 8 | 1.25 | AA4 | 13.80 | 8.15 | 30 | 4 € |
| SM52208 | BKTV M4x15-9210 | 4 | 0.7 | AA3 | 6.55 | 3.90 | 15 | 2 € |
| SM52215 | BKTV M5x17-9211 | 5 | 0.8 | AA4 | 8.50 | 4.90 | 17 | 1 € |
| SM52222 | BKTV M5x18x8-9212 | 5 | 0.8 | AA4 | 8 | 4.80 | 18 | 1 € |
| SM52239 | BKTV M6x20x8-9213 | 6 | 1.0 | AA4 | 8.50 | 5.85 | 20 | 1 € |
| SM52246 | BKTV M6x22-9214 | 6 | 1.0 | AA5 | 9.90 | 5.90 | 22 | 1 € |
| SM21648 | BKTV-M6x25-9215 | 6 | 1.0 | AA4 | 9.90 | 5.80 | 25 | 1 € |
| SM59573 | BKTV-M6x26-9233 | 6 | 1.0 | AA5 | 9.90 | 5.80 | 26 | 1 € |
| SM60753 | BKTV-M6x30-9240 | 6 | 1.0 | AA5 | 9.90 | 5.80 | 30 | 1 € |
| SM60760 | BKTV-M6x35-9241 | 6 | 1.0 | AA5 | 9.90 | 5.80 | 35 | 1 € |
| SM52253 | BKTV M8x30x11-9217 | 8 | 1.25 | AA5 | 11.85 | 7.90 | 30 | 1 € |
| SM59566 | BKTV M8x1x25-9232 | 8 | 1.0 | AA4 | 11.50 | 7.90 | 25 | 1 € |
| SM26742 | BKTV-M8x28-9216 | 8 | 1.25 | AA6 | 12.90 | 7.90 | 28 | 1 € |
| SM00197 | CSBV M6x20-9209 | 6 | 1.0 | AA4 | 11.80 | 5.90 | 20 | 1 € |
| SM26759 | CSBV1 M6x26-9223 | 6 | 1.0 | AA5 | 9.90 | 5.90 | 26 | 1 € |
| SM29941 | CSBV M8x30x11-9208 | 8 | 1.25 | AA4 | 11 | 7.80 | 30 | 4 € |
| SM04377 | TKSV M8x1x18-9227 | 8 | 1.0 | AA4 | - | - | 18 | 5 € |



| Stock Code | Item Designation | Dimensions (mm) | | | | | | | | | Price | | |
|------------|--|-----------------|----------------|----------|----------|----------------------|-------|------------------------|----------|----------|-------|----------|------|
| | | Fig. | <i>d</i> | <i>b</i> | <i>L</i> | <i>a</i> (Metric) | Pitch | <i>T</i> Drive Size | <i>d</i> | <i>b</i> | | <i>L</i> | Fig. |
| | MOUNTING SCREWS WITH COOLANT HOLE FACEMILLS | | | | | | | | | | | | |
| SM60692 | STV-C M8x1390-9234 | ✓ | D40 | 8 | 1.25 | AA5 | 13 | 30 | 90 | 1 | 7 € | | |
| SM60708 | STV-C M8x1160-9235 | ✓ | D40* | 8 | 1.25 | AA5 | 11.50 | 30 | 60 | 2 | 7 € | | |
| SM60715 | STV-C M10x1690-9236 | ✓ | D50** D63** | 10 | 1.50 | AA7 | 16 | 30 | 90 | 2 | 7 € | | |
| SM60722 | STV-C M10x1660-9237 | ✓ | D50 D63 | 10 | 1.50 | AA6 | 16 | 30 | 60 | 1 | 7 € | | |
| SM60739 | STV-C M12x1890-9238 | ✓ | D80 | 12 | 1.75 | AA8 | 18 | 40 | 90 | 1 | 10 € | | |
| SM60746 | STV-C M16x2390-9239 | ✓ | D100 | 16 | 2.00 | AA14 | 23 | 50 | 90 | 1 | 10 € | | |
| SM61125 | STV M8x1390-9242 | - | D40 | 8 | 1.25 | AA5 | 13 | 30 | 90 | 1 | 4 € | | |
| SM61132 | STV M8x1160-9243 | - | D40* | 8 | 1.25 | AA5 | 11.50 | 30 | 60 | 2 | 4 € | | |
| SM61149 | STV M10x1690-9244 | - | D50** D63** | 10 | 1.50 | AA7 | 16 | 30 | 90 | 2 | 4 € | | |
| SM61156 | STV M10x1660-9245 | - | D50 D63 | 10 | 1.50 | AA6 | 16 | 30 | 60 | 1 | 4 € | | |
| SM61163 | STV M12x1890-9246 | - | D80 | 12 | 1.75 | AA8 | 18 | 40 | 90 | 1 | 4 € | | |
| SM61170 | STV M16x2390-9247 | - | D100 | 16 | 2.00 | AA14 | 23 | 50 | 90 | 1 | 4 € | | |

INSERT SHIMS

| Item | Order Code | Item Designation | Suitable Insert | Price (€) |
|---|------------|------------------|------------------|-----------|
|  | SM21921 | BAX DN11-9601 | DNMG 11 SHIM | 7 € |
| | SM21792 | BAX DN15-9602 | DNMG 15 SHIM | 7 € |
|  | SM21877 | BAX CN12-9603 | CNMG 12 SHIM | 7 € |
| | SM21907 | BAX CN16-9604 | CNMG 16 SHIM | 7 € |
| | SM21914 | BAX CN19-9605 | CNMG 19 SHIM | 11 € |
|  | SM40014 | BAX WN06-9606 | WNMG 06 SHIM | 7 € |
| | SM21891 | BAX WN08-9607 | WNMG 08 SHIM | 7 € |
|  | SM21822 | BAX SN12-9608 | SNMG 12 SHIM | 7 € |
| | SM21976 | BAX SN15-9609 | SNMG 15 SHIM | 10 € |
| | SM39520 | BAX SN19-9629 | SNMG 19 SHIM | 11 € |
|  | SM21846 | BAX TN16-9610 | TNMG 16 SHIM | 7 € |
| | SM21860 | BAX TN22-9611 | TNMG 22 SHIM | 11 € |
|  | SM21839 | BAX VN16-9612 | VNMG 16 SHIM | 7 € |
|  | SM21808 | BAX DC11-9613 | DCMT 11 SHIM | 7 € |
|  | SM21952 | BAX SC12-9615 | SCMT 12 SHIM | 7 € |
|  | SM27343 | BAX CC09-9616 | CCMT 09 SHIM | 7 € |
| | SM21938 | BAX CC12-9617 | CCMT 12 SHIM | 7 € |
|  | SM21884 | BAX VB16-9618 | VBMT 16 SHIM | 7 € |
|  | SM21983 | BAX TC16-9619 | TCMT 16 SHIM | 7 € |
|  | SM29880 | BAX VC16-9620 | VCMT 16 SHIM | 7 € |
|  | SM21815 | BAX KN16/R-9621 | KNUX/R 16 SHIM | 7 € |
| | SM21969 | BAX KN16/L-9622 | KNUX/L 16 SHIM | 7 € |
|  | SM21853 | BAX ER/L16-9623 | ER/L 16-R/L SHIM | 7 € |
| | SM21990 | BAX ER/L22-9624 | ER/L 22-R/L SHIM | 7 € |
| | SM52451 | BAX IR/L16-9623 | IR/L 16-R/L SHIM | 7 € |
| | SM52468 | BAX IR/L22-9624 | IR/L 22-R/L SHIM | 7 € |
|  | SM39223 | BAX TER16-9625 | TER 16 SHIM | 7 € |
| | SM52475 | BAX TEL16-9626 | TEL 16 SHIM | 7 € |
| | SM39230 | BAX TER 22-9627 | TER 22 SHIM | 7 € |
| | SM52482 | BAX TEL 22-9628 | TEL 22 SHIM | 7 € |
| | SM01408 | BAX TER-27-9630 | TER 27 SHIM | 7 € |
| | SM01415 | BAX TEL-27-9631 | TEL 27 SHIM | 7 € |

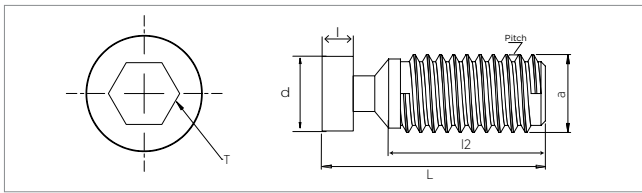

| Stock Code | Item Designation | Dimensions (mm) | | | | | | | Price |
|------------|---------------------|----------------------|--------------|------------------------|----------|----------|----------|-----------|-------------|
| | <i>LEVER SCREWS</i> | <i>a</i> (Metric) | <i>Pitch</i> | <i>T</i> Drive Size | <i>d</i> | <i>L</i> | <i>l</i> | <i>l2</i> | <i>EURO</i> |
| SM22157 | SLV1 M8x20-9224 | 8 | 1.25 | AA3 | 7.90 | 20 | 6 | 10.50 | 6 € |
| SM22164 | SLV2 M8x24-9225 | 8 | 1.25 | AA3 | 7.90 | 24 | 6 | 15 | 6 € |
| SM22171 | SLV3 M10x29-9226 | 10 | 1.50 | AA4 | 9.90 | 29 | 6.80 | 18 | 6 € |
| SM53120 | SLV4 M8x21-9229 | 8 | 1.25 | AA3 | 7.90 | 21 | 4.50 | 12 | 6 € |
| SM58156 | SLV5 M8x19-9231 | 8 | 1.25 | AA3 | 7.90 | 19 | 4.30 | 12 | 6 € |

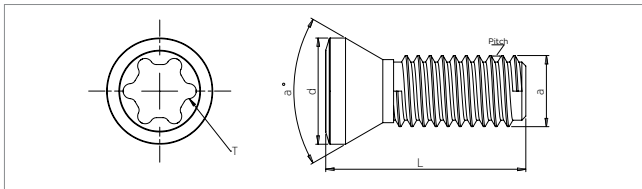

| Stock Code | Item Designation | Dimensions (mm) | | | | | | | Price |
|------------|-------------------------|----------------------|--------------|-------------------|----------|----------|----------|-----------|-------------|
| | <i>BALL NOSE SCREWS</i> | <i>a</i> (Metric) | <i>Pitch</i> | <i>Drive Size</i> | <i>d</i> | <i>b</i> | <i>L</i> | <i>a°</i> | <i>EURO</i> |
| SM21532 | TC170 3x0.5x7-9801 | 3 | 0.5 | T08 | 4.20 | 2.90 | 7 | 50 | 7 € |
| SM21556 | TC172 4x0.5x8-9802 | 4 | 0.5 | T15 | 6 | 3.95 | 8 | 60 | 7 € |
| SM21563 | TC174 5x0.5x9-9803 | 5 | 0.5 | T20 | 7 | 4.95 | 9 | 80 | 7 € |
| SM21570 | TC176 5x0.5x13-9804 | 5 | 0.5 | T20 | 7.40 | 4.95 | 13.50 | 45 | 7 € |
| SM21587 | TC178 5x0.5x17-9805 | 5 | 0.5 | T20 | 7.90 | 4.95 | 17.50 | 45 | 7 € |
| SM21549 | TC181 6x0.75x22-9806 | 6 | 0.75 | AA3 | 9.50 | 5.95 | 22.50 | 60 | 7 € |
| SM21594 | TC184 8x0.75x28-9807 | 8 | 0.75 | AA4 | 11.70 | 7.95 | 28 | 60 | 7 € |

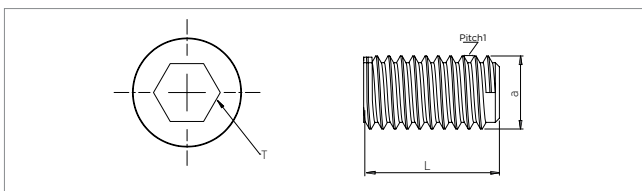

| Stock Code | Item Designation | Dimensions (mm) | | | | Price |
|------------|--------------------------|----------------------|--------------|-------------------|----------|-------------|
| | <i>ADJUSTMENT SCREWS</i> | <i>a</i> (Metric) | <i>Pitch</i> | <i>Drive Size</i> | <i>L</i> | <i>EURO</i> |
| SM52260 | SNSV M3x6-9301 | 3 | 0.5 | AA1.5 | 6 | 2 € |
| SM52277 | SNSV M4x8-9302 | 4 | 0.6 | AA2 | 8 | 2 € |
| SM52284 | SNSV M4x10-9303 | 4 | 0.6 | AA2 | 10 | 2 € |
| SM52291 | SNSV M4x12-9304 | 4 | 0.6 | AA2 | 12 | 2 € |
| SM52307 | SNSV M4x16-9305 | 4 | 0.6 | AA2 | 16 | 2 € |
| SM59306 | SNSV M5x8-9306 | 5 | 0.6 | AA2.5 | 8 | 2 € |
| SM52314 | SNSV M5x15-9307 | 5 | 0.6 | AA2.5 | 15 | 2 € |
| SM52321 | SNSV M5x20-9318 | 5 | 0.6 | AA2.5 | 20 | 2 € |
| SM52338 | SNSV M6x10-9308 | 6 | 1.0 | AA3 | 10 | 2 € |

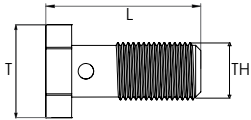

| Stock Code | COOLING ACCESSORY CONNECTION SCREW | | | | Price |
|------------|------------------------------------|----|-------|----|-------|
| | Item Designation | L | TH | T | EURO |
| SM60623 | SMAB G1/8 | 27 | G1/8" | 14 | 3 € |
| SM60630 | SMAB M10x1 | 27 | M10 | 14 | 3 € |

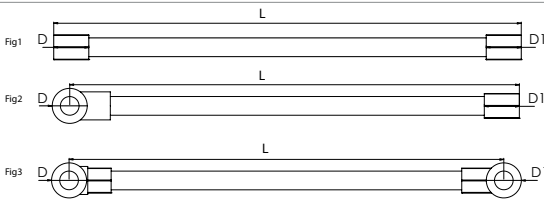

| Stock Code | COOLING ACCESSORY HOSE | | | | | | Price |
|------------|------------------------|-----|-------|-------|------|----------|-------|
| | Item Designation | L | D | D1 | Fig. | Max. Bar | EURO |
| SM60357 | SMDD G1/8-G1/8 | 250 | G1/8" | G1/8" | 1 | 50 | 14 € |
| SM60364 | SMDY G1/8-G1/8 | 250 | G1/8" | G1/8" | 2 | 50 | 14 € |
| SM60371 | SMYY G1/8-G1/8 | 250 | G1/8" | G1/8" | 3 | 50 | 14 € |

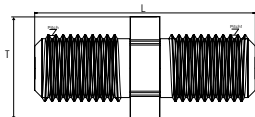

| Stock Code | COOLING ACCESSORY FASTENER | | | | | Price |
|------------|----------------------------|------|-------|--------|----|-------|
| | Item Designation | L | Pitch | Pitch1 | T | EURO |
| SM60388 | SMRK G1/8-G1/8 | 26,5 | G1/8" | G1/8" | 14 | 5 € |
| SM60395 | SMRK1 G1/8-M10x1 | 26,5 | G1/8" | M10x1 | 14 | 5 € |

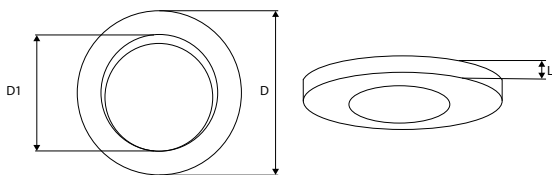

| Stock Code | COOLING ACCESSORY COOPER GASKET | | | | Price |
|------------|---------------------------------|----|----|-----|-------|
| | Item Designation | D | D1 | L | EURO |
| SM60654 | SMBC 1/8 | 14 | 10 | 1,5 | 2 € |

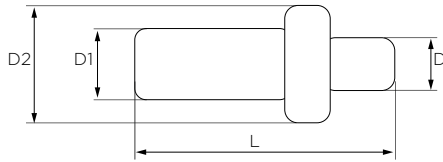

| Stock Code | Item Designation | Dimensions (mm) | | | | Price |
|------------|---------------------|-----------------|-----------|-----------|----------|-------------|
| | <i>SHIM PINS</i> | <i>D</i> | <i>D1</i> | <i>D2</i> | <i>L</i> | <i>EURO</i> |
| SM21228 | BMP1 3.70x5x17-9309 | 3.70 | 5 | 6 | 17 | 2 € |
| SM21235 | BMP2 5x6x16-9310 | 5 | 6 | 7 | 16 | 2 € |
| SM21242 | BMP3 5x6x17-9311 | 5 | 6 | 7 | 17 | 2 € |
| SM59580 | BMP4 3.70x5x12-9322 | 3.70 | 5 | 6 | 12 | 2 € |
| SM49567 | BMP5 3.70x5x13-9312 | 3.70 | 5 | 6 | 13 | 2 € |
| SM49598 | BMP6 5x6x14-9316 | 5 | 6 | 7 | 14 | 2 € |
| SM58460 | BMP7 3.70x5x11-9317 | 3.70 | 5 | 6 | 11 | 2 € |
| SM58477 | BMP8-3.70x5x14-9318 | 3.70 | 5 | 6 | 14 | 2 € |
| SM01835 | TMP1 6x20-9314 | 6 | - | - | 20 | 2 € |
| SM26698 | TMP2 6x24-9315 | 6 | - | - | 24 | 2 € |

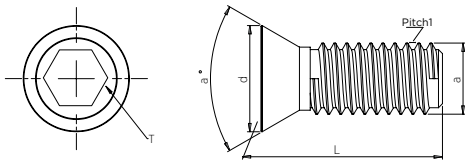

| Stock Code | Item Designation | Dimensions (mm) | | | | | | Price |
|------------|--------------------|----------------------|--------------|-------------------|----------|----------|-----------|-------------|
| | <i>SHIM SCREWS</i> | <i>a</i> (Metric) | <i>Pitch</i> | <i>Drive Size</i> | <i>d</i> | <i>L</i> | <i>a°</i> | <i>EURO</i> |
| SM22003 | TSAV M4x10-9403 | 4 | 0.7 | AA3 | 7.50 | 10 | 30 | 2 € |
| SM39575 | TSAV M4x10x6-9402 | 4 | 0.7 | AA2.5 | 6 | 10 | 30 | 2 € |
| SM58149 | TSAV M4x10x7-9413 | 4 | 0.7 | AA2.5 | 7 | 10 | 30 | 2 € |
| SM52383 | TSAV-M6x16x9-9404 | 6 | 1.0 | AA4 | 9 | 16 | 30 | 2 € |
| SM52390 | TSAV-M6x16x10-9405 | 6 | 1.0 | AA4 | 10 | 16 | 30 | 2 € |
| SM52406 | TSAVM6x16x11-9406 | 6 | 1.0 | AA4 | 11 | 16 | 30 | 2 € |
| SM22027 | CSAV M3x8-9401 | 3 | 0.5 | AA2 | 5.50 | 8 | 30 | 2 € |
| SM00500 | TASV1 M3x9-9220 | 3 | 0.5 | AA2 | - | 9 | - | 2 € |
| SM00227 | TASV1 M4x12-9221 | 4 | 0.7 | AA3 | - | 12 | - | 2 € |

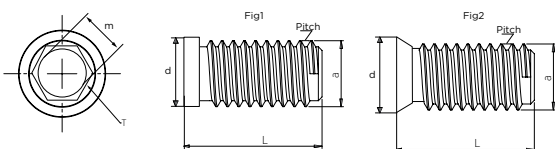

| Stock Code | Item Designation | Dimensions (mm) | | | | | | | Price |
|------------|-------------------------|----------------------|----------|--------------|----------|----------|-------------------|-------------|-------------|
| | <i>SHIM SCREWS</i> | <i>m</i> (Metric) | <i>a</i> | <i>Pitch</i> | <i>d</i> | <i>L</i> | <i>Drive Size</i> | <i>Fig.</i> | <i>EURO</i> |
| SM22034 | SBV M5.05 A3.5x11-9407 | 4 | 5 | 0.5 | 5.85 | 11 | AA3.5 | 1 | 2 € |
| SM52413 | SBV1 M6x0.75 A4x12-9409 | 4 | 6 | 0.75 | 7.50 | 12 | AA4.5 | 2 | 4 € |
| SM22041 | SBV2 M6x0.75 A4x13-9410 | 4 | 6 | 0.75 | 7.50 | 13 | AA4.5 | 1 | 4 € |
| SM52437 | SBV3 M6x0.75 A4x10-9412 | 6 | 6 | 0.75 | 7.50 | 10 | AA4.5 | 1 | 4 € |
| SM52420 | SBV4 M6x0.75 A4x9-9411 | 6 | 6 | 0.75 | 7.50 | 9 | AA4.5 | 2 | 4 € |
| SM49543 | SBV5 M5.05 A3.5x9-9408 | 6 | 5 | 0.5 | 5.85 | 9 | AA3.5 | 1 | 2 € |

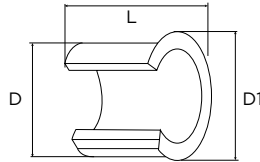

| Stock Code | Item Designation | Dimensions (mm) | | | Price |
|------------|---------------------|-----------------|-----------|----------|-------------|
| | <i>SHIM SPRINGS</i> | <i>D</i> | <i>D1</i> | <i>L</i> | <i>EURO</i> |
| SM21525 | SLAY1-9701 | 6.50 | 7.45 | 6.20 | 2 € |
| SM26740 | SLAY2-9702 | 7.75 | 9 | 8.15 | 2 € |
| SM29927 | SLAY3-9703 | 9.80 | 11.20 | 11.25 | 2 € |

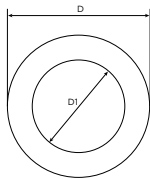

| Stock Code | Item Designation | Dimensions (mm) | | Price |
|------------|----------------------------|-----------------|-----------|-------------|
| | <i>CLAMP SCREW SPRINGS</i> | <i>D</i> | <i>D1</i> | <i>EURO</i> |
| SM21501 | TSP 6.5x12-9705 | 12 | 6.50 | 3 € |



| Stock Code | Item Designation | Price |
|------------|------------------|-------------|
| | <i>Cartridge</i> | <i>EURO</i> |
| SM16125 | KR2024 | 70 € |
| SM16132 | KR2429 | 70 € |
| SM16101 | KR2939 | 73 € |
| SM16149 | KR3949 | 77 € |
| SM16156 | KR4960 | 77 € |
| SM16163 | KR5979 | 80 € |
| SM16118 | KR6989 | 92 € |
| SM16170 | KR89130 | 100 € |



| Stock Code | Item Designation | Price |
|------------|----------------------------|-------------|
| | <i>TORX and ALLEN KEYS</i> | <i>EURO</i> |
| SM21761 | STK-T06-9906 | 2 € |
| SM21716 | STK-T08-9908 | 2 € |
| SM00357 | STK-T10-9909 | 2 € |
| SM27251 | STK-T15-9910 | 2 € |
| SM21778 | STK-T20-9911 | 2 € |
| SM21754 | SAK-AA3-9902 | 2 € |
| SM21723 | SAK-AA4-9903 | 2 € |
| SM21730 | SAK-AA5-9904 | 2 € |
| SM21747 | SAK-AA6-9905 | 2 € |
| SM58095 | SBK-01-9901 | 8 € |



SMOXH[®]
CUTTING TOOLS



SMOXH[®]
CUTTING TOOLS



SMOXH[®]
CUTTING TOOLS



the best
value of
process



Mustafa Şimşek Makine Takım San. Tic. Ltd. Şti. reserves innovation and revision rights on products specified in the catalogue without notifying them.
Mustafa Şimşek Makine Takım San. Tic. Ltd. Şti. bilgilendirme gereksinimi duymadan istediği zaman katalogdaki ürünler üzerinde değişiklik ve düzeltme yapma hakkını saklı tutar.

- All rights reserved.®
- Tüm hakları saklıdır.®



Mustafa ŞİMŞEK Makine Takım San. Tic. Ltd. Şti.

Fevzi Çakmak Mh. Sıla Cad. No:46/G-42050 Karatay/Konya/TURKEY

+90 332 251 21 78 +90 332 251 21 79 info@smoxh.com.tr export@smoxh.com.tr



www.smoxh.com.tr